

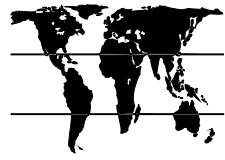

DTU   **KENDAT**

Animal Cart Programme

TECHNICAL
48
RELEASE

Simple Chain and Wood Saddle for Donkeys

Development Technology Unit, Department of Engineering, University of Warwick, Coventry, CV4 7AL UK, tel: +44 (0)1203 523523 extn 2339, fax: +44 (0)1203 418922, email: dtu@eng.eng.warwick.ac.uk
KENDAT, PO Box 61441, Nairobi, Kenya, tel/fax: +254 2 766939, email: kendat@africaonline.co.ke

Figure 1: locally made chain and wood block saddle for donkeys.



Chain and wood block saddle for donkeys.

Introduction

This chapter covers a simple but effective saddle design for donkeys pulling carts, though it can be used for other purposes as Figure 2 shows. Saddles are necessary in a cart harness because vertical loads must be applied by the animal to stabilise the cart. We have adapted the saddle shown here only slightly from a design used by many farmers in the Mwea area in Kenya.

This saddle is extremely easy to make. All you need is some light chain (made from 2mm or 4mm steel wire) some wood and some fencing nails (U-nails). The only tools which you must have are a woodsaw and hammer. You will probably find that you can make the saddle for one donkey for about £_{UK}3 for a version for use with agricultural implements or about £_{UK}6 if you need to make up the belly and breeching straps for use with carts. You can probably make a saddle in only a couple of hours.

Idea behind chain saddles

Saddles are used to apply downwards load from a cart or from an agricultural implement onto donkeys. Saddles must be used because donkeys' backs are easily damaged by things put on

them. Fat donkeys will be much more resistant to injury, but donkeys in poor condition have much thinner muscles on their backs and this tends to expose their backbones. Any hard object (even a strap) just stretched over their backs can cause damage as the skin over their backbone is compressed. After some time this pressure will damage the skin and infection can start which can kill the donkey.



Figure 2: simple version of chain saddle used with steel version of straight hame donkey collar.

A properly shaped saddle will protect the vulnerable area of skin and put the load onto the muscles which cover part of its back. Figure 3 represents an animal in good condition and Figure 4 shows the vulnerable area of skin above the backbone. A saddle must be shaped on the underside to keep clear of this vulnerable skin.

Cutting list and costs

Tables 1 shows a cutting list for a saddle with recent prices of materials in Kenya converted into £_{UK}.

TABLE 1: steel straight hame collar materials cutting list.

component	material	# components	mat cost [£ _{UK}]
chain	dog or round wire chain	1	1.40
wooden blocks	100 x 50 mm roughsawn	4 x 250	0.40
padding	blanket/ sacks	2	0.80
U-nails	U-nails	¼ kg	0.60
strap hooks	6mm re bar	2x150	0.03
strap rings	6mm re bar	6x180	0.11
strap clenchers	6mm re bar	6x120	0.07
strap hooks	6mm re bar	6x150	0.09
straps	CC5 canvas	3x4x65	1.97
strap chains	dog chain	3x300	0.70
		TOTAL =	6.14

Construction step by step

- 1) Get all the material together and clear a space to work. Ideally you will be able to work on a flat area of concrete or have access to a bench and vice. It is also easiest if you have the donkey standing by to try the saddle fitting out and position things.
- 2) Cut four pieces of 100 x 50 roughsawn timber 250 mm long and round off all the corners with a file or carpenter's plane.

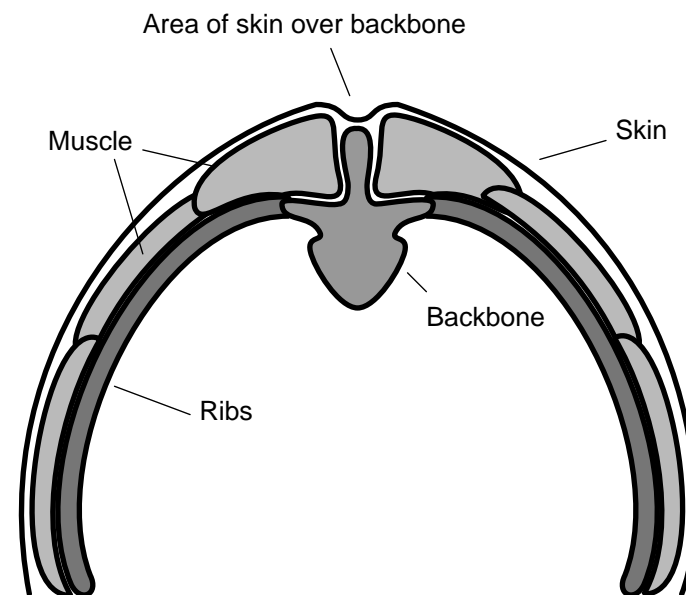

Figure 3: skin over the backbone of donkey in good condition is not vulnerable.

- 3) Using U-nails, fix each of the top wooden blocks 75 mm either side of the centre of the chain and the other two blocks a further 75 mm away from them as shown in Figure 5.
- 4) Make up the padding from blanket or natural fibre sacks (DO NOT USE PLASTIC SACKS). You can either leave this padding separate from the saddle or you can nail it on to the wooden blocks. If you nail it, you must use another

layer of cloth under the the nailed padding to make sure the nails do not touch the animal.

- 5) It may be easier to fix the saddle to the rest of the harness if you make up two of the hooks shown in Figure 6 and fit one to each end of the chain.

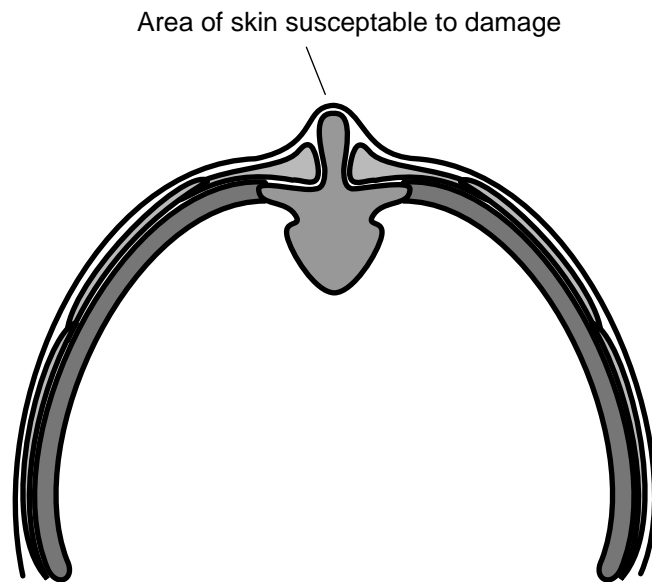

Figure 4: skin over backbone of donkey in poor condition is very vulnerable.

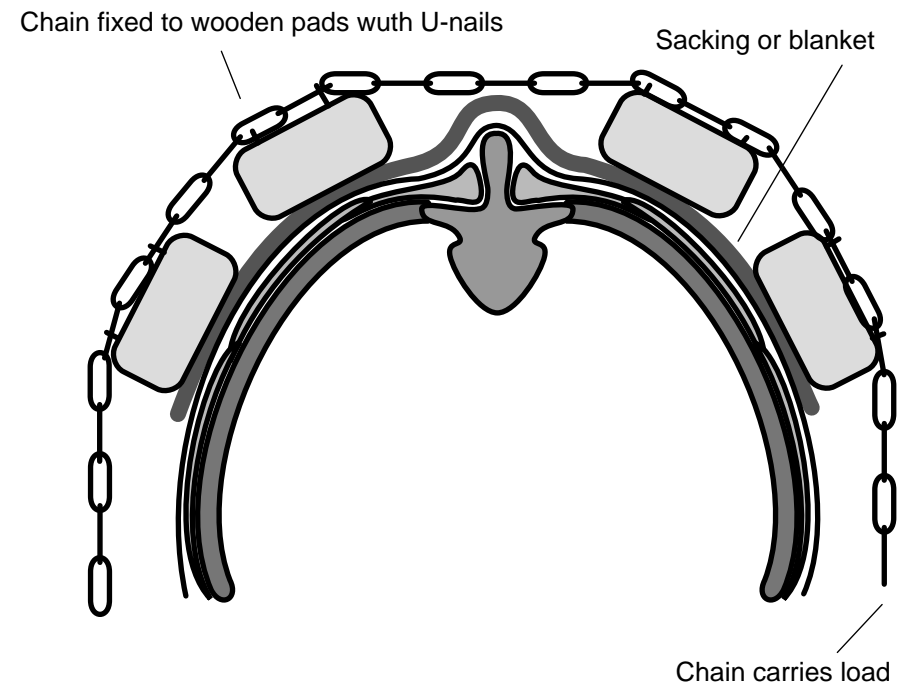

Figure 5: height of wooden blocks keeps chain away from backbone. Note sacking/ blanket padding.

- 6) If you are going to use belly, breeching and breast straps for cart use, make up six more of these hooks and fit one to the chain between the wooden blocks on each side, and one to the chain just below the lower wooden blocks, as shown in Figure 7.
- 7) If you are going to use the saddle for pulling carts make up a belly strap, a breeching strap and a breast strap to hold the saddles onto the donkeys. The D rings at the end of the straps can be made from 6 mm diameter concrete reinforcing bar as shown in Figure 8. A separate piece of the re-bar is clenched over the strapping using hammer blows to fix the D rings to the ends of the straps as shown. The straps themselves can be made from heavy canvas or

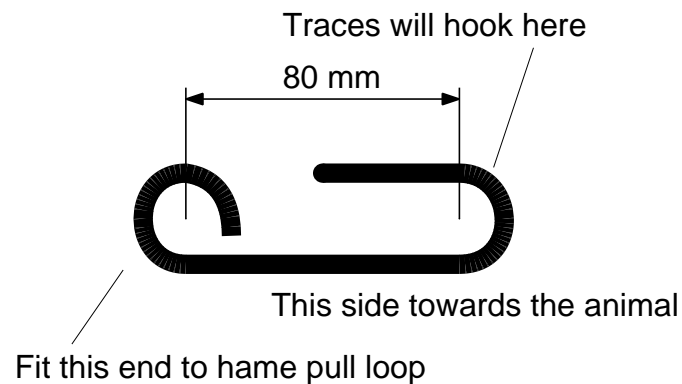

Figure 6: chain hooks for straps.

TR 48: 25th December 1999

hessian sacking. You should use three or four thicknesses of material for them to make them strong enough and soft enough not to hurt the donkey.

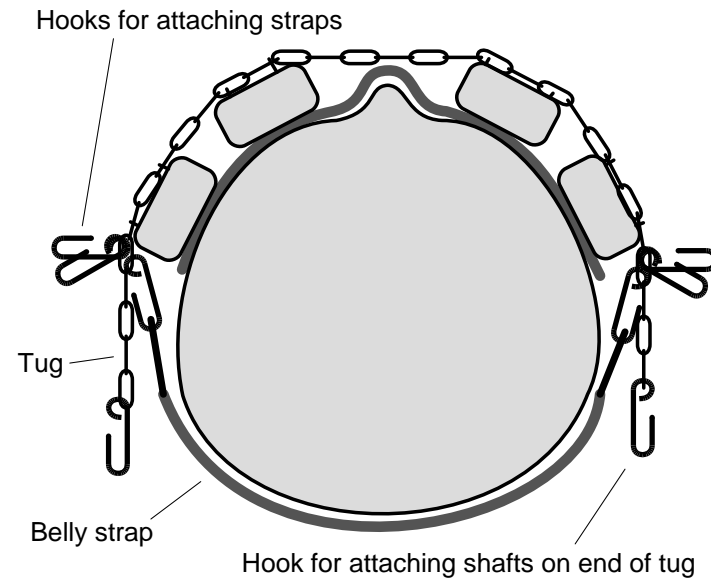

Figure 7: arrangement of attachment hooks for straps and shafts on saddle chain.

Using the saddle with agricultural implements

(Remember that protecting the donkey will save money because it can work harder if it is comfortable and will not get sick from skin wounds.)

Agricultural implements normally demand high draught and this is usually only available using a collar harness of the type described in our Technical Release 46. Breast straps are difficult to use with most donkeys because their chest are poorly proportioned for this work. It is even worse if you want them to pull hard.

It is usually easier to use a saddle with agricultural implements (plough or weeder etc) because the ideal angle for the traces is

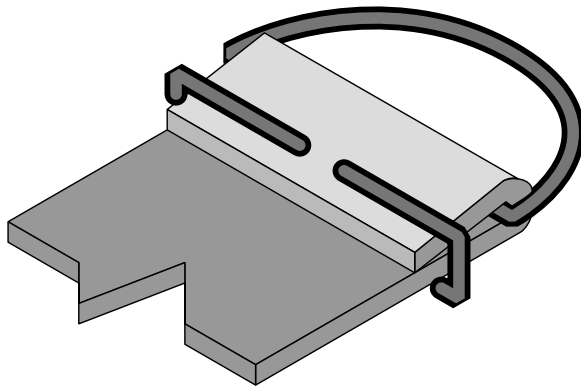

Figure 8: D rings for straps made from re-bar.

rarely the same as the ideal angle for the implement and, using a saddle, these can be adjusted independently. Figure 9 shows the general layout of harness when using the saddle with a collar.

- 1) Place the saddle on the donkey's back using a separate piece of blanket or sacking under any nailed on padding.
- 2) Check that there is plenty of room under the chain you must be able to get two fingers under the chain - it **MUST NOT TOUCH THE DONKEY'S BACK!** Figure 10 shows a poorly arranged saddle with one of the wooden blocks nearly over the backbone.

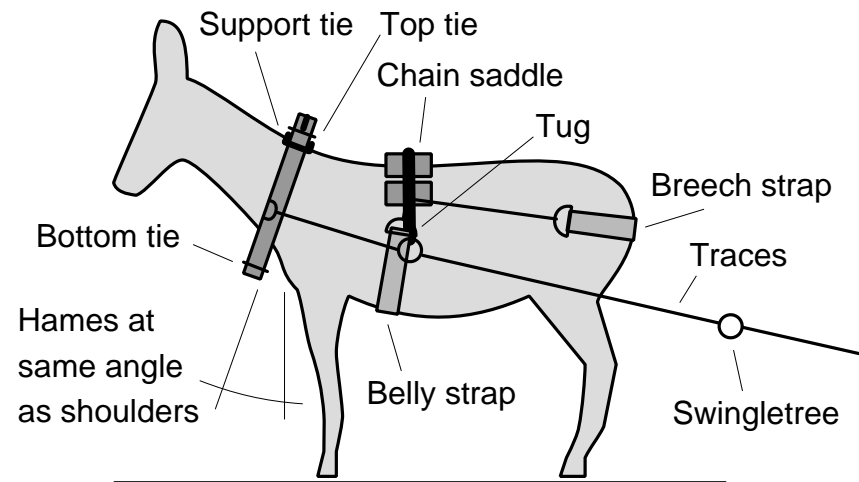

Figure 9: saddle and collar position on donkey with traces pulling at right angles to hames.

- 3) Adjust the lengths of the tugs (the ropes or straps hanging from the saddle if you use one) so that the traces (the ropes or chains which will pull the cart or implement) come back at right angles to the animal's shoulder blades (see Figure 9).
- 4) Fit the breeching strap if you find that the saddle rides forward as you work, but you will usually find that the backward pull on the tugs keeps it in place.



Figure 10: inadequate height of wooden blocks and poor positioning endangers skin over backbone. The sacking/padding is also poor.

TR 48: 25th December 1999

Saddle use with carts

(Remember that protecting the donkey will save money because it can work harder if it is comfortable and will not get sick from skin wounds.)

If you are going to pull a cart you must use a saddle because the cart will need some up or down force to stabilise it. A donkey's back needs the protection that a saddle gives against this force. If people just use neck yokes in your area you will usually see damage on the necks and shoulders of their donkeys.

Figure 11 shows a typical arrangement of breast band, saddle, and

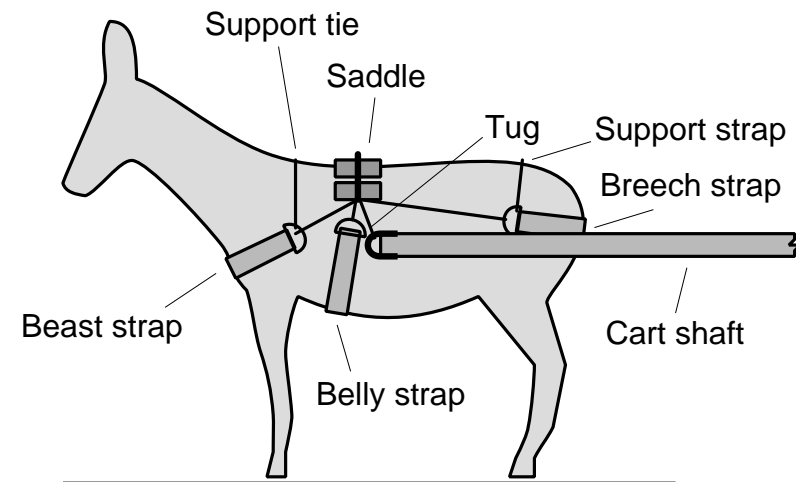

Figure 11: attachment of saddle to cart and use of breast strap.

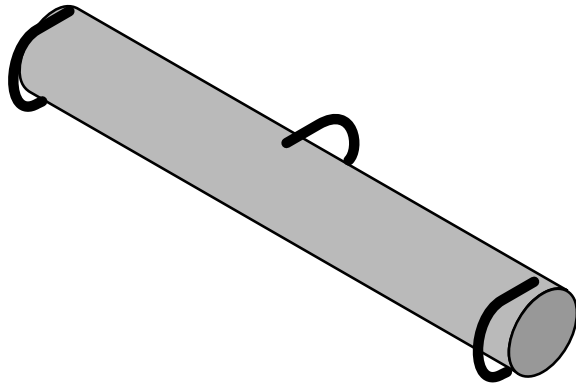

Figure 12: swingletree: the traces will be tied to the ends, and the cart or implement tied to the central loop.

belly strap, breeching strap, tugs and cart shafts.

Using a breast band to pull the cart is usually acceptable, but if the cart is very heavy then you should use the collar described in our Technical Release 46.

- 1) Place the saddle on the donkey's back using a separate piece of blanket or sacking under any nailed-on padding.
- 2) Using two of the hooks shown in Figure 6 attach the belly strap. It should be quite tight so that it does not move during work.
- 3) Check that there is plenty of room under the chain over the backbone: you must be able to get two fingers under the

chain - it **MUST NOT TOUCH THE DONKEY'S BACK!**

- 4) Attach the breeching strap to two of the hooks just below the lower wooden blocks. Tie a piece of rope or cord across from the D-ring in one end of the breeching strap to the D-ring of the other so that the strap will not fall out of position if the strap goes slack. The breeching strap will be nearly loose.
- 5) Now bring the shafts of the cart either side of the donkey and attach the tugs to the shafts so that the cart is level.
- 6) Lastly attach the breast band to another pair of hooks below the wooden blocks of the saddle or lead traces (pieces of rope or chain) from the ends of the breast strap to a swingletree on the front of the cart. A swingletree is shown in Figure 12. Use of the swingle tree is kinder to the animal because it allows a little movement of the breast strap with the movement of the animals chest as it moves. Make sure that the traces do not rub against the sides of the animal.

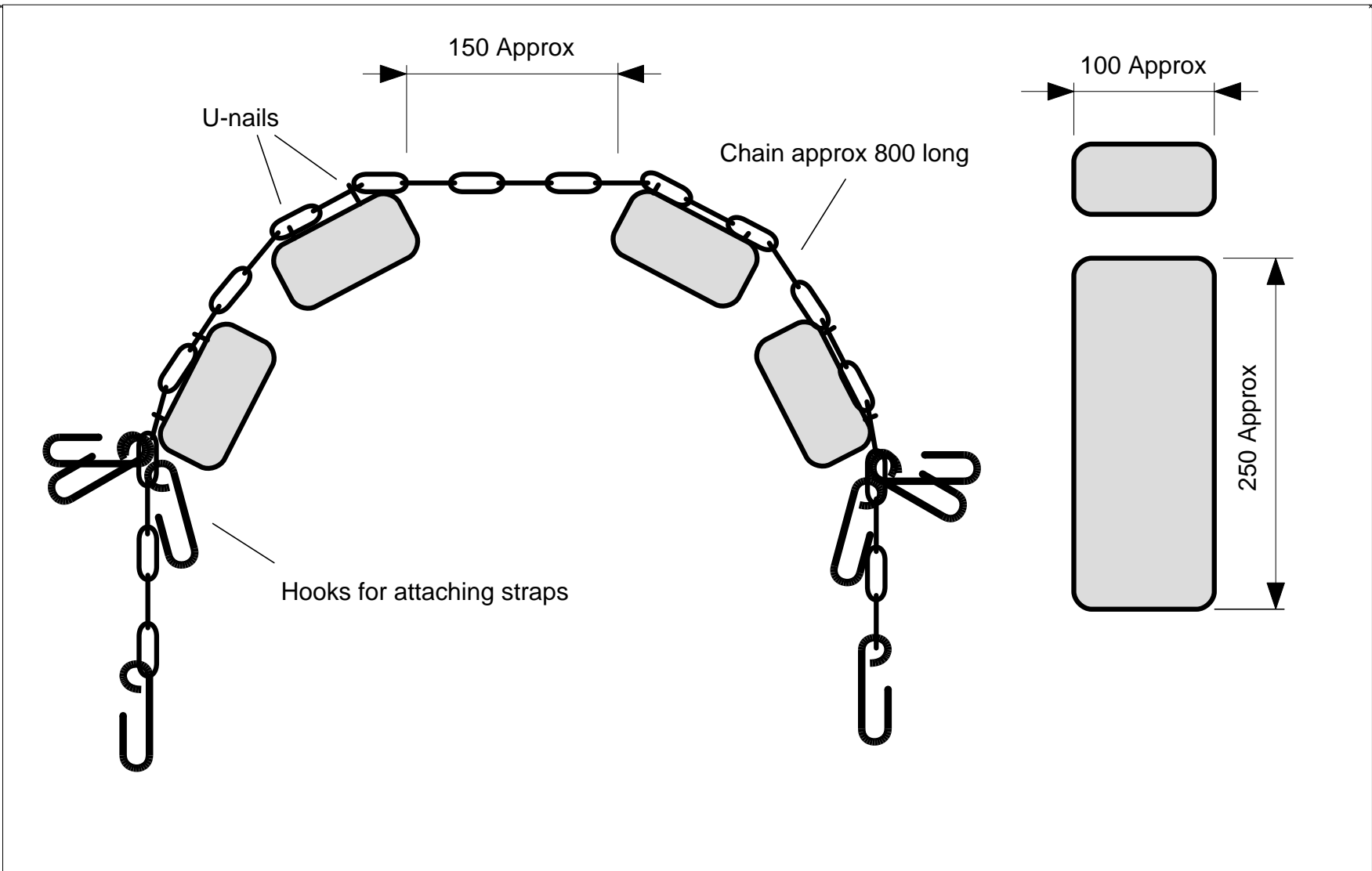

					Scale	25 mm 	Title Chain saddle for donkeys	Drawn by	CEO
					Date	25/12/99		Dwg No	1/1

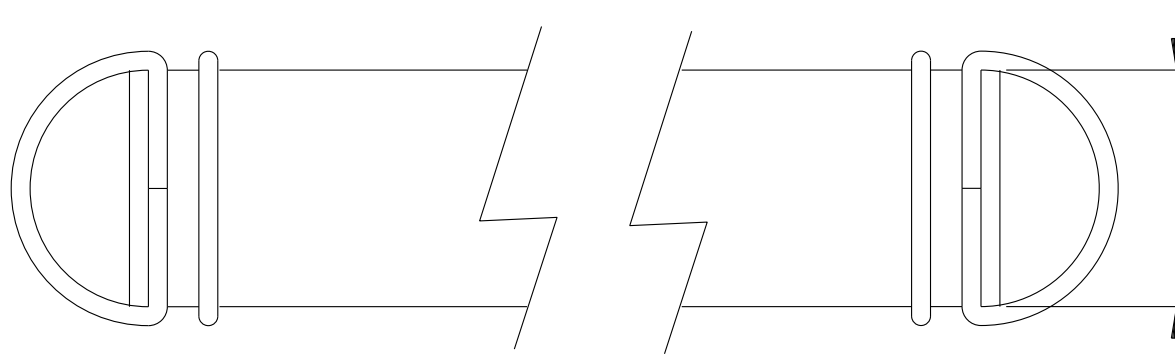

STRAPS

65

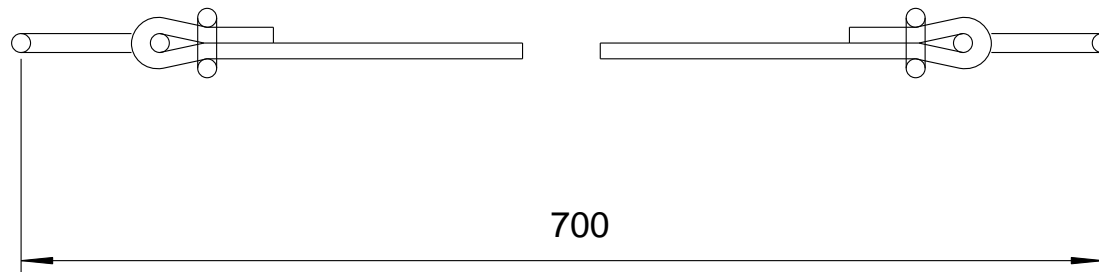

700

					Scale	25 mm	Title	Drawn	CEO
					Date	25/12/99		Straps	Dwg #