

# **AT** MICROFICHE REFERENCE LIBRARY

A project of Volunteers in Asia

Ferrocement, a Versatile Construction Material:  
Its Increasing Use in Asia

by: Ricardo P. Pama, Seng-Lip Lee and Noel D.  
Vietmeyer

Published by:

International Ferrocement Information Center  
Asian Institute of Technology  
P.O. Box 2754  
Bangkok  
Thailand

Paper copies are \$ 2.00.

Available from:

International Ferrocement Information Center  
Asian Institute of Technology  
P.O. Box 2754  
Bangkok  
Thailand

Reproduced by permission of the Library and  
Regional Documentation Centre, Asian Institute of  
Technology.

Reproduction of this microfiche document in any  
form is subject to the same restrictions as those  
of the original document.

**Refracement,  
a Versatile Construction  
Material:  
Its increasing use  
in Asia**

**Edited by  
Ricardo P. Pama  
Seng-Lip Lee  
and  
Noel D. Vietmeyer**

**Asian Institute of Technology  
Bangkok, Thailand  
1976**

**FERROCEMENT, A VERSATILE CONSTRUCTION MATERIAL:  
ITS INCREASING USE IN ASIA**

**A Report of the Workshop on Introduction of Technologies  
in Asia - Ferrocement, A Case Study  
November 5 - 8, 1974  
Bangkok, Thailand**

*Sponsored by*

**NATIONAL ACADEMY OF SCIENCES  
ASIAN INSTITUTE OF TECHNOLOGY**

*Edited by*

**Ricardo P. Pama  
Seng-Lip Lee  
and  
Noel D. Vietmeyer**

**Asian Institute of Technology  
Bangkok, Thailand  
1976**

## WORKSHOP COORDINATORS

S.L. Lee                      R.P. Pama  
Asian Institute of Technology  
Bangkok, Thailand

N.D. Vietmeyer  
National Academy of Sciences  
Washington, D.C., U.S.A.

## WORKSHOP PANEL

J. Romualdi, Chairman  
Carnegie-Mellon University  
Pittsburgh, Pennsylvania, U.S.A.

W.F. Chang  
University of Miami  
Coral Gables, Florida, U.S.A.

A.U. Khan  
International Rice Research Institute  
Los Banos, Laguna, Philippines

H.J. Larsen, Jr.  
Larsen and Ludwig, Engineers and Architects  
Pittsburgh, Pennsylvania, U.S.A.

R.B.L. Smith  
University of Nairobi  
Nairobi, Kenya

## PREFACE

This report is the product of the workshop "Introduction of Technologies in Asia-Ferrocement, A Case Study," jointly sponsored by the Asian Institute of Technology (AIT) and the U.S. National Academy of Sciences (NAS) and held on the AIT campus in Bangkok, Thailand, November 5-8, 1974.

Through the Board on Science and Technology for International Development (BOSTID); the NAS has long been concerned with the uses of science and technology in relation to problems of economic and social development. AIT, an institution for graduate studies in engineering and other related fields, has a distinguished record of achievement in education and research, along with an institutional commitment to use its resources to further both the understanding and the development of solutions to development problems in Asia.

Ferrocement technology is an especially apt topic for collaboration between AIT and the NAS because the Academy has published a report on ferrocement, while the Division of Structural Engineering and Materials at AIT had conducted extensive ferrocement research.

The workshop brought together engineers, scientists, administrators, and businessmen and gave them the opportunity to exchange views on, and experience with, ferrocement. The workshop's basic purposes were:

- o to survey both the state of the art of ferrocement technology and its applications important to Southeast Asia;
- o to provide information on ferrocement research and development taking place in Asia and to share the knowledge and experience gained thus far;
- o to discuss the most promising methods of introducing ferrocement technology to Asia from the point of view of effectiveness, cost, and social acceptability;
- o to recommend areas of technical and social research that need to be carried further with respect to ferrocement.

Demonstrations of ferrocement construction were held during the workshop. Fifty five participants from 17 nations attended. Immediately following the workshop, a demonstration for the benefit of some 50 village heads from several districts in Pathumtani province was held.

This workshop was supported by:

- o United States Agency for International Development(AID):
  - Office of Science & Technology, Bureau for Tech. Assist., Washington
  - Office of Regional Economic Development(RED), Bangkok, Thailand
- o The Government of New Zealand
- o Firth Industries New Zealand Limited
- o United Nations Industrial Development Organization(UNIDO)
- o United Nations Food and Agriculture Organization(FAO), Rome, Italy
- o Intermediate Technology Development Center, London, England

## TABLE OF CONTENTS

	Page
Summary of Workshop .....	1
Appendix A .....	14
Workshop Participants	
Appendix B .....	18
Design Philosophy for Ferrocement by R.B.L. Smith	
Appendix C .....	22
Ferrocement Research and Development in Tamil Nadu, India by T. Kanakasabapathy	
Appendix D .....	34
A Korean Experience in Ferrocement Boats by Hun Chol Kim	
Appendix E .....	39
Ferrocement Roofing Research in the Philippines by P.B. Mejia and R.T. Tola	
Appendix F .....	44
Ferrocement Boat Building in Fiji by A. Sannergren	
Appendix G .....	47
Rice Bin for Rural Farmers by O. Phromratanapongse	
Appendix H .....	51
Ferrocement Boat Construction at the Royal Thai Navy Shipyard by T. Makarananda, S. Sarakashetrin and V. Chomchuenchit	
Appendix I .....	54
Ferrocement Housing in Papua, New Guinea by H.M. Moar	
Appendix J .....	56
Ferrocement Construction in Bangladesh by G.W. Bigg	

## TABLE OF CONTENTS

	Page
<b>Appendix K</b> .....	84
Water Jars of Cement Mortar by O. Phromratapongse	
<b>Appendix L</b> .....	92
Development and Application of Ferrocement in Sri Lanka and Malaysia by A.N.S. Kulasinghe	
<b>Appendix M</b> .....	96
Ferrocement Developments and Applications in India by H.C. Visvesvaraya	
<b>Appendix N</b> .....	100
Ferrocement Research and Development at University of Singapore by P. Paramasivam, G.K. Nathan and S.L. Lee	

## SUMMARY OF WORKSHOP.

Ferrocement is a highly versatile form of reinforced concrete made of wire mesh, sand, water, and cement, which possesses unique qualities of strength and serviceability. It can be constructed with a minimum of skilled labor and utilizes readily available materials. Proven suitable for boatbuilding, it has many other tested or potential applications in agriculture, industry and housing.

Ferrocement is particularly suited to developing countries for the following reasons:

- o Its basic raw materials are available in most countries.
- o It can be fabricated into almost any shape to meet the needs of the user; traditional designs can be reproduced and often improved. Properly fabricated, it is more durable than most woods and cheaper than imported steel, and it can be used as a substitute for these materials in many applications.
- o The skills for ferrocement construction are quickly acquired, and include many skills traditional in developing countries. Ferrocement construction does not need heavy plant or machinery; it is labor-intensive. Except for sophisticated and highly stressed designs, as those for deepwater vessels, a trained supervisor can achieve the requisite amount of quality control using fairly unskilled labor for the fabrication.

To the engineer ferrocement offers a tough, durable material that has low permeability, that can be formed into any desired shape, that has high impact resistance and that is easy to repair if damaged.

Although ferrocement structures were first built in the 1840's, the material has been in widespread use only in the last two decades. The main applications of ferrocement are in constructing boats, roofs, and silos. More ferrocement structures have been built in the Asian-Pacific region than elsewhere in the world. Some applications of ferrocement in the Asian-Pacific region are described in the Appendices.

Ferrocement has to compete with other construction materials. In some locations, the competition will be inexpensive, as in thatch for roofing in rural areas. In others it will be expensive, as in corrugated iron roofing in urban areas. The same applies to actual uses: in some the competition will be inexpensive, i.e. a wicker-and-mud silo, and it will be expensive in others, for instance, fiber-glass boats.

The economics of ferrocement construction must always be considered in the light of the quality of the product desired, of the location, and of the competitive materials available. Furthermore, many of the alternatives may use traditional materials whose use is deeply rooted in the culture of the region. Some examples of alternative materials to ferrocement are given in Table 1.



## Boats

Ferrocement boats have by now been built in almost every Asian country, as shown in Table 2. A few typical examples are shown in Figures 1 to 6. This is a considerable development compared with the situation five years ago, when hardly any country outside China had built ferrocement boats. However, China still remains the only country where ferrocement boats have been introduced on a large scale. In the other countries ferrocement occupies only a fraction of a percent of the total boat building market.

There are many people involved in ferrocement boat building in Asian countries. The workshop's subgroup on boat construction addressed the question of what could be done to make the work of these people more effective in the future. One answer that was supported unanimously was the establishment of a ferrocement information center. This information center would keep a register of people working in the field, would reply to technical inquiries, and would distribute a newsletter describing new projects and new results.

Ferrocement, like any other construction material, has strong and weak points, and it is important that the material is applied to boat types and boat size where its characteristics are best utilized. Ferrocement is a relatively heavy material, compared with wood and fiber reinforced plastic (FRP). Most wooden boats below 10m length are built with a plank thickness of less than 25mm. To obtain the same weight in ferrocement one would have to utilize a hull thickness of only 8 mm. Although small ferrocement boats have been built with a hull of this thickness the impact resistance is not satisfactory for a work boat used in fishing or transport. At its present state of development, ferrocement has proved most suitable for boats above 10m. Even in these larger sizes, a ferrocement boat will be heavier than a wooden boat, but this is of little disadvantage at moderate speeds. For a boat of 10m moving at 6 knots, the power per ton of weight is around 3 Hp. If the speed is increased to 8 knots, the power per ton increases to 6 Hp. For the lower speed the extra weight of a ferrocement boat makes little difference, although for higher speed the extra weight will require increased power. Boats that are not mechanized, such as poled or rowed river boats, do not have speeds higher than 3-4 knots and for these low speeds the extra weight of ferrocement makes very little difference in the effort of propulsion.

The ferrocement sampans used in China are a good example of the latter type. The largest of these boats have a length of 15m with 10 tons cargo capacity, yet they are still manpowered.

To sum up: Ferrocement at its present state of development is most suitable for boats longer than 10 m when a speed between 6.5 and 10 knots is required.

Probably about 75 percent of all fishing boats in Asia are wooden boats below 10m in length that are frequently hauled out of the water. Ferrocement is not a good material for replacement of these boats, but it will in many cases be a good option for larger fishing boats propelled with a moderate power inboard diesel engine. Ferrocement should therefore find a good market in transport boats used on rivers and canals. The example of China demonstrates well enough the potential of ferrocement for 10-15m barges poled and or towed. In Asia the use of ferrocement for river and canal transport boats should receive the greatest attention.

Quality control is essential in the first stage of introducing ferrocement boat building in a country. One can envisage less strict quality controls for boats operating on rivers and canals than for boats used in the open sea, since both the stresses and the risks are higher for the latter. It is wise to be prudent in the introduction of the material since initial failure will seriously setback its further development.

The construction of a conventional ferrocement boat can be subdivided into the following phases:

1. Drawing of the frames in full size
2. Bending and welding of frames
3. Setting up of frames
4. Applying rods and mesh
5. Plastering
6. Curing

Supervision is required in all stages of construction but special work skills are only required in stages 1, 3 and 5. The main bulk of the work falls in stage 4, which can be done with unskilled labor. This is a major advantage of ferrocement over wood and steel. Assuming that the construction is done under the supervision of a trained ferrocement boat builder, the quality control applies mainly to stage 5, plastering. Experience has shown that the quality of mortar and its application is the most critical phase. Lack of penetration of the mortar leads to voids and later ingress of water and rusting of the reinforcement.

To achieve sufficient quality control in the initial stage of introducing ferrocement, one should try to concentrate the building in a central place rather than establishing boat yards in every major village. Only after the introduction of ferrocement boats has been consolidated, the boat types developed and the market identified, can one branch out into new areas. In this second phase one can foresee the central manufacture of frame sets and the local building of the boats with special assistance during plastering.

### Agricultural Uses

The following applications were considered by the subgroup on agricultural uses:

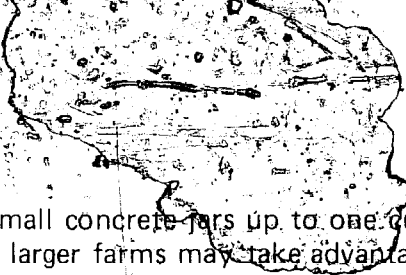
1. Grain storage containers
2. Water storage containers, and
3. Other structures.

**Grain Storage.** Traditional storage methods and their relative effectiveness against loss by birds, insects, rodents and mold, differ from country to country. The storage needs of the small farm consist of the residues beyond what it sold immediately after harvest. This includes domestic requirements plus what can be kept to sell later. For storage on this scale containers of 3-10 tons capacity are needed. Cheaper alternatives to ferrocement appear to be feasible using wire fiber, bamboo reinforcement, or plain mortar, such as the rice bin shown in Figure 7. Also some traditional methods which are used in Bangladesh, for example, retain the advantages of economic construction, low permeability and durability, and with little maintenance cost.

The potential for using ferrocement silos exists more definitely at the village or communal level. This could be either as a collection of individual bins similar to the Thailand shown in Figure 8, or as a single silo of about 100 tons capacity similar to the Cyprus bins or to the long Argentine silos. This larger unit could include facilities for drying the grain. This would be essential, for example, in Thailand, where the second rice crop has to be harvested in the rainy season when the farmers have no way of drying the crop.

**Water Storage.** In many parts of the world, where at present water has to be collected daily over long distances by human labor, there is great need for storage of drinking water

4



collected from rainfall. Small concrete jars up to one cubic meter capacity are useful for rain water collection. But larger farms may take advantage of tanks of 2 cu.m. or more, for which ferrocement is especially suitable. Such tanks can be precast either in panels to be assembled on site, or they may be constructed entirely in situ. This technology is well developed and therefore provides an excellent means of introducing ferrocement techniques. Larger tanks could be either excavated pits lined with ferrocement or tanks built above ground level. Such tanks of more than 20 cubic feet capacity might also be developed for fish-breeding.

**Miscellaneous Structures.** The group considered sink and sanitary items and it was decided that ordinary factory produced precast concrete was likely to be more economical. For gutter units and other sub-structures, ferrocement has a clear advantage due to its toughness when subjected to frequent impact force.

Other applications suggested that merit trial and investigation are:

1. Ferrocement surfacing for soil-cement based country roads. The main advantage is that repairs may be easily carried out in the event of a crack of the sub-base. It would only require someone to chip away the broken concrete, excavate where necessary and then cast some concrete in the hole and restore the mesh. With regular inspection this should keep such a road in good condition.
2. Tube well-casings and screens which need to withstand compression and tension and have some clamping strength.
3. Septic tanks and caissons tanks in which methane (biogas) is generated from animal and vegetable wastes.

## Housing

Ferrocement is an excellent material for use in house construction. Its major role in Asia and the Pacific Basin will probably be in low- and middle-income housing.

Here ferrocement's main advantage is its longevity, and it is a versatile material that can be used to construct many parts of the house. A ferrocement shell roof is a good structure because it is water tight. It does not corrode readily, and it can span long distances and thus reduce the need for costly supports. Ferrocement can also be used around the home to construct septic and water tanks, staircases, floors, sinks, baths, etc.

But ferrocement has limitations too. It is a thin material that is not good for load-bearing walls, and the best house designs will use it in conjunction with reinforced concrete, brick, wood, etc.

In these times when the prices and availability of many raw materials are changing dramatically, it is difficult to predict the future competitiveness of ferrocement. Supplies of cement and wire mesh vary widely in the Asian-Pacific region; careful market analyses must be conducted before ferrocement construction activities are undertaken.

An attempt has been made in Papua New Guinea to introduce ferrocement for low-cost houses. Figure 9 shows a ferrocement roof panel being tested in New Zealand for eventual use in Papua New Guinea.

## Recommendation 1: An Information Service

All members of the workshop mentioned the need for an information service, including a bulletin that would keep interested members informed about ferrocement development.

Most members of the group also expressed the desire to have this information service established on a world wide basis rather than restricted to Asia. Attention was drawn to the New Zealand Ferrocement Marine Association, which at present has about 500 members, half of them from countries other than New Zealand. This Association publishes a bimonthly bulletin that has been highly successful in spreading unbiased information regarding ongoing activities in the ferrocement construction field. It is, however, established on a volunteer basis and needs further funding if it is to expand further. It is strongly recommended that a future information service cooperate with this highly competent Association. The group also felt that the main emphasis should be put on practical applications, in order to attempt to bridge the gap that now exists between research and actual construction.

### **Recommendation 2: Training Facilities**

Apart from the training of naval architects in Asia, the need for training was most urgent at the work-supervisor level. The training of ferrocement construction supervisors could be done through special courses conducted by existing national training institutions. The spread of the technology would be best achieved through practical demonstrations similar to the one given at AIT by the New Zealand firm showing the construction of water tanks.

### **Recommendation 3: Studying the Use of Ferrocement in the Peoples' Republic of China**

Since China remains the only country where ferrocement boat construction has been applied on a large scale, it would be worthwhile to make a detailed study of the industry there. Although, as previously mentioned, one should be cautious of copying the same type of boat used in other countries, a study of the actual method of introducing ferrocement on a large scale for river and canal transport, of the establishment of construction "factories" and of the acceptance of the ferrocement boats by people accustomed to wooden boats, might provide valuable information for other Asian countries with similar needs.

### **Recommendation 4: General Research**

Research is needed to solve two practical problems at present encountered in ferrocement construction:

#### **1. Development of a simple machine for the handweaving of steel mesh.**

In most countries in Asia, steel mesh represents about 78% of the total cost of materials used in a ferrocement structure. Woven mesh produced from wire by utilizing a simple handweaving machine might well mean a substantial reduction in the cost of materials and also make the mesh more readily available. The handwoven mesh will have superior strength compared with the presently used galvanized hexagonal mesh. The best ratio of wire diameter to mesh size should be determined through practical construction trials.

#### **2. Application of plaster to ensure void-free concrete**

The most common deficiency encountered in ferrocement boats is voids in the concrete leading to water seepage and rusting of reinforcement. Even with the two-stage plastering methods commonly used in New Zealand, this can happen due to the difficulty of assuring penetration of mortar through the multiple layers of rods and mesh. There is a need for a simple robust hand-held vibrator to ensure compac-

tion. At present an electric orbital sander is often converted to a vibrator by adding a plate, but it is questionable whether this tool developed for a different purpose represents the ultimate answer for ferrocement construction. Orbital sanders are rather vulnerable and usually do not last very long. An ideal vibrator possibly already exists on the market, but it is not commonly known among ferrocement boatbuilders.

### **Recommendation 5: Boatbuilding Research**

#### **1. Boat designs for Asia**

There is a need to develop **designs** for ferrocement boats suitable for Asian countries. Caution must be exercised in utilizing designs developed for one area indiscriminately for another area. Although this might successfully be done, the particular requirements should be studied in each case to ensure that the introduced design will correspond to what the market requires. Attention is drawn to the present service already provided by FAO for designs of fishing vessels and by UNIDO for the design of transport boats. Assistance from FAO or UNIDO can be requested through individual governments. Both FAO and UNIDO are reluctant to release drawings without an initial feasibility study and assurance that know-how in building ferrocement boats is available.

The best solution to the problem of providing suitable design is the training of naval architects in Asia to tackle the design of ferrocement boats. This can be done through a short-term regional training course, of say three months, similar to the one on fishing boat design organized by FAO.

#### **2. Scantlings Rules**

There is a need for rational **scantlings rules** for ferrocement boats. Attention was drawn to the "Tentative rules for construction and classification of ferrocement vessels" prepared by Det Norske Veritas, which are the most detailed rules on scantlings for ferrocement boats yet published.

TABLE 1  
FERROCEMENT AND ITS COMPETITION

Structure	Alternative
I Food storage silo	<ol style="list-style-type: none"> <li>1. Ferrocement containers</li> <li>2. masonry containers lined with cement mortar or plastic sheeting</li> <li>3. Ceramic tile containers</li> <li>4. Ceramic vessels</li> <li>5. Treated or untreated wood</li> <li>6. Aluminum or other metal sheet or foil lined containers</li> <li>7. Woven bamboo mesh plastered with mud.</li> </ol>
II Roofing	<ol style="list-style-type: none"> <li>1. Ferrocement tile or sheets</li> <li>2. Thatch</li> <li>3. Ceramic tile</li> <li>4. Concrete tile</li> <li>5. Galvanized iron sheet</li> <li>6. Aluminum sheet</li> </ol>
III Boats	<ol style="list-style-type: none"> <li>1. Ferrocement</li> <li>2. Wood</li> <li>3. Steel</li> <li>4. Fiberglass Reinforced Plastic</li> </ol>

**TABLE 2**  
**FERROCEMENT BOATS BUILT IN ASIAN/PACIFIC REGION**

Country	No. of Boats Built	Size of Boats	Type of Boat	No. of Ferroce-ment Boat Building Yards
Bangladesh	3	10 - 14m	Transport/fishing	1
China	2,000 (estimate)	12 - 15m	Transport	30 (estimate)
Hong Kong	4	15 - 27m	Fishing	
India	6	5 - 11m	Fishing	1
Indonesia				
Japan	10 (estimate)			
Korea	11	10 - 25m	Fishing	1
Malaysia	1			1
Pakistan	2			
Philippines	2			
Singapore	3		Transport/pleasure	
Sri Lanka	10	7 - 12m	Fishing	1
Thailand	30	5 - 24m	Pleasure, fishing transport	2
Vietnam North	unknown			
Vietnam South	50	7 - 20m	Transport	unknown
Australia				
Fiji	11	10 - 15m	Transport/fishing	1
New Zealand	500 (estimate)	8 - 20m	Pleasure, fishing tug boat	
Solomon Islands	3		Fishing	
Western Samoa	1	15m	Fishing	

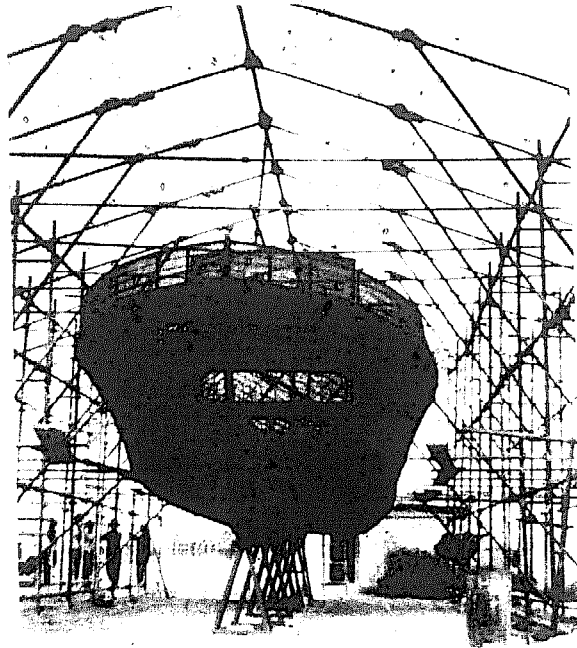


Figure 1: Ferrocement patrol boat under construction in Iran

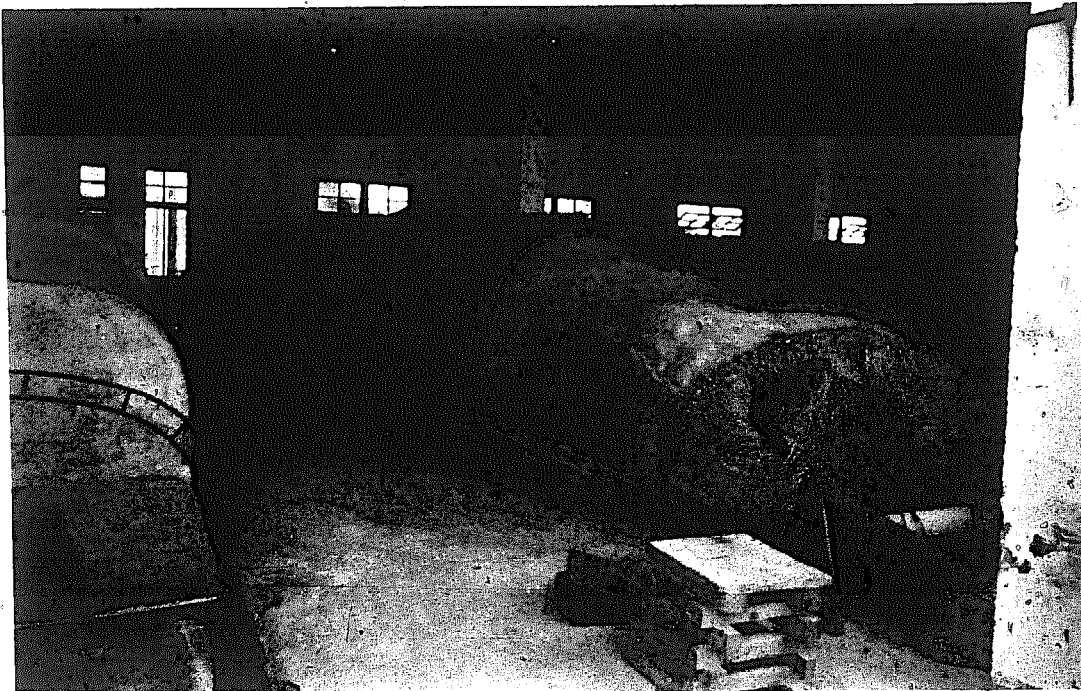


Figure 2: Ferrocement sampans in the Peoples Republic of China



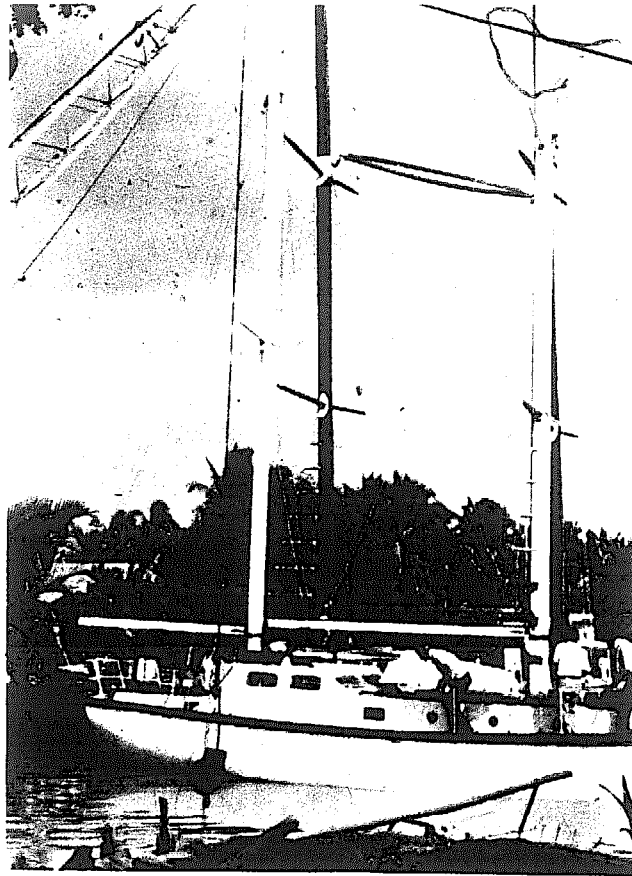


Figure 3: Ferrocement fishing boat in Thailand

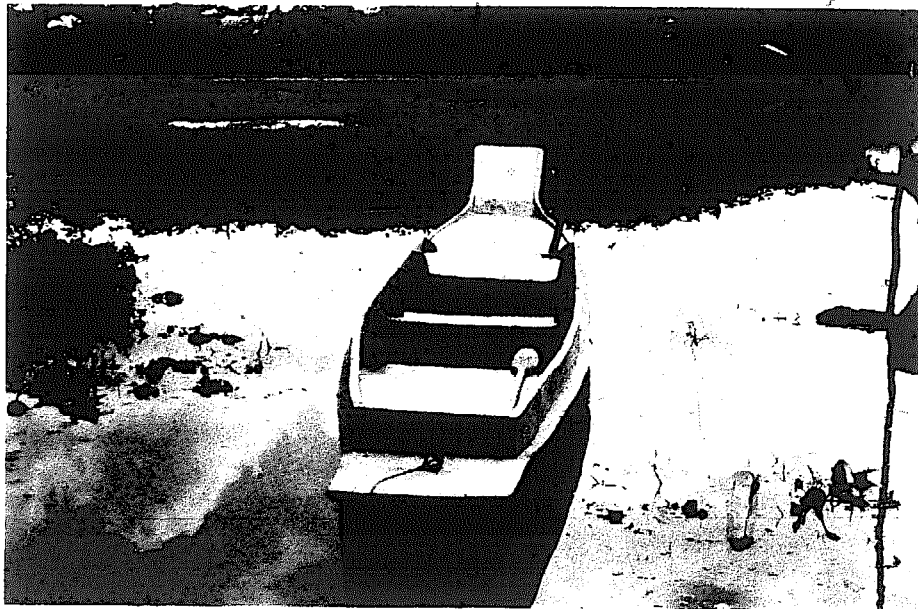


Figure 4: A Thai sampan in ferrocement. This small boat is strictly not ferrocement since the reinforcement is made of bamboo



Figure 5: Villagers in Fiji building their ferrocement fishing boat

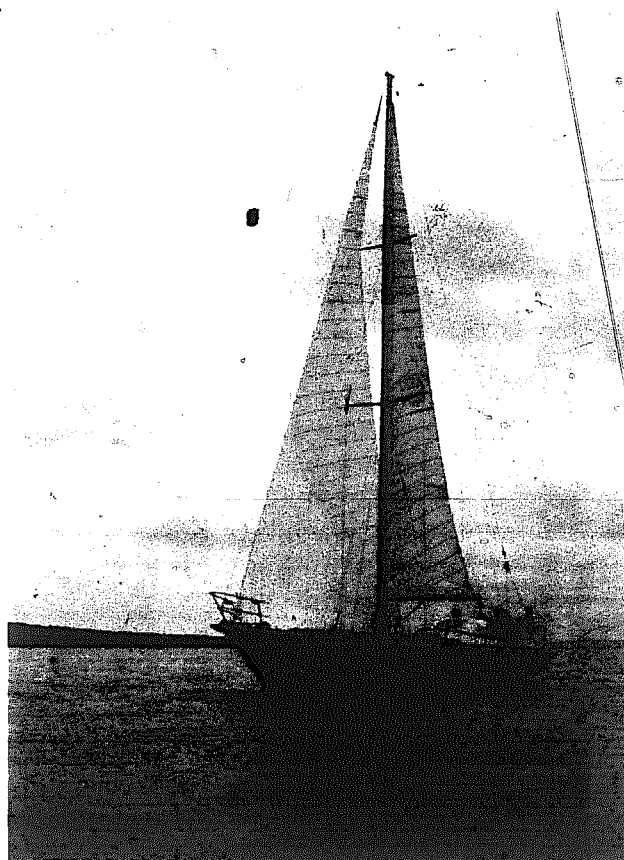


Figure 6: Ferrocement Yacht in New Zealand

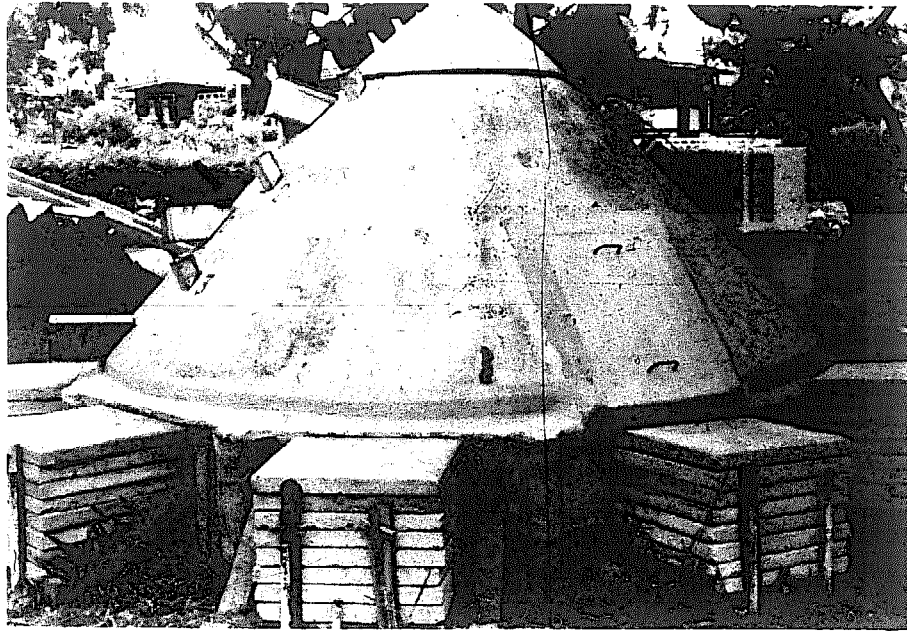


Figure 7: Rice bin made of unreinforced mortar in Thailand

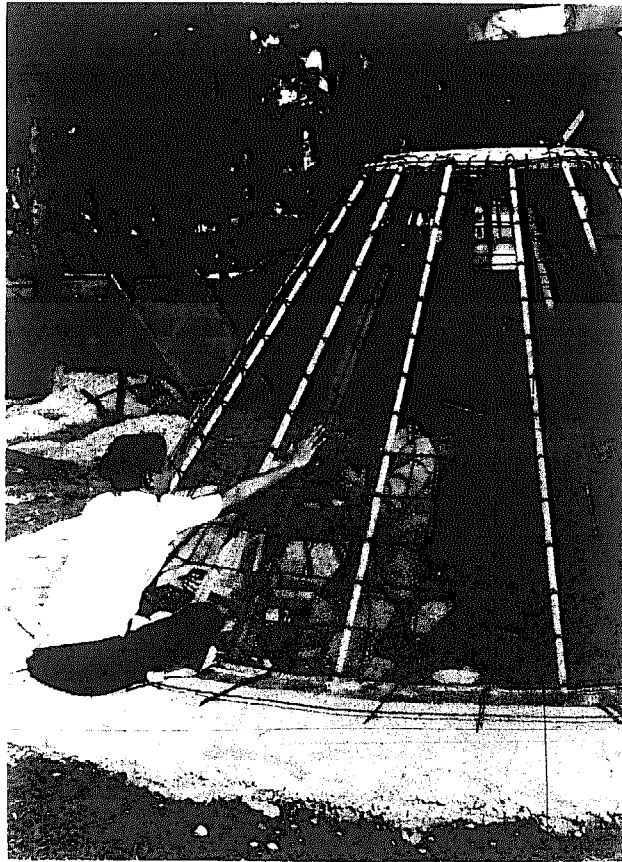


Figure 8: Reinforcement of the "Thailo", a ferrocement rice bin developed in Thailand

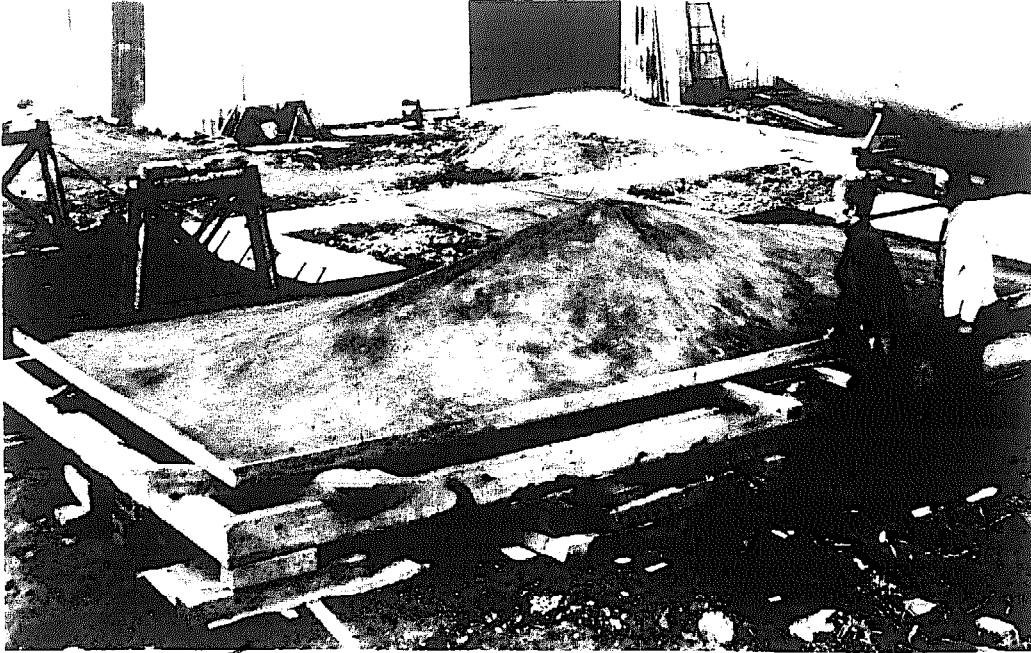


Figure 9: Prefabricated ferrocement roof panel used in Papua New Guinea

## APPENDIX A

## WORKSHOP PARTICIPANTS

## BANGLADESH

Mr. S.A.F. Rahman  
USAID American Embassy  
Dacca, Bangladesh

Dr. H.C. Visvesvaraya  
Director  
Cement Research Institute of India  
M-10 South Extension II  
Ring Road, New Delhi  
India

## CANADA

Dr. Gordon W. Bigg  
Ferrocem International Co., Ltd.  
1105 Normandy Cr.  
Ottawa K2E 5A3  
Ontario, Canada

## INDONESIA

Dr. Ir. Ariono Abdulkadir  
Consultant  
Bureau for the Promotion of Rice  
Marketing Facilities  
National Logistic Agency (BULOG)  
Indonesia

## FIJI

Mr. A. Sannergren  
United Nations Industrial  
Development Organization (UNIDO)  
Shipyard Manager  
Government Shipyard, Fiji

## KENYA

Dr. R. Bernard L. Smith  
Department of Civil Engineering  
University of Nairobi  
Nairobi, Kenya

## INDIA

Dr. M.S. Iyengar  
Managing Director  
Dr. M.S. Iyengar & Associates (P) Ltd.  
D II/4, N.P.L. Quarters  
Dr. K.S. Krishnan Road  
New Delhi - 110060  
India

## REPUBLIC OF KOREA

Dr. Sung Do Jang  
Korea Institute of Science and Technology  
P.O. Box 131  
Cheong Ryang, Seoul  
South Korea

Mr. T. Kanakasabapathy  
General Manager  
Ferro Cement Research Project  
Marina, Madras - 600 005  
India

Dr. H.C. Kim  
Korea Institute of Science and Technology  
P.O. Box 131  
Cheong Ryang, Seoul  
South Korea

Mr. J.S. Sharma  
Head, Building and Construction Division  
Central Building Research Institute  
Roorkee (U.P.)  
India

## MALAYSIA

Mr. Robert A. Bridge  
c/o Wakil Pos, Kg. Rusila  
Kuala Trengganu, Malaysia

Mr. Sim-Chin Chong  
Public Works Department  
Jalan Maxwell  
Kuala Lumpur, Malaysia

Mr. A.N.S. Kulasinghe  
Managing Director  
Seacraft Sdn. Berhad  
10B Jalan Madge  
Kuala Lumpur, Malaysia

#### NEW ZEALAND

Mr. Chester A. Treanor  
c/o Firths Industries  
Terapa  
Hamilton, New Zealand

#### PAKISTAN

Dr. S.M. Qureshi  
Member, Pakistan Science Foundation  
Post Box 1121  
435, F-6/3 Islamabad  
Pakistan

#### PHILIPPINES

Dr. Amir U. Khan  
Head, Agricultural Engineering Department  
The International Rice Research Institute  
Los Banos, Laguna  
Philippines

Father Emile Laquerre  
c/o Bishop's House  
Jolo, Sulu  
Philippines

#### SINGAPORE

Dr. P. Paramasivam  
Department of Civil Engineering  
University of Singapore  
Prince Edward Road  
Singapore

#### SRI LANKA

Dr. B.M.A. Balasooriya  
Design Office  
State Engineering Corp. of Sri Lanka  
No. 120 W.A.D. Ramanayaka Mawatha  
Colombo 2  
Sri Lanka

#### THAILAND

Dr. Pakorn Adulbhan  
Division of Industrial Engineering  
and Management  
Asian Institute of Technology  
P.O. Box 2754, Bangkok, Thailand

Mr. Nicanor C. Austriaco  
Division of Structural Engineering  
and Materials  
Asian Institute of Technology  
P.O. Box 2754, Bangkok, Thailand

Cdr. Viroth Chomchuenchit  
Staff Design Engineer  
Royal Thai Navy Shipyard  
Arun Amarin Road, Bangkok, Thailand

Dr. P.A. Cowell  
Division of Community and Regional  
Development  
Asian Institute of Technology  
P.O. Box 2754, Bangkok, Thailand

Dr. Tongchat Hongladaromp  
Division of Structural Engineering  
and Materials  
Asian Institute of Technology  
P.O. Box 2754, Bangkok, Thailand

Dr. Vithool Jerkjirm  
Division of Structural Engineering  
and Materials  
Asian Institute of Technology  
P.O. Box 2754, Bangkok, Thailand

Dr. Smith Kampempool  
 Director  
 National Building Research and  
 Development Center  
 Applied Scientific Research Corporation  
 of Thailand  
 Phaholyothin Road, Bangkok, Thailand

Dr. Pisidhi Karasudhi  
 Division of Structural Engineering  
 and Materials  
 Asian Institute of Technology  
 P.O. Box 2754, Bangkok, Thailand

M.R. Supanivat Kasemsant  
 Assistant Head, Applied Research Dept.  
 The Siam Cement Co., Ltd.  
 P.O. Box 572, Bangkok, Thailand

Mr. C.Y. Lee  
 FAO Regional Office  
 (FAO Regional Marketing, Credit and  
 Cooperated Officer)  
 Phra Atit Road, Bangkok, Thailand

Prof. S.L. Lee  
 Division of Structural Engineering  
 and Materials  
 Asian Institute of Technology  
 P.O. Box 2754, Bangkok, Thailand

Dr. S. Morino  
 Division of Structural Engineering  
 and Materials  
 Asian Institute of Technology  
 P.O. Box 2754, Bangkok, Thailand

Vice Admiral Tiem Makarananda  
 Naval Shipyard Director  
 Royal Thai Navy Shipyard  
 Arun Amarin Road, Bangkok, Thailand

Mr. Siengthong Natalaya  
 Experimental Officer  
 Applied Scientific Research Corporation  
 of Thailand  
 196 Phaholyothin Road  
 Bangkhen, Bangkok 9, Thailand

Mr. Hon-Kwong Ng  
 Division of Structural Engineering  
 and Materials  
 Asian Institute of Technology  
 P.O. Box 2754, Bangkok, Thailand

Dr. Pichai Nimityongkul  
 Division of Structural Engineering  
 and Materials  
 Asian Institute of Technology  
 P.O. Box 2754, Bangkok, Thailand

Mr. Dusit Nontanakorn  
 Market Development & Products Division  
 The Construction Material Marketing  
 Company Limited  
 P.O. Box 1770, Bangkok, Thailand

Mr. Bunchu Pakotiprapha  
 Division of Structural Engineering  
 and Materials  
 Asian Institute of Technology  
 P.O. Box 2754, Bangkok, Thailand

Dr. Ricardo P. Pama  
 Division of Structural Engineering  
 and Materials  
 Asian Institute of Technology  
 P.O. Box 2754, Bangkok, Thailand

Mr. Kee Seung Park  
 Regional Water Development and  
 Management Officer  
 FAO Regional Office  
 Phra Atit Road, Bangkok 2, Thailand

Mr. Sampao Pattraketwit  
 Experimental Officer  
 Agricultural Products Research Institute  
 Applied Scientific Research Corporation  
 of Thailand  
 196 Phaholyothin Road  
 Bangkhen, Bangkok, Thailand

Mr. Godfrey Payne  
 Information Officer  
 Asian Institute of Technology  
 P.O. Box 2754, Bangkok, Thailand

Mr. Opas Phromratanapongse  
 Head, Product Development Department  
 Applied Research and Development Division  
 The Siam Cement Co., Ltd.  
 P.O. Box 572, Bangkok, Thailand

Mr. Sayom Ratnavichit  
 Chief  
 Social Studies and Planning Division  
 Department of Public Welfare  
 Krung Kasem Road  
 Bangkok, Thailand

Capt. Pongsak Sarakashetrin  
 Technician Officer  
 Royal Thai Navy Shipyard  
 Arun Amarin Road, Bangkok, Thailand

Mr. David Srimahachota  
 Division of Structural Engineering  
 and Materials  
 Asian Institute of Technology  
 P.O. Box 2754, Bangkok, Thailand

Prof. J.E. Stepanek  
 Division of Industrial Engineering  
 and Management  
 Asian Institute of Technology  
 P.O. Box 2754, Bangkok, Thailand

Mr. Robert R. Stevens  
 General Manager  
 Colorado Eastern  
 G.P.O. Box 783, Bangkok, Thailand

#### UNITED KINGDOM

Mr. S.B. Watt  
 Project Engineer  
 Intermediate Technology Development Group  
 Parnell House  
 25, Wilton Road  
 London SW1  
 England, U.K.

#### U. S. A.

Dr. W.F. Chang  
 Department of Civil Engineering  
 University of Miami  
 Coral Gables, Florida 33124  
 U.S.A.

Mr. Henry J. Larsen, Jr.  
 Larsen and Ludwig Engineers and Architects  
 1102 Century Building  
 Pittsburgh, Pa 15222  
 U.S.A.

Dr. W.H. Littlewood  
 Associate Director  
 Office of Science and Technology (TA/OST)  
 A.I.D., Department of State  
 Washington, D.C. 20523  
 U.S.A.

Dr. James Romualdi  
 Director, Transportation Research Institute  
 Carnegie-Mellon University  
 Pittsburgh, Pennsylvania 15213  
 U.S.A.

Dr. Noel D. Vietmeyer  
 National Academy of Sciences  
 National Research Council  
 2101 Constitution Avenue  
 Washington, D.C. 20418  
 U.S.A.

#### WESTERN SAMOA

Mr. Øyvind Gulbrandsen  
 F.A.O. Fisheries Adviser  
 P.O. Box 206  
 Apia  
 Western Samoa



## APPENDIX B

### DESIGN PHILOSOPHY FOR FERROCEMENT

by

R.B.L. Smith

#### Introduction

Although ferrocement is well established as a material for boat building, in its wider application, particularly for terrestrial purposes, it may be regarded as a new material of construction. This has led to many suggestions for its development and also to an interest in its material properties, which have until recently been treated empirically for the special requirements of marine construction. Research has been in progress for over a decade on the properties of mortars reinforced with randomly distributed wires which would be expected to be similar to those of ferrocement. The rational design of reinforced and prestressed concrete is based on the examination of appropriate limit states in relation to the structure, and it is desirable to consider what limit states should be applied to structures designed in ferrocement. This in turn raises the question as to what types of structure realise the inherent advantages of ferrocement.

#### Characteristics of ferrocement

Ferrocement has been described as a densely reinforced mortar formed into a thin shell, which behaves as a composite material, whose properties depend on the combination of steel (in the form of fine steel wire mesh) and dense, high strength mortar. Although in normal reinforced concrete the use of small diameter steel rods is used to improve the ability of concrete to resist tension due to shear forces, and to control cracking due to shrinkage, the reinforcement is placed to resist tensile forces directly in regions where the concrete has exceeded its tensile strain capacity. In order to utilise economically the tensile strength of the steel under these circumstances, the maximum strain attains values of 0.15 to 0.2% at its limit of useful behaviour, which is of the order of ten times the tensile strain capacity of the concrete. Hence the fundamental assumption in reinforced concrete design is that concrete is assumed to resist no part of the flexural tensile forces.

However, one of the objects of investigation of mortar reinforced randomly with fine wires, is to improve the tensile strength compared with the plain material. In ferrocement the wires are not randomly distributed in three dimensions, having layers of mesh in the plane of the shell, but from the point of view of in-plane tensile forces, such reinforcement may be considered effectively random, and similar results are obtained. This work has demonstrated that the tensile cracking stress increases proportionately with the amount of steel per unit volume of composite up to a practical limit imposed by the maximum steel concentration for which the mortar may be compacted. An increase of cracking stress of three to four times may be achieved at maximum steel density but this increase would not be of value in combination with conventional reinforcement as discussed above (which would require a much greater strain capacity increase) at the limit state of collapse. For prismatic members such as beams and columns, and for plane slabs, the increase in tensile strength does not lead to an economical alternative to reinforced concrete on the basis of homogeneous rather than transformed section design. However, for structures such as reinforced con-

crete water tanks, where the appropriate limit state is the tensile cracking of the concrete, such a material could be advantageous.

The characteristic in which ferrocement differs fundamentally from randomly reinforced concrete is constructional, due to the use of mesh, the several layers of which enable the mortar to be placed without any other form of mould. It is also different in this respect from reinforced concrete due to the close spacing of the wires as compared with conventional reinforcement. This characteristic is of outstanding importance because it enables the economical construction of thin shells of any geometry to be achieved.

### **Advantages of shell structures**

It is significant that the major field of application of ferrocement at present is boat construction, in which a doubly curving shell structure is determined by the nature of its function and loading. Curved shells have long been the logical choice of shape for vessels of all types marine, pressure and storage, such as boats, boilers, cooking pots and granaries. Only in buildings have the human requirements of flat floor slabs and plane walls led to linear structural elements. However, apart from pottery and traditional sheet metal work, the formation of curved shells is an expensive, technologically advanced and at times hazardous operation, although the introduction of ferrocement may significantly change this.

Linear elements are generally used only for quite short spans, such as bridge decks and cross girders, roof slabs and beams, which are integrated into a larger curved structure, arch or cable for very long spans, or domes to cover large spaces. The extra cost of curved formwork for reinforced concrete requires an economic balance to be struck between the structural advantages of curved structures and the constructional simplicity of linear elements. It is also suggested that designers have been restricted by the process whereby a structure has first to be drawn on a drawing board, which tends to restrict the imagination; then working drawings have to be prepared to instruct the workman, and these are more difficult to draw and to understand and are less amenable to standardised conventions for structures which cannot be represented as a set of intersecting orthogonal planes. Using ferrocement this still applies, since the designer's conception must be communicated to the builder. This link must have been as necessary for the creation of the octagonal lantern in Ely Cathedral as it is for the construction of a ferrocement boat, in which it is provided by a close association between designer and builder, who are not divorced into separate compartments as in so much present day structural engineering. Whilst close collaboration of designer and builder is highly desirable, it is necessary also to be able to communicate without personal contact (as for example when a design is transmitted to a remote location), and attention must be paid not only to the clear and simple presentation of drawings, but to the equally important matters of details such as construction joints and the control of mix and curing.

A further aspect of the relative merits of curved shell and linear structures is the paradox, well known to every structural research worker who has tried to carry out accurate tests, that in some respects linear structures are more complicated than curved ones. This arises from the practical impossibility of achieving the idealised supports assumed in theory and from the uncertainty of the restraints imposed by real supports. The majority of practical structures do not even attempt to eliminate such restraints and this may result in stresses exceeding those assumed in design due to the imposed loads, which are caused by material shrinkage and thermal strains. In comparison, a shell structure can accommodate itself to such strains by a slight change of geometry, with consequent reduction of such undesirable stresses.

## Design of Ferrocement Structures

The improvement of the effective tensile strength of mortar, as measured by the cracking or ultimate loads, due to the introduction of steel fibres or wire mesh, is significantly of the order of up to 3 or 4 times. But if we consider that the tensile strength of steel is between 100 and 1,000 times greater than mortar, and that of timber and glass over 10 times greater, it is evident that even the most densely reinforced mortar does not achieve the range of tensile strength of these other materials or of prestressed concrete, which latter can attain an effective tensile strength exceeding its compressive strength, and is therefore directly comparable to timber or glass.

It seems reasonable therefore to suggest that the main purposes of the wire mesh reinforcement in ferrocement are:

1. to increase the resistance to impact and to prevent complete collapse of the structure if it is cracked by the load, i.e., to produce some effective ductility and to localise damage.

2. to provide a skeleton for the construction. For this purpose it has been found that two layers of mesh (chicken wire) are sufficient for the adherence of the mortar in a shell of 2 to 3 cm. thickness, provided that the overall skeleton is rigid.

From this it follows that the construction of curved shells subjected to distributed loading from liquid, granular material, wind and self weight, as for example, boats, water tanks, grain stores and roof structures, are ideal applications of ferrocement. The presently used method of application of the mortar, by hand, and the problems of the rigidity of the mesh skeleton, of the continuity of construction and of the control of compaction, would appear to limit the size of structure suitable for ferrocement and point to the desirability of new techniques of application employing a greater degree of mechanisation.

For such structures in which the loading permits some freedom of geometry of the structure, advantage can be taken of the membrane hypothesis which discounts the effects of bending moment. For many applications the impermeability of the material is the most important consideration. Provided the mortar is properly compacted and cured, the permeability depends very critically on water-cement ratio, being very low (almost impermeable) for less than 0.4 water-cement ratio, but increasing rapidly above that value. Above this basic material requirement it is necessary to ensure that the tensile stresses caused by the loading are within the limit of initial cracking, which therefore becomes the most significant limit state for design.

Structures for which impermeability is not essential could be designed for a limit state of collapse, taking into account the ultimate resistance of the cracked section as in reinforced concrete. This would depend entirely on the constructional advantages of ferrocement compared with reinforced concrete, and it is suggested that it is preferable to base the design of such structures also on a limit state of initial cracking.

Thus for all applications the cracking strength of the material is the property of major importance in relation both to the mortar mix, including the influence of water-reducing admixtures, and to the ratio of mesh reinforcement from the minimum required for construction purposes up to the maximum possible for compaction of mortar. It is necessary to define such a cracking load consistently. In reinforced and prestressed concrete codes permissible crack widths are specified, but this is not satisfactory for ferrocement since the tolerable widths of cracks are of the order of micro cracks. Consequently, the author is at present trying to relate the permeability of the material to the gradual application of tensile and flexural stresses, measuring also material strains and deflections in the same experiments with the intention to establish some information on the cracking strength of various mixes and reinforcement ratios.

## Conclusions

In order to take advantage of the hermetical properties of ferrocement as far as possible within the constraints imposed by the nature of the loading and the geometrical boundaries of the structure, designs should satisfy the membrane hypothesis for shells. This entails careful attention to the boundaries of the structure, i.e. joints and supports. This particularly applies to larger structures, but even for small structures, sharp changes of curvature should be detailed with caution.

While the non-requirement of a mould or other supporting framework during construction and the similarity of the mortaring technique to traditional craft methods of construction may suggest ferrocement as an example of "intermediate technology" to be applied by farmers and others to a great variety of construction, it should be borne in mind that it is a material capable of high quality performance, and apart from emergency operations, it is uneconomical to use it except to high standards of design and construction. For this kind of work, although a code of practice embodying limit states is hardly appropriate, it is none the less necessary to have values of good practice, especially because one cannot afford to waste money in such conditions. For such applications, strength is not of importance compared with freedom from cracking caused by shrinkage and thermal movements, since apart from its adverse effect on liquid retaining structures, cracking leads to the loss of durability of any type of structure, and it should be the object of ferrocement construction to have a long useful life compared with any alternatives.

One aspect of ferrocement which is important for boat building is the ease with which damage may be repaired. This same advantage may be useful in other applications subject to impact loads, and in particular as a surfacing to roads with a soil-cement base.

## APPENDIX C

## FERROCEMENT RESEARCH AND DEVELOPMENT IN TAMIL NADU, INDIA

by

T. Kanakasabapathy

India, with a coastline of 6,550 kms. and fishable marine area of over 259,000 Sq. kms., holds tremendous potentialities for the development of her fisheries. The marine catch of 1.1 million tons per year in India is negligible compared to the World total of over 60 million tons. The total availability of the catch around the Indian Coast is estimated to be around 14 million tons per annum.

The main reasons why fishermen are unable fully to exploit the catch potential are:

1. traditional non-mechanized methods still used by the fishermen;
2. wood as the craft material in most cases;
3. lack of improved boat design;
4. ever increasing cost of mechanized fishing boats and their subsequent maintenance in the absence of fishing harbours.

Out of the 10,000 mechanized fishing vessels in the country, only about twenty of the over 50 foot class are engaged in commercial fishing. The imperative need has therefore been felt for an intensive exploration of the waters around the India Coast. The only answer to the problem is to have more mechanized fishing vessels which could be mass-produced at a cost that would be within the means of the local fishermen. Ferrocement as a media for construction of fishing boats was thought of in 1970.

### Ferrocement

It was known what problems can be encountered when a new technology is introduced into a country and hence a very cautious beginning was made in 1970 by the Department of Fisheries in Tamil Nadu, Madras, India. There had been much discussion and work done under the heading of ferrocement in the developed countries from 1960. The valuable information on ferrocement boat building made available from New Zealand, Australia, Canada and by the FAO was accepted and on the basis of this information the first ferrocement boat was built in the country with workmen who were already experienced in wooden boat-building techniques.

### Ferrocement Boat-Building:

The need to find a replacement material for wood was urgent because of the ever increasing cost. This provided an opportunity to introduce ferrocement technology in the country. The theoretical and technical side of ferrocement construction is now known in many countries, so the author does not intend to dwell on this aspect, but will rather mention a few points where its application is necessary in a developing country such as India.

The construction of a ferrocement fishing vessel involved the procurement of a small quantity of the cheapest wood, steel in the form of mild steel rods and galvanized chicken

mesh, sand, water and cement. With the materials locally available, and with the local labor already well-versed in wooden boat building, the construction of the first 38 ft fishing boat was undertaken and the boat was completed and launched in 1972 at a cost of Rs. 115,000, or US\$15,400. This cost includes the engine, deck equipment, overheads, etc. Comparing ferrocement with other boat building materials, it was found that ferrocement boats were cheaper. On the success of this experiment, a project was established to propagate the potential benefits of the use of ferrocement in boat building. More boats are being built and this breakthrough was made in 1974. The project's work for the last four years has proved that:

- o Ferrocement is a potentially attractive alternate to wood in boat construction.
- o Ferrocement construction is as labor intensive as wooden boat building and so its introduction will not make labor engaged in wooden boat building redundant.
- o Labor skill required for making a ferrocement boat is relatively low when compared to wooden boat building.
- o Ferrocement boats cost less to construct compared to conventional types.
- o Ferrocement in India needs no component of foreign exchange.
- o Ferrocement is easy to repair and requires minimum maintenance.
- o Ferrocement will alleviate the chronic shortage of fishing vessels of all types.

The aim of the project was to create local interest and to prove the profitability of ferrocement boat construction in a developing country such as India. Figure C1 shows a boat built in the project.

#### Ferrocement boat for inland water

A 22 ft long ferrocement boat for use in rivers and reservoirs has been built. It was launched in the River Coovum in Madras city for trial purposes although it was built for use in the Bhavanisagar reservoir in Coimbatore, Madras. The performance of the ferrocement inland boat was acceptable and now inquiries are being received for similar small vessels. The actual cost of the boat is equivalent to that of a wooden design because of the various constructional changes made during the entire work. Extra labor was required for this first boat:

Materials	Rs. 3,692.75
Timber	Rs. 870.12
Labor (6724 manhours)	Rs. 8,338.25
	<u>Rs. 12,901.12*</u>

Figure C2 shows the 22 ft boat in the River Coovum.

---

\* 1 Rs. is approximately \$0.134

## Coracle

This is a common type of country craft made of split bamboo covered with buffalo skin, used by local people to cross rivers for fishing in rivers and reservoirs. An attempt was made to fabricate the same in ferrocement. This attracted much attention and now it is proposed to build a few more such craft for use in the Fisheries Department, Madras. The main intention is to popularize them among the local people. The actual cost of the coracle is:

Material	Rs.	323.41
Labor (270 manhours)	Rs.	<u>240.96</u>
	Rs.	564.37

Figures C3 and C4 show the coracle.

## Miscellaneous

Besides the above work, a round-bottom row boat of 15 ft and a flat-bottom row boat of 15 ft with provision for outboard motor have also been built and are undergoing trials in lakes. The latter is shown in Figure C5.

## Ferrocement in rural development

Although less publicized than many other parts of the world, India has also been a center of ferrocement activity. From the boat-building experience gained over the last four years, the material and expertise was adapted to other terrestrial applications, such as grain silos, vats for fish ensilage, water tanks, and Gobar gas cylinders. Below is a brief description of these structures together with their costs.

### Grain Silo

Experience in Thailand and Ethiopia had shown that ferrocement grain silos can be built on site very inexpensively. The basic design of the silo was a copy of the grain silo made in Thailand. The one built in Tamil Nadu was a shell type without webs or stiffeners. The base of the silo is saucer-shaped and built of 7mm. rods in the manner of a cobweb. The walls sloping inward are reinforced with 7 mm. rods and two layers of ½" hexagonal chicken mesh, each on both inside and outside. The mortar ratio was similar to that used in boat building. The top inlet was built-in with the shell structure itself, but its shape was modified to suit local conditions. The top cover was fabricated like the man-hole

covers found locally, which prevented the water getting in, but with a locking arrangement. A small slide type opening at the ground level was provided with locking facilities. This was the first silo built, and the actual cost was:

Materials	Rs.	669.42
Labor (669 manhours)	Rs.	<u>536.39</u>
	Rs.	1,205.81

Figures C6 and C7 show the grain silo designed and fabricated in the project.

#### Vat for fish ensilage.

The Indian Council of Agricultural Research, Fisheries Unit, at Madras is experimenting with various types of vats made out of various materials and wanted a vat made out of ferrocement also. A design was made, and one vat was constructed and handed over to the research station. It is being used and the results are awaited. The actual cost of the vat is as follows:

Materials	Rs.	38.26
Labor (113 manhours)	Rs.	<u>82.89</u>
	Rs.	121.15

Figure C8 shows the frame of the vat that was built.

#### Water tank

The ferrocement boat building project was using old diesel oil barrels for storing water for the purpose of curing ferrocement boats. The barrels often got rusted and needed regular painting. The workers joined together, made out a barrel type design and made a water tank to store water. They used welded mesh of 1" x 1" as the main reinforcement. Two layers each of 1/2" hexagonal wire mesh both inside and outside formed the entire skeleton. It was mortared in the same way as in ferrocement boat building. The actual cost is as follows:

Materials	Rs.	192.65
Labor (177 manhours)	Rs.	<u>71.05</u>
	Rs.	263.70

There is now a great demand for such tanks locally. Figures C9 and C10 show the water tank.



### Gobar gas cylinder

Though bio-gas plants have been known for several decades, their prominence in public discussions of the energy and fertilizer situation is a recent phenomenon. The main reason for the interest in this field today is the recent oil crisis, which compelled a desperate search for alternative sources of energy. The Gobar gas plants consist of two main parts: a digester or fermentation tank with an inlet into which cowdung is introduced in the form of liquid slurry, and a gas holder to collect the gas. The design was given by Khadi and Village Industries Commission. The design of the digester is to be built of masonry construction and the gas cylinder is to be made of mild steel sheets and angles. Many practical problems had to be faced by the field staff of the Khadi and Village Industries Commission. A 60 cu.ft./day plant cost Rs. 3000 — in February 1974. There are about 20 different sizes and capacities of Gobar gas plants, ranging from 60 cu.ft./day. (1.7 cubic meters/day) to 5000 cu.ft./day (42 cubic meters/day). It was reported that 8000 plants are in operation. Under the Fifth Five-Year Plan, 50,000 plants are to be set up. The shortage and cost of the mild steel sheet for making the Gobar gas cylinder was the main problem in promoting the scheme. So the Ferrocement Craft Research Project was approached for help. The design given by the Khadi and Village Industries Commission was accepted and construction details were worked out. A Gobar gas cylinder out of ferrocement was fabricated, based on the experience gained in making the water tank. Welded mesh of 2" x 2" of 12 gauge was used as reinforcement and two layers of ½" hexagonal mesh were used both inside and outside. Mortar was applied in the same way as in ferrocement boat building. The first Gobar gas cylinder built was tested by the field staff of Khadi and Village Industries Commission and they were entirely satisfied with its performance. The actual cost of the 60 cu.ft./day Gobar gas cylinder alone is as follows:

Material	Rs.	249.27
Labor (200 manhours)	Rs.	94.23
		<hr/>
	Rs.	343.50

Now the Ferrocement Craft Research Project is being requested to work out details of a ferrocement digester also, so that the entire Gobar gas plant can be prefabricated, taken to site and installed. On the request of the Khadi and Village Industries Board, ten 100 cu.ft./day and 250 cu.ft./day ferrocement Gobar gas cylinders were made with the help of the staff of the latter. This is because the ferrocement Gobar gas cylinder is cheaper today when compared to the gas cylinders made out of mild steel sheets and angle. It is also well-known that Gobar gas plants yield organic manure (1.5 — 2.0% nitrogen) in addition to bio-gas, which is an added attraction in the rural area.

Figure C11 shows the Gobar gas cylinder.

### Conclusion

The potential as regards fishing vessels, both for inland and ocean waters, is very large. Ferrocement as a material is becoming popular as the initial inertia of tradition, suspicion and prejudices of the fishermen are being overcome. There are a number of ways in which the introduction of ferrocement in India might proceed. However, there is a clear need for

the new material in several sectors of the economy and it is concluded that there is now no longer a need to sell the concept at the official level, because of the initial sound work done by the Government of Tamil Nadu in Madras, India.

#### References:

1. Nontanakorn, D., "Construction of a 32 meter Ferrocement barge and selected applications of F.C. in Thailand", Seminar on the Design and Construction of Ferrocement Fishing Vessels, Wellington, New Zealand, Oct. 1972.
2. Tayab, M.A.K., "The Cost of Ferrocement Boat Construction in India", Seminar on the Design and Construction of Ferrocement Fishing Vessels, Wellington, New Zealand, Oct. 1972.
3. Prasad, C.R., Krishna Prasad, K. and Reddy, A.K.N., "Bio-gas Plants Prospects, Problems and Tasks", Indian Institute of Science, Bangalore, India.
4. "Ferrocement: Application in Developing Countries", National Academy of Sciences, Washington, D.C., Feb. 1973.

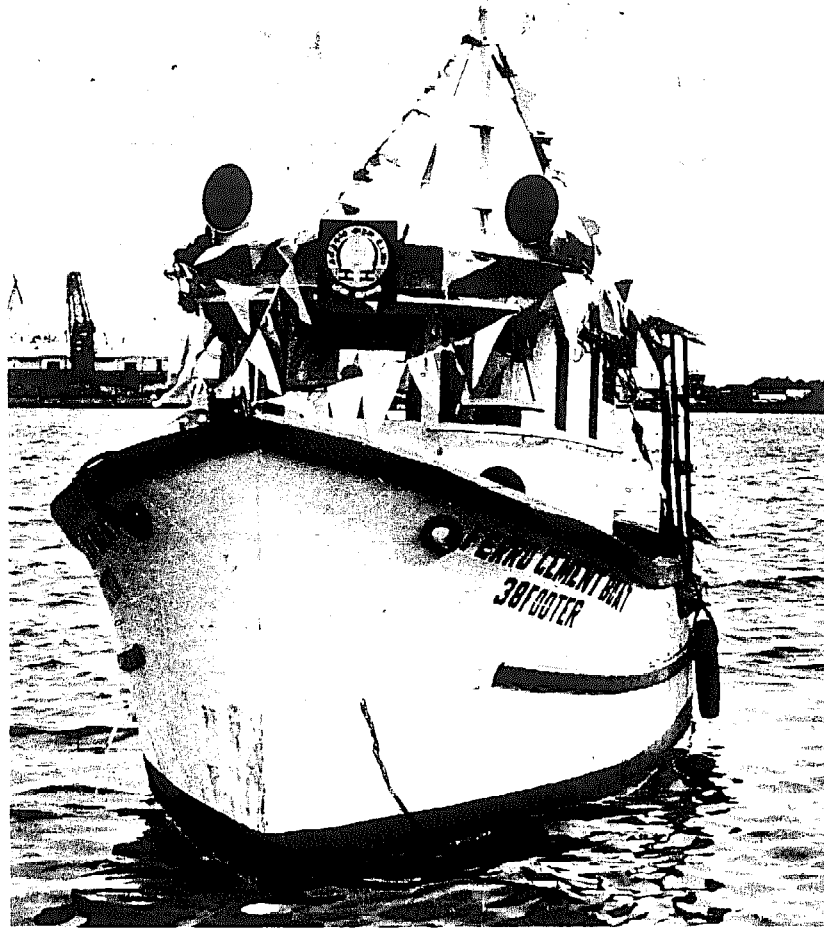


Figure C1: A typical ferrocement boat built in the project

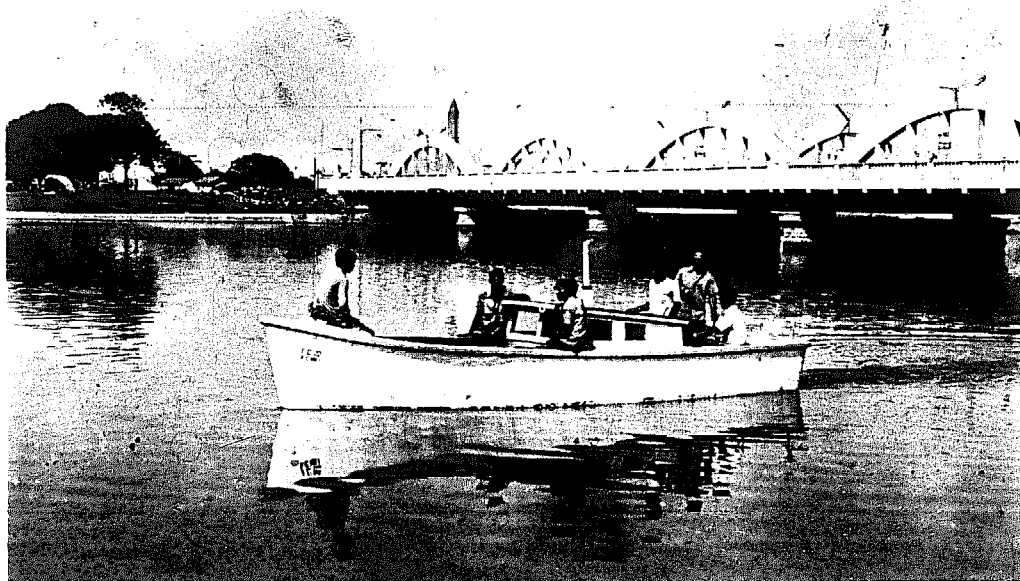


Figure C2: Ferrocement boat for inland waters

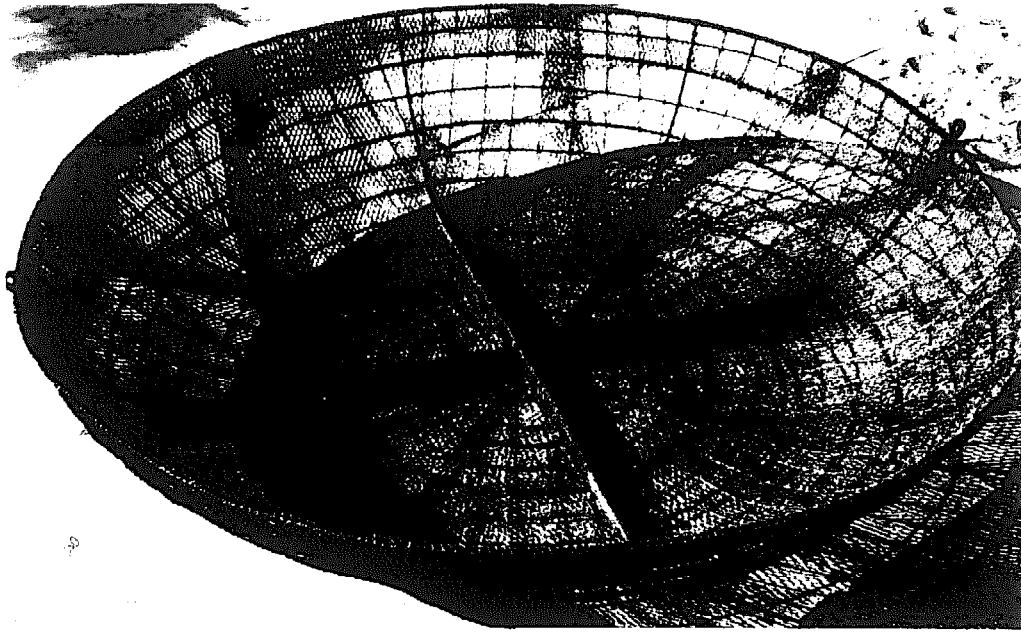


Figure C3: The wire frame for a ferrocement coracle



Figure C4: Finished coracle in use

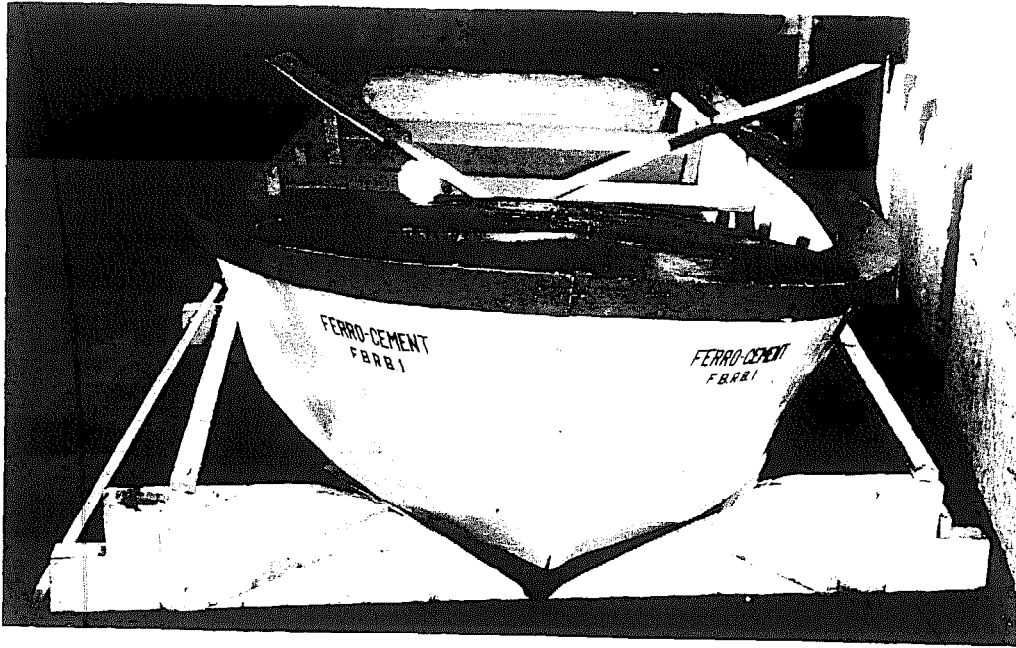


Figure C5: A ferrocement row boat

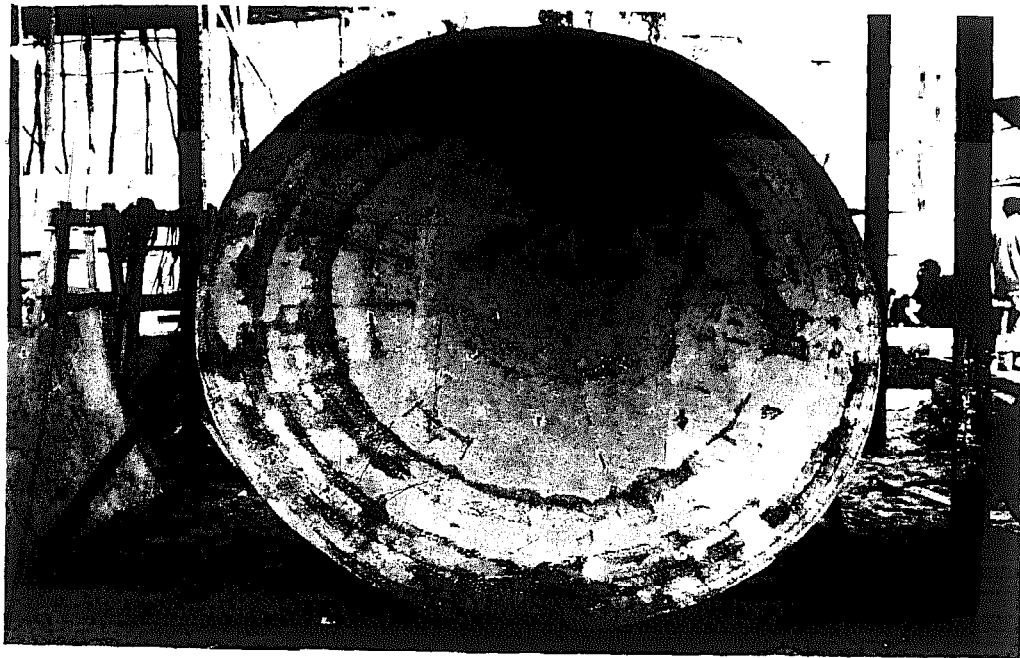


Figure C6: Base of ferrocement grain silo

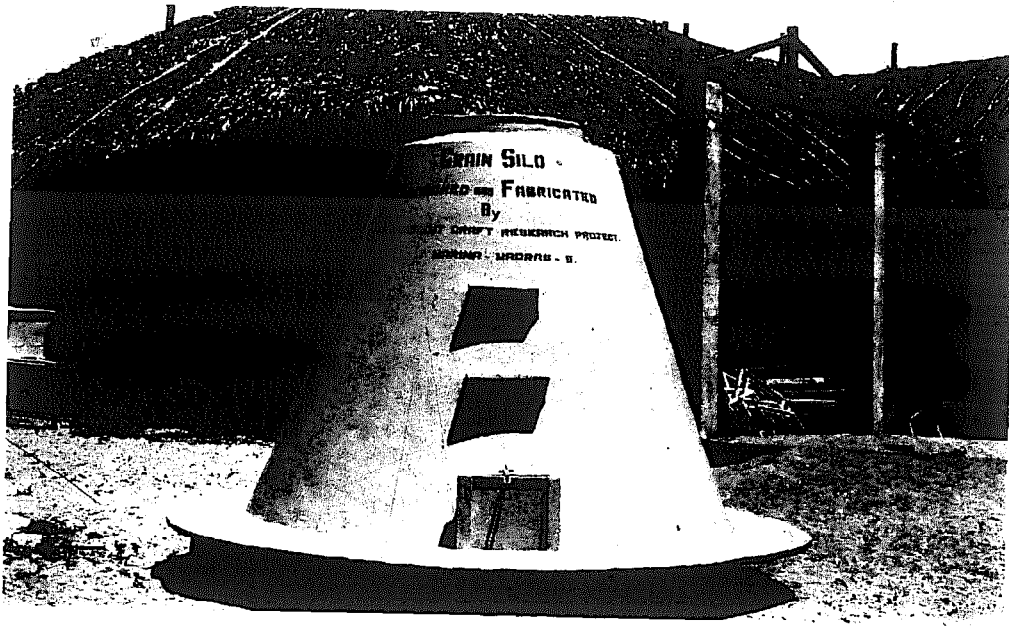


Figure C7: Ferrocement grain silo

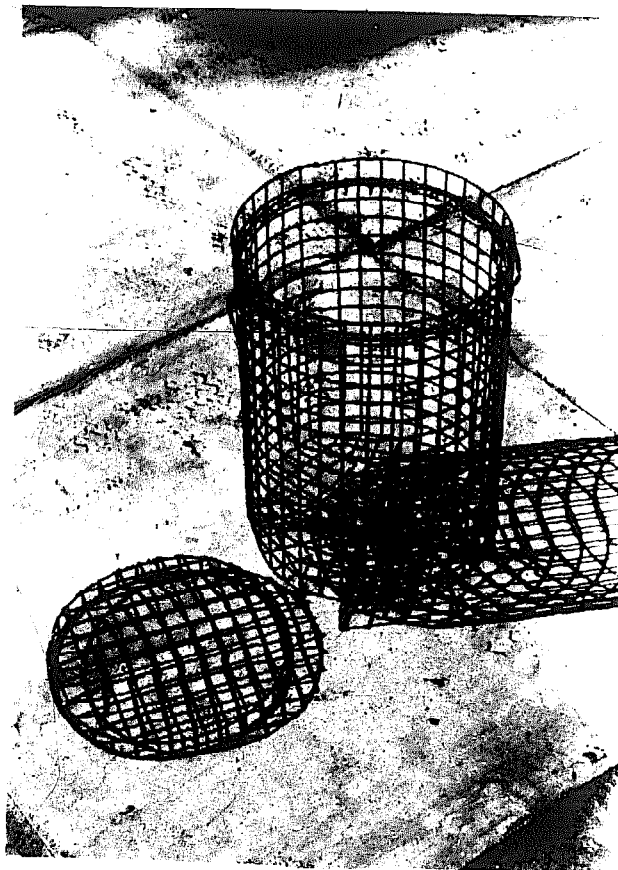


Figure C8: Frame of ferrocement vat for fish ensilage

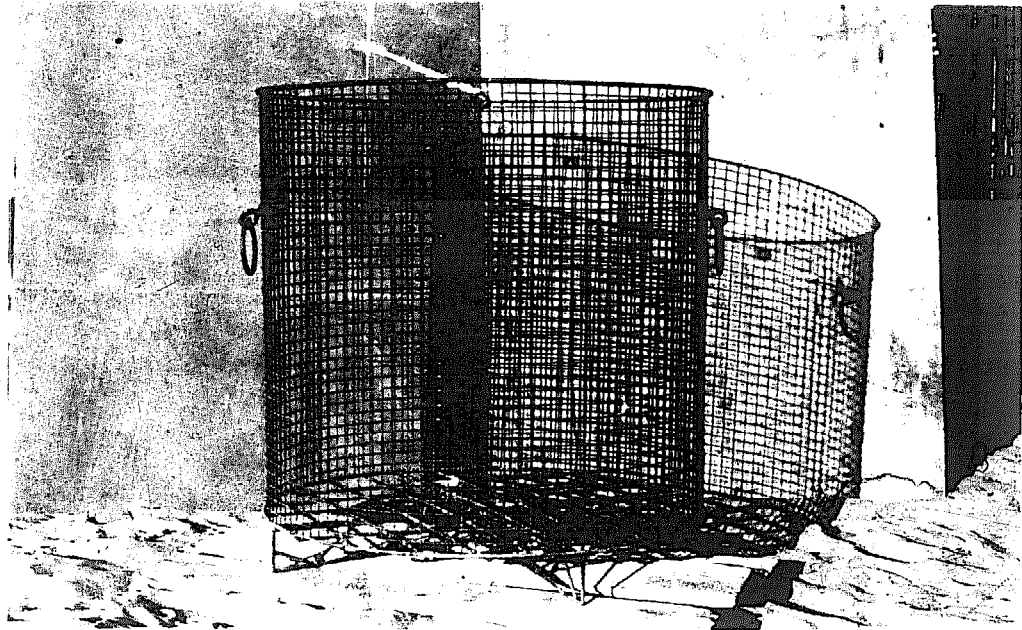


Figure C9: Frame for ferrocement water tank

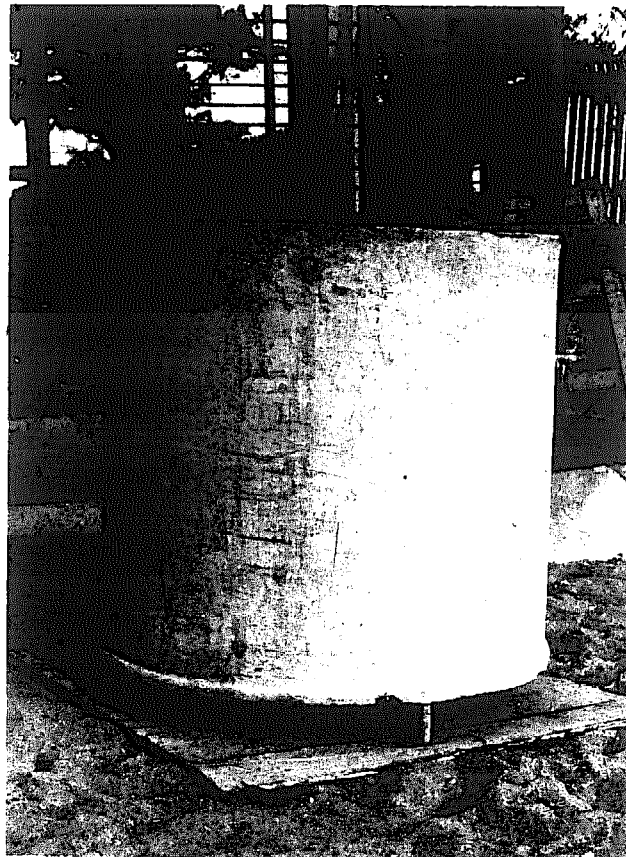


Figure C10: Ferrocement water tank

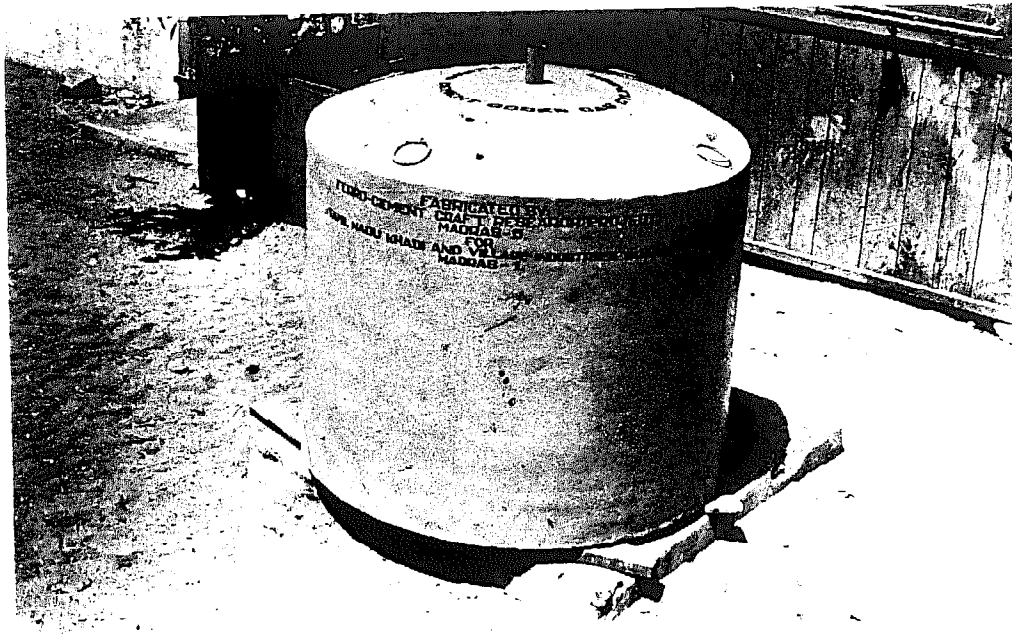


Figure C11: Gobar gas cylinder



## APPENDIX D

## A KOREAN EXPERIENCE IN FERROCEMENT BOATS

by

Hun Chol Kim

In Korea, ferrocement was first introduced in late 1968 under the author's research project, "The Small Vessel Construction Utilizing Domestic Materials and Its Economic Analysis," at the Korea Institute of Science and Technology. The initial project lasted about three years, and is still being continued. A three volume report of about 500 pages and a number of other articles, practically all in Korean, are available.

The first volume of the report contains an exhaustive literature survey on ferrocement. The second describes the design and construction of a small experimental fishing boat 11m long which weighs 7.5 gross tons and was made at KIST (Figure D1); this boat is still floating today. The third volume analyses the results of various tests conducted on ferrocement materials.

A 25 gross tons 18m coastal fishing boat (Figure D2) designed at KIST was built and launched under our guidance in May 1969 by a local concrete pile manufacturer, who incidentally had never built a boat nor dealt with ferrocement before. As a follow-up, he is building a 5,000 gallon oil tank, a 48 ton fishing boat and a 600 DWT ton oil barge (Figure D3) in his new boat yard, built exclusively for ferrocement boats. This boat yard requires covering and heating during winter months.

The Korean Navy, with the assistance of the United States Navy, has also built some small craft of extremely thin ferrocement shell. A yacht building yard was initiated in the free-trade zone. However, the latter case is not related to our effort and will not be dealt with in this report.

Although our effort at KIST was rather modest, two of the boats have been in operation for about five years now and are deemed a success both technically and economically. At the same time there have been brought into focus a number of problems which I shall discuss further.

Technically, for a developing country such as Korea, one of the problems in building ferrocement boats is that there are not enough trained naval architects who can design ferrocement boats, i.e. naval architects with the expertise to analyse boats made of new structural materials and who can also come up with practical and locally accepted designs. Foreign drawings are easily available and are of help, but these require extensive modification because of differences in customs, traditions and fishing habits of the people. Until such time as there is enough work to support naturally a local group of people capable of providing designs at short notice, someone else will have to provide the necessary input.

The second technical problem is that of providing codes on design, building, measurement, inspection and maintenance. In steel boats, whether good or bad, classification and measurement rules are available. These have evolved from many years of experience and occasionally from experiences of disasters. Are we to adapt these requirements in designing ferrocement boats or are we to develop something new?

A couple of minor examples of technical developments needed in ferrocement boats are worth mentioning. Ferrocement boats require extensive use of fenders, and they have been found to be rather vulnerable in rough seas. Piping on ferrocement boats requires a different configuration from those on a similar steel boat.

With regard to plastering of the hull, a cheap, easy and dependable method must be developed. Perhaps licensing of technicians skilled in plastering work may be the solution, as is done with welders in steel work.

Apparent advantages, such as the possibility of wide applications, availability of labour and materials, easy maintenance and above all low construction cost (See Table D1), should facilitate the spread of ferrocement usage. However, the reluctance of Koreans to accept something new, perhaps due to ignorance more than anything else, is largely due to the fact that in ship building lives are at stake and high risks are involved. Someone must take the initiative and take the responsibility if and when a failure occurs.

Lastly, in a developing country like Korea, boats are purchased through outside financing as there are very few fishermen who can afford to buy an expensive boat outright, or even pay for a substantial amount of equity. More often, the financing terms will dictate what material is to be used and where such material should come from. In general, financiers do not like to take risks on an unproven material, even if it is economical. As a result there are many more wooden boats being built in Korea today, mostly financed with foreign loans, despite the replaceability and superiority of ferrocement.

## Comparative Hull Cost of a 25G/T Fishing Boat

(As of Sept. 1969)

	Ferro-Cement	Wood	Steel
Material Cost			
	Steel \$1,217	Imp. Wood 40m <sup>3</sup> \$4,667	Steel \$6,533
	Mesh 3,561	Doms. Wood 9m <sup>3</sup> 900	Welding rod 400
	Mortar 326	Others 1,790	Painting, etc. 3,000
	Others 555		
Labour	Man-day 616		550
	@ \$3.30		\$4.75
Sub-Total	7,711	10,016	12,500
Overhead 17%	1,311	1,703	2,125
Total	\$9,022	\$11,719	\$14,625
Price/G/T	\$361	\$469	\$585

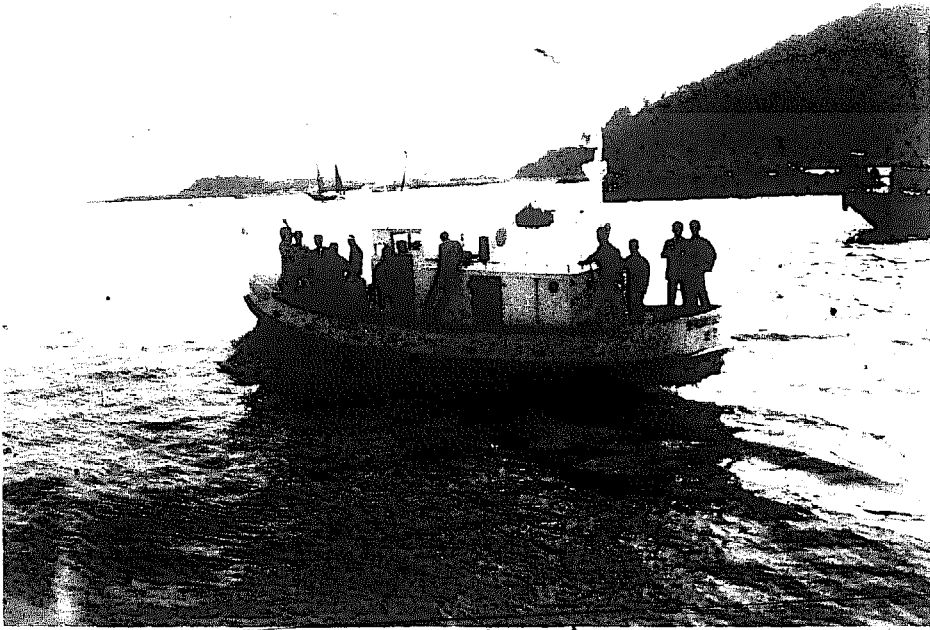


Figure D1: 7.5 G/T Fishing vessel made at KIST and launched in 1969

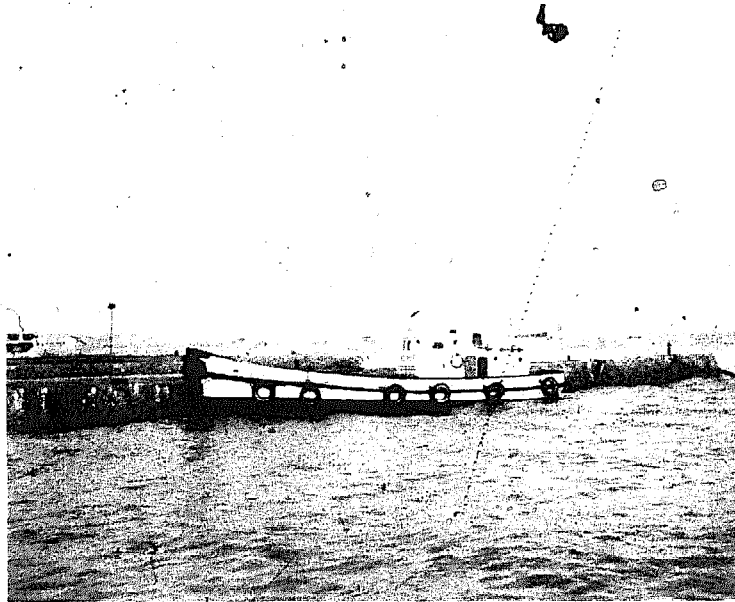


Figure D2: 25 G/T Fishing vessel launched in 1969

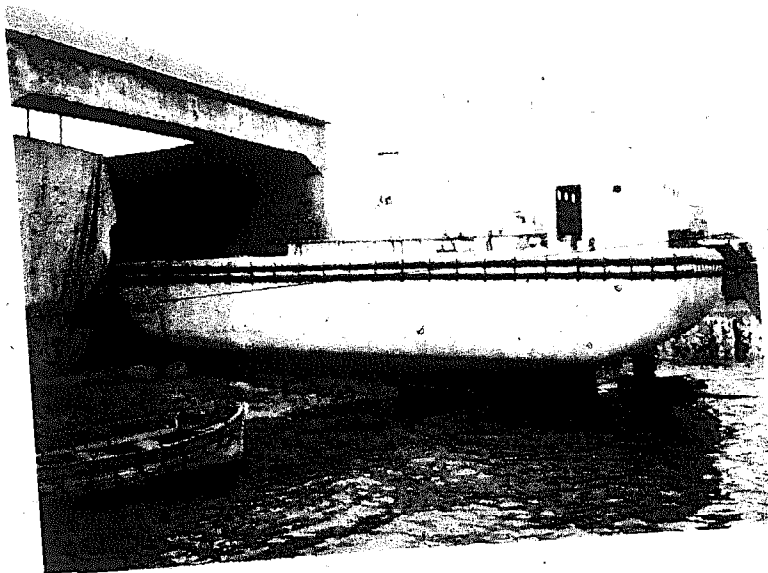


Figure D3: 600 DWT oil barge launched in 1974

## APPENDIX E

### FERROCEMENT ROOFING RESEARCH IN THE PHILIPPINES

by

P.B. Mejia and R.T. Tolosa

A prototype 3-bedroom residence with carport, whose shell is mainly made of ferrocement, was built in Iligan City, an industrial center in Southern Mindanao, Philippines. The ferrocement shell consists of a roofing system complemented by exterior wall panels. The shell normally accounts for the major cost of any dwelling structure. Although executed in ferrocement, the shell turned out to be comparatively cheaper than a similar dwelling using the conventional gauge 26 corrugated GI sheet or asbestos roofing, supported by wooden framing complete with ceiling/eaves and enclosed by an exterior 6" hollow block wall.

What made the use of ferrocement more economical than that of the conventional materials was the application of the following:

1. techniques of modular coordination with the use of standardized building components to allow mass fabrication and easier/faster construction methods;
2. design of a structural configuration which yields a stiff roofing system and framed thin-shell section of exterior wall panels, yet is functional in shape and pleasing, although the roof is revolutionary in appearance;
3. formulation of a mortar mixture that is impermeable without the use of expensive additives but still adopts proper curing methods.

The basic modular assembly is that of a symmetrical monopode which will be introduced in the commercial market as the HYPAROOF MODULAR ASSEMBLY. Many different floor plans for dwellings, shops, sheds, etc., can be made by merely arranging and joining together these modular monopods. Flexibility in floor planning with future provision for progressive extension, permits individuality in the appearance of structures, even if adopted for low-cost housing, without losing the advantages of modular coordination in fabrication and construction.

#### Notes on the construction

Figure E1 shows the modular assembly as monopod erected at the experiment site. In the foreground note one of the many experimental test modules previously cast. For this modular assembly, the roof module and precast column were cast-in-shop. Slight cracks formed in the roof modules when they were lifted in place without the benefit of heavy equipment. These were easily patched with mortar. The sample monopod is used to catch rain water with the downspouts plugged. There is no leak, attesting to the impermeability of the roof module despite the fact that no additive was used. The roof module can be mass produced in a plant under better quality control conditions and more sophisticated curing methods, and then installed in the site with heavy lifts.

A number of monopods, erected but not yet joined together, are shown in Figure E2. After all the pre-cast columns have been erected and joined to the in-situ footing, the

collapsible roof module form supported by movable scaffolding is installed in a one column unit. The pre-assembled steel and wire mesh reinforcements are properly positioned on the aligned module form, and then the ferrocement roof is cast in place. After 24 hours, the collapsible roof module form is dismantled, moved and reassembled on the next adjacent column unit. The monopod is shored and secured to adjacent monopods with wood clips. The clearances between monopods eventually become sealed ferrocement joints through which electrical conduits pass.

Figure E3 shows the left side elevation of the prototype house. All the roof modules were cast in place with a collapsible form supported by movable scaffolds. This is a labor-intensive undertaking. Note the ferrocement panel wall when plaster-finished in Figure E4. The wooden lattice-work between the panel wall and roof module is a standard component, but the design can be varied to suit the owner's or the planner's taste. It can also be made of ferrocement grilles.

### Technical details

The monopod modular assembly consists of two major building components: a cast roof module and a supporting precast reinforced concrete column which is erected on an in-situ concrete footing.

#### The cast hyperroof module

The thin-shell roof module consists of four hyperbolic paraboloidal quadrants by configuration which has a centrally disposed hole and bounded by stiffening ribs to provide an over-all rigidity along its sides. The inside shell of the roof module is provided with reinforcing members consisting of steel bars and wire mesh pre-arranged in position to define the four hyperbolic paraboloid quadrants. The reinforcement terminals are made to protrude, so as to join with other modules when installed as a roofing system for a desired floor plan.

#### Pre-cast reinforced concrete column

The nominal size of the columns is 0.20 by 0.20 meters, with a hollow core of 0.375 meter in diameter to act as downspout since the roof shell drains rain water from its edges and centrally down the hollow column. The column is reinforced by one-half inch round steel bars, with one-fourth inch round internal ties spaced at 0.20 meter on centers having protruding pipes at both hollow ends which act as connecting dowels to connect either to the in-situ footing or to the roof module.

#### Pre-cast wall/fencing panels

The lightweight pre-cast panel measures 0.825 by 2.10 meters. Its overall thickness is 0.025 meter, and it is bound on its periphery with stiffening ribs whose section is 0.05 by 0.10 meters. It is reinforced with one-fourth inch steel bars and G.I. wires, adequately spaced and made to protrude for joining provision with adjacent panels. The casting forms are made such that during manufacture open spaces for windows can be obtained or their overall dimensions can be altered, if used for perimeter fencing panels of the lot or septic vault sidings.

**Construction notes**

The mix proportion of the mortar used in the module is 1:2 parts of cement to sand. From 0.4 – 0.6 parts of water is added to get a workable mix. It takes about 1 cu.ft. of cement to cast one roof module.

The roof surface of the module is covered by sack and continuously cured for seven day. Then the column drain hole is plugged to allow ponding of water for some time, to test for possible leaks.

The reinforcement assembly of the roof module is shop-fabricated and installed in place on the forms at site. The main steel are welded to each other and the galvanized wires are meshed by hand in a weaving loom-like space pattern, conforming with the configuration of the finished roof module.

With a single roof-module form moving from one erected column to another, five roof modules can be cast in six working days by a crew of eight men including a foreman.



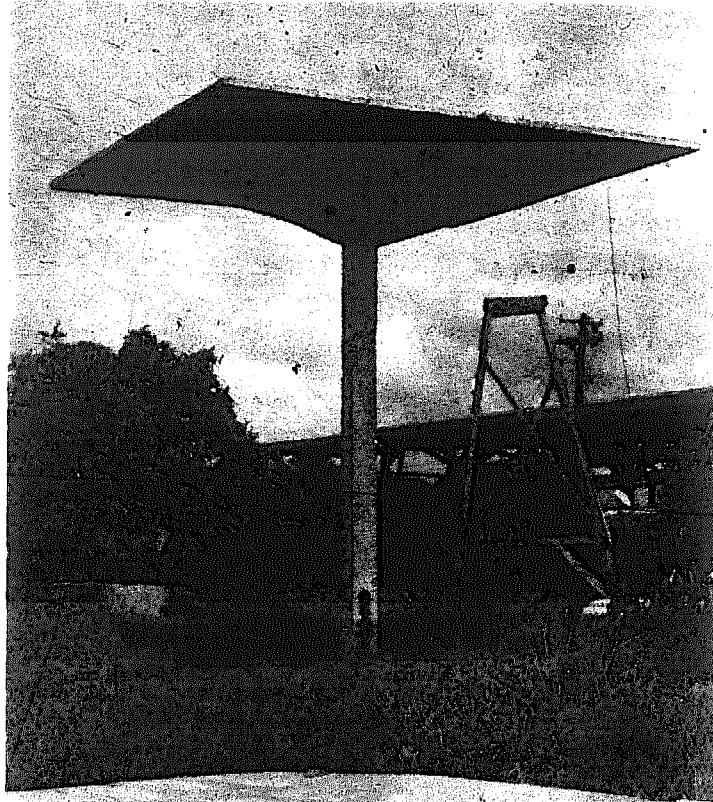


Figure E1: Typical roof module

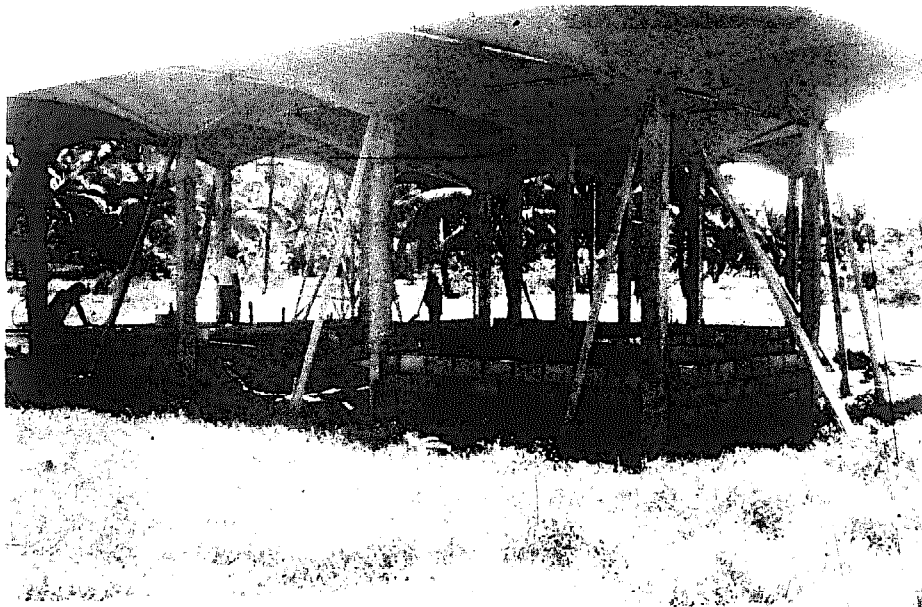


Figure E2: A number of monopods ready to be joined



Figure E3: Elevation of prototype ferrocement house



Figure E4: Elevation showing plastered walls

## APPENDIX F

## FERROCEMENT BOAT BUILDING IN FIJI

by

A. Sannergren

In most of the countries in the South Pacific, there is widespread unemployment and there are many hands that could be made useful if one could find something to keep them busy and — equally important — give them hope and pride in their work. This was one of the aims in building ferrocement boats in Fiji.

Most of the small island groups are far out from the main islands and it was important to find means for the people — not only the fishermen who could only afford to have small punts — to have boats which they could use outside the reefs and in which they could also transport their products to the mainland and/or the marketing centres. The Ministry of Agriculture, Fisheries and Forestry had used the old village organization — the matangali — to organize co-operatives which worked well together.

After discussions with the different persons involved, it was decided that, under existing circumstances, ferrocement would be the best material for the boats. Although timber is abundant in Fiji and the other island groups, to build wooden boats which could be used in rough conditions and outside the reefs, experienced boatbuilders were needed; moreover, timber is not rot or worm proof and requires considerable maintenance.

There was not much information available about ferrocement at the end of 1969 and the beginning of 1970, but there was some experience gained from building two tugs in Fiji with the advice of Mr. Morley Sutherland. The tugs are at present in good working condition.

Mr. Sutherland kindly provided the basic information about the material and methods of building a ferrocement boat. Tests on available materials were conducted, especially of the sand, and the design of the boat followed.

It was decided to build the boat in the simplest possible way by using bent pipe frames and existing materials such as chicken mesh and mild reinforcing steel. The cement and sand were of good quality.

The first boat was built at the Derrick Technical Institute as training for the boatbuilding apprentices and in cooperation with the cement and plastering experts at the same Institute. They were given the drawings, and assistance was provided in the purchasing of the materials.

Patterns for the frames were made so that the men could bend them with simple tools, and welding was avoided as much as possible. Simple methods of erecting the frames were introduced. Detailed procedures for placing the reinforcing rods and wire mesh were provided. Tying the mesh and rods together and plastering were done with commonly used tools.

The boat was built upside down (Figure F1), and plastering was done in one operation from the outside, with fairing of the inside; the plastering was completed in one day. The boat was subsequently cured for 28 days before being rolled over (Figure F2). Slump tests were conducted and test cubes were made.

The good results obtained with this boat encouraged the Fisheries Department to build a series of five boats, of length 30 feet and beam 12 feet. Since the fishing cooperatives had very little money, it was decided to build them as cheaply as possible. It was arranged that

the men from the villages should live on the boat building site, supply their own food and build their own boat.

During the construction of the first boat at Derrick Technical Institute, men were trained in the more complicated work, such as installing the engine and fitting out the boats. All handworks were made by the fishermen, and during the construction they gained experience which can be used in the future both for the repair and maintenance of their own boat and for the construction of other boats.

It was impressive to see the reaction of the villagers when the boat was launched and the celebrations that followed when they came back to the village.

Other boats were later built, using different types of framing, and they too proved to be good and efficient boats for the fishermen. During a bad hurricane the boats really proved themselves and demonstrated how simple it is to repair them.

Two boats were blown over the reefs, up on the beach and in among the coconut palms. One had only some scratches and could be refloated almost immediately. The other unfortunately struck a large coral block and one side was crushed with a hole about six feet by two feet. The crushed cement mortar was removed, the wire mesh was straightened up and some new wiremesh and reinforcing rods were applied. Concreting followed with the use of simple tools available in the village. Within about three weeks the boat was refloated. If it had been a wooden boat it would have been a complete wreck.

It is of interest to note the growing popularity of ferrocement in Fiji. In the Government Shipyard in Fiji, ferrocement was used for surfacing floors and walls in refrigerated holds and for building pontoons for lighthouse foundations. In order to train technical staff, designs and cost estimates for ferrocement boats of different sizes were made, and it is hoped more ferrocement boats will be built soon.

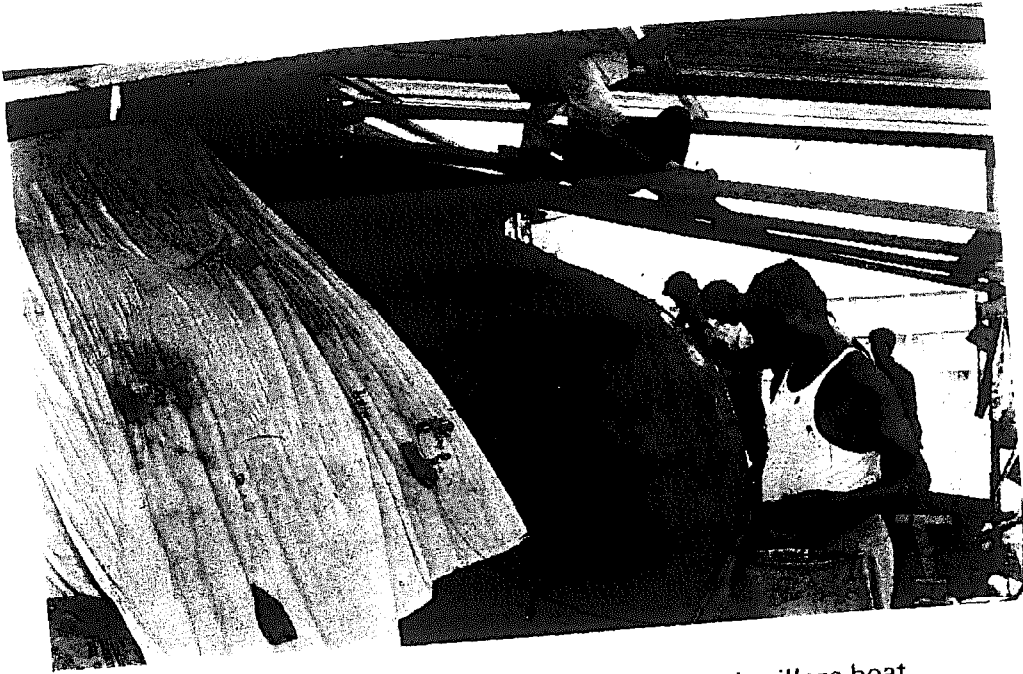


Figure F1: Villagers in Fiji plastering their village boat

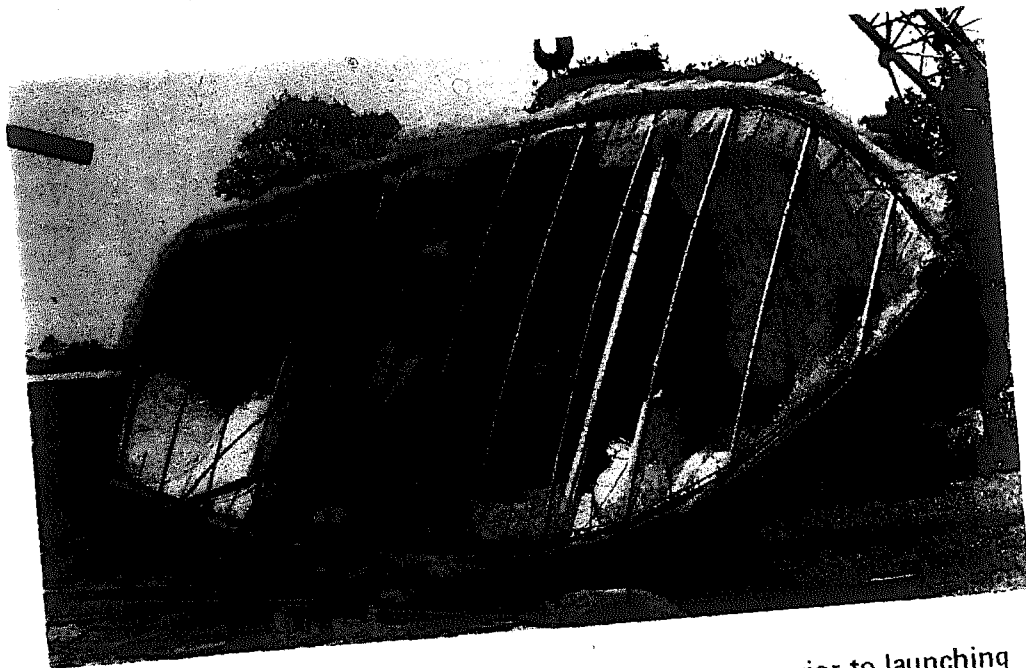


Figure F2: The hull of the village boat is rolled over prior to launching

## APPENDIX G

### RICE BIN FOR RURAL FARMERS\*

by

O. Phomratanapongse

It is estimated that the loss of rice paddy due to insects, birds, fungus attack and spillage is as high as 20%. In Thailand where the annual production of the rice crop is 12 million tons, this loss amounts to 2.4 million tons, valued at U.S.\$120 million at the current market price. The Asian Institute of Technology and the Applied Scientific Research Corporation of Thailand have developed a ferrocement rice bin with a capacity of 3 tons, and in 1970 the cost of the bin was U.S.\$120. The major cost component of this ferrocement bin is that of the reinforcement. It was felt that if the reinforcement could be reduced or completely eliminated it would be possible to design low-cost rice bins which would be within the economic reach of the farmers.

#### Construction Details

A trial rice bin made of unreinforced cement mortar was built in Bangkok, using paddy husk as the internal mold. The bin can store 2.8 cu.m. of rice paddy. It is conical in shape with a circular base plate, as shown in Figure G1. The diameter of the cone at the base is 2.8 m. and the height is 1.4 m. The wall of the bin is 2 cm. whereas the base is 5 cm. thick. These dimensions were chosen such that a man could reach the top of the bin without having to step on the paddy husk heap during construction. A bigger bin can be built by simply increasing the diameter of the base.

The construction started by building an embankment of compacted earth about 60 cm. above the ground. This height is dictated by local factors such as ground water level, maximum flood elevation and method of loading and unloading rice paddy. A layer of coarse sand 10 cm. above the embankment is added to stop capillary water. The unreinforced base plate is cast using cement mortar, and a ring beam is provided along the circumference of the base, as shown in Figure G2. In the trial bin, the cement-sand proportion was 1:2 by weight and the water-cement ratio was 0.40. The base plate and ring beam were cured by keeping water in the base for 3 days. After the curing period, a pile of paddy husk was placed on the base and a conical mold was formed by wetting and tamping the husk into shape. In the absence of paddy husk, sawdust or sand can be used as mold. The mold is sprayed with water just before plastering. The mortar used for the wall was of the same mix proportion as used in the base. The plastering of the wall is done in two layers, each layer being approximately 1 cm. thick. The plastering operation started from the base to the top. The thickness of the wall is measured by piercing the wet wall with a small piece of wire.

After plastering and before the mortar sets initially, the top of the bin is cut about 15 cm. from the top. The upper lid is used as cover of the bin. A rectangular opening is also made near the base for unloading the rice paddy. A rectangular slab is specially cut to be used as the door for this opening. The bin is cured as in ordinary plastering work, and subsequently the paddy husk is removed. In 1973, the cost of this bin was U.S.\$10.

\* This bin described in this Appendix has no reinforcing mesh and is not strictly ferrocement. Nevertheless it is an extension of ferrocement technology and is included here because of its importance and because it was first reported at the Workshop.

## Field Tests

The bin was loaded with rice paddy on June 26, 1974 to a height of 1.07 m. above the base plate. The lids of all openings were sealed with cement mortar. The test results obtained are as follows:

(a) Temperature

The temperatures inside the bin were recorded at three different levels, i.e., on top of the paddy, at 47 cm. and 17 cm. above the base plate. In general the readings obtained at the two lower levels were fairly constant at 30°C. At the top, the temperature varied from about 22°C in the early morning to 27°C at mid-day. Outside the bin the maximum temperature recorded was about 32°C at mid-day.

(b) Moisture Content

The moisture content of the grain was measured at the time of loading and was 12.11%. After three months of loading, the average moisture content was found to be only marginally higher at 12.66%. This showed that the bin was water tight and is capable of maintaining the moisture content of the rice paddy.

(c) Carbon Dioxide and Oxygen Content

The carbon dioxide content increased from 0 at the time of loading to 3.7%, 10% and 11.70% after 1 month, 2 months and 3 months respectively. The oxygen content decreased from 20.4% at the time of loading to less than 10% after 1 month.

(d) Germination

The germination decreased rapidly and this was probably due to the fact that the rice paddy was stored some 6 months after harvesting.

(e) Insect Attack and Others.

After 2 months, no insect or rodent attacks were observed. In fact insects trapped inside during storage were found dead.

(f) Starch Quality

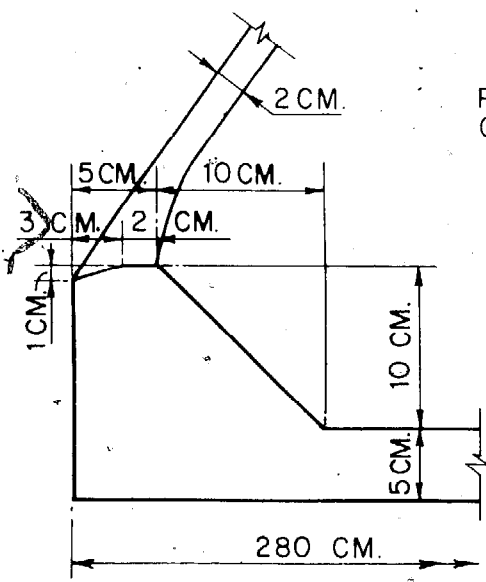
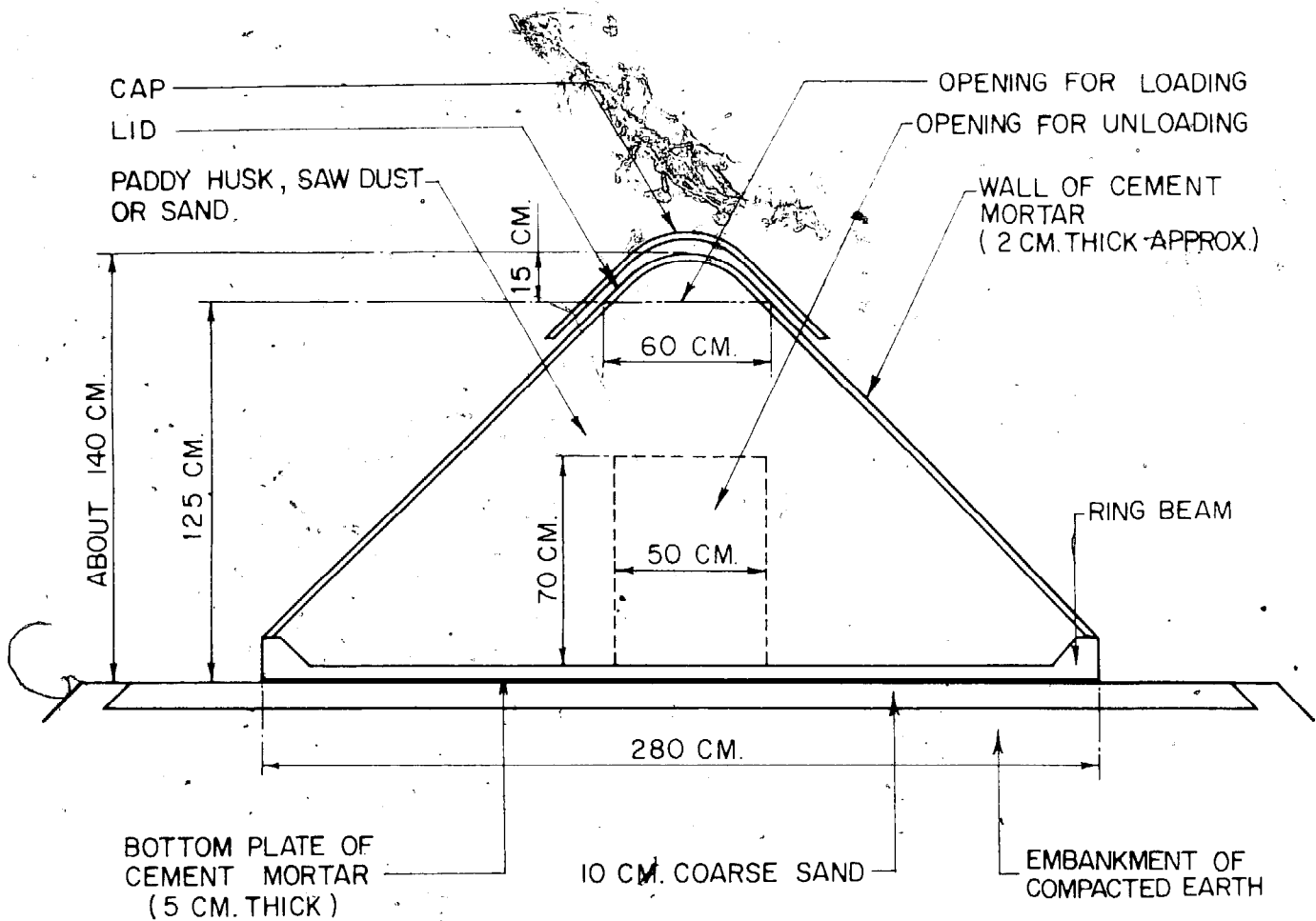
There was no significant change in the millability, chemical and physical properties of the starch due to storage.

In conclusion, the bin described here requires a very low level of technology to build and it could be easily adapted by farmers. It is low in cost and is well within the means of farmers. The field tests showed that the bin provides adequate grain protection against insects and other environmental hazards.

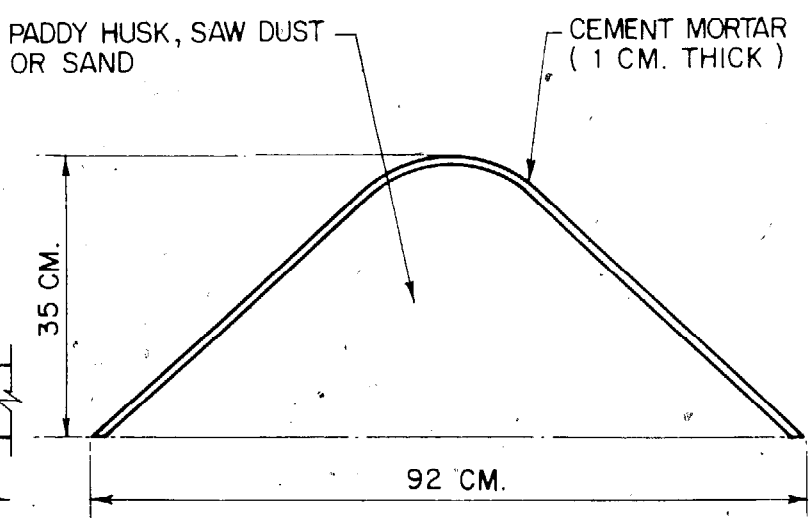


Figure G1: Completed cement mortar bin





DETAIL OF RING BEAM AT BOTTOM PLATE



DETAIL OF CAP

Figure G2: Details of cement mortar bin

APPENDIX H  
 FERROCEMENT BOAT CONSTRUCTION  
 AT THE ROYAL THAI NAVY SHIPYARD

by

T. Makarananda, S. Sarakashetrin and V. Chomchuenchit

The Royal Thai Navy shipyard has been constructing prototype ferroceement boats to acquire the necessary technical experience for the benefit of both government and public sectors. The idea of building ferroceement boats arose from the fact that the usual materials for hull construction, i.e. wood, steel, and fiberglass, have become more expensive. Ferroceement is made from locally produced materials which can be easily found in Thailand. The construction method is simple and the skills required can be learned easily.

In addition to the experimental work on ferroceement boats, some work on the construction of ferroceement floating docks and pontoons is also being carried out. Figures H1 and H2 respectively show the experimental catamaran and pontoon built at the Royal Thai Navy Shipyard.

The construction methods used in building ferroceement boats can be classified into three different categories:

- (a) Open pipe frame method
- (b) Cedar mold or the inverted wooden mold method
- (c) Open mold method

The Royal Thai Navy Shipyard has experimented with the construction of small boats, so the Cedar mold method was selected. This method is slow, because the wooden mold has to be stripped out after curing the exterior plastering, and then plastering of the interior follows. However it is also simple and can be achieved with unskilled labor. After gaining more experience, other construction methods were tried.

At present, in designing ferroceement boats, there is no classification which specifies what method should be used in the design of scantlings. Therefore, in the planning and design of the experimental ferroceement boats, knowledge and techniques gained from construction of other types of boat were employed.

The materials needed in ferroceement construction, such as portland cement, river sand, wire mesh and reinforcing rods, are all available locally. In our experience, a cement-sand proportion of 1:1.25 by weight and a water-cement ratio of 0.40 seems to be an adequate mix proportion. No admixture is used in the mix.

The first experimental boat built was a substitute for a local boat, called a sampan, and had the following dimensions:

Length	4.80	m.
Beam	0.82	m.
Depth	0.38	m.
Hull thickness	5/8	in.
Weight	200	Kg.

The boat was tested after the interior decoration was added. It was found to have a good buoyancy, and the maneuverability is as good as that of a similar wooden boat. The sampan has a carrying capacity of 200 kg. Buoyant sections were later added to the forward bulkhead and transom to prevent the boat from sinking.

The second experimental boat was a small passenger boat with twin bodies resembling a catamaran. It is powered by two outboard engines. The dimensions are as follows:

Length	11.50 m.
Beam	1.20 m.
Beam (twin)	4.00 m.
Depth	0.80 m.
Hull thickness	3/4-1 in.
Weight (one boat)	2,500 Kg.

With two outboard engines the boat has achieved 7.5 knots in test runs. This is quite slow. Similarly, buoyant sections were added to both forward bulkhead and transom to prevent the boat from sinking.

It is worthwhile discussing some interesting points encountered in the construction of these experimental boats.

**Plastering:** The mortar was pushed from one side but it did not penetrate through the mesh and the whole area. Chemical admixture was added to ease the plastering work. It was observed that the boat could not easily be constructed by the local people.

**Curing:** The mortar was cured by continually spraying it with water, and this delays the next stage of construction. It causes unsightly rust at the tips of steel ties which protrude from the plaster. Since the hull was not continually wet shrinkage cracks appeared on the surface.

**Hull cracks:** Hair line cracks were observed on the hull. These may be due to the knocking of the mold frame or improper curing. They are very small, however, and after the application of epoxy paint no leakage was detected.

**Repair:** The boats are easy to repair and damage is rare if proper precautions are observed.

**Cost:** The experimental ferrocement boats were cheaper than wooden boats of comparable size.

The main problem associated with ferrocement boats is the weight, which reduces the speed of the boat. If somehow the weight can be reduced ferrocement can be made competitive with other materials. Lately, the Royal Thai Navy has been experimenting with the construction of a floating ferrocement dock, to enable our technicians to gain more experience in ferrocement construction.

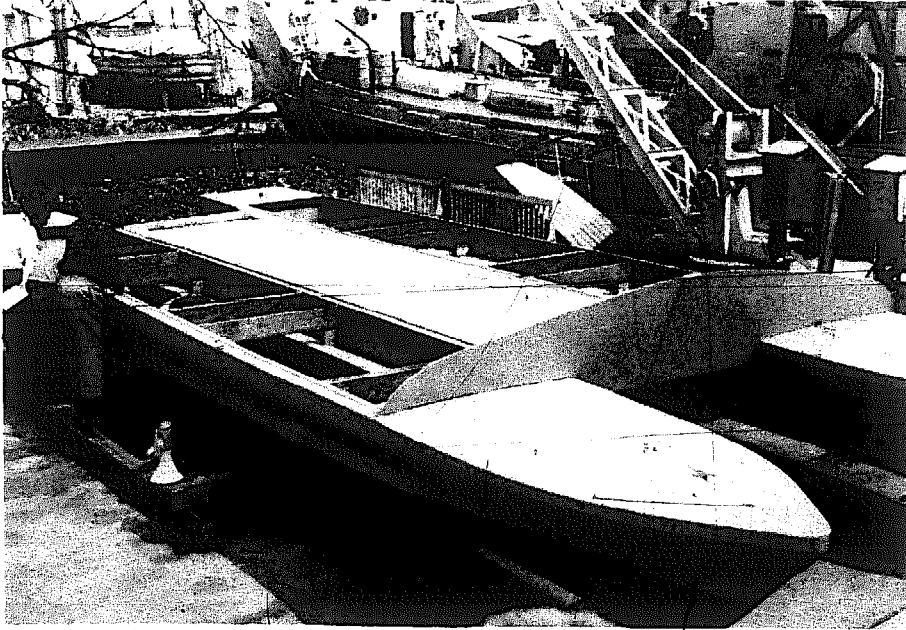


Figure H1: Experimental ferroceement catamaran

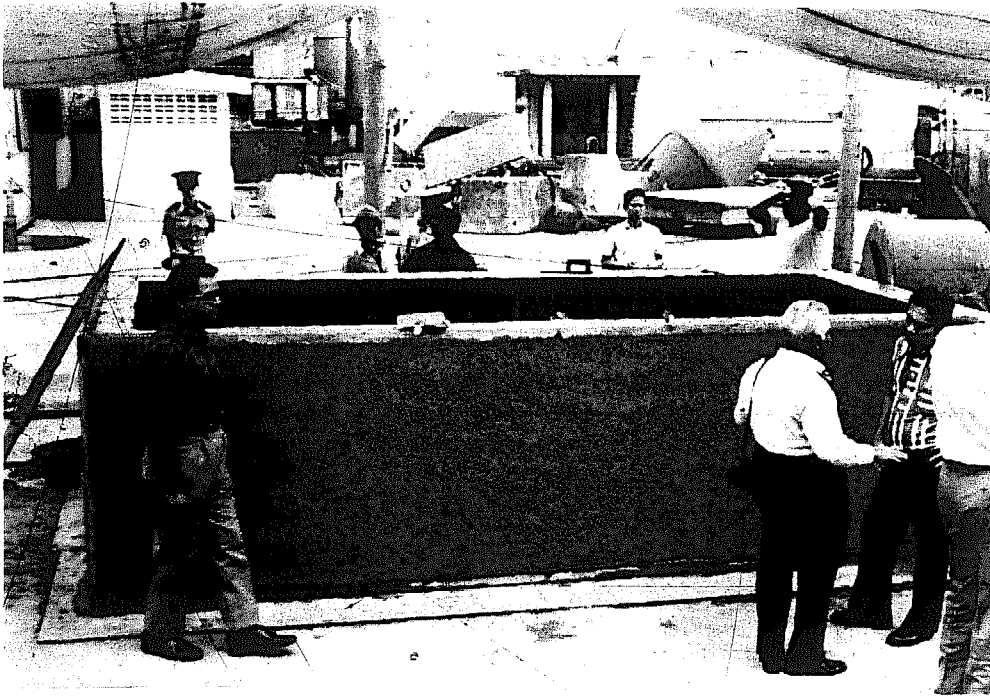


Figure H2: Ferroceement pontoon

# APPENDIX I

## FERROCEMENT HOUSING IN PAPUA NEW GUINEA

by

H.M. Moar

### Introduction

A system of precast ferrocement housing was developed to meet a demand in Papua New Guinea for earthquake and storm resistant low cost housing, a demand which was created by a shortage of local treated timber and the unsuitability of corrugated iron roofing and asbestos cement sheet cladding. This unsuitability was highlighted by the Darwin cyclone disaster, which led to asbestos cement sheeting being declared unsuitable by the Papua New Guinea government for future Housing Commission houses.

### General Description

The houses were assembled from panels which were approximately 3 metres wide by 2.4 metres high. Roof elements were 6 metres by 3 metres and were the heaviest element in the system, weighing 680 kilograms.

Windows and door frames were cast in at the factory. Generally the panels were 13 mm thick and were made from one layer of Watson mesh imported from New Zealand. The average sized house, consisting of two bedrooms, a living room, a lean-to kitchen and a detached shower/toilet unit, costs approximately US\$4,000 when finished in place.

### Method of Manufacture

The Papua New Guinea partner in the joint venture operated a large pre-casting and concrete manufacturing yard and so the operation was designed to suit these existing facilities. The panels were therefore pre-cast to allow for controlled manufacture in volume, but they were limited in size and weight to allow for easy transportation and erection using simple equipment. The pre-casting was done in an open yard over concrete moulds and using hand operated gantries for stripping and stacking. The total cost of setting up the yard and the crane was approximately US\$40,000 for a yard designed to produce three houses per week using standard water curing techniques.

This method has proved to be relatively low in establishment cost, can be operated using relatively untrained labour and can yet produce a very acceptable standard of finished product.

Buildings of similar reinforcing content and style have been built in New Zealand using in situ methods and also by casting off-site a complete room unit consisting of floor, walls and roof. All three methods appear to be viable and it would depend on volume and available equipment as to which proved the most suitable in any one situation.

### Advantages

Although the 13mm thick plastered roof or walls do not possess any insulative qualities in themselves, they effectively reflect radiated heat and maintain an atmosphere inside the houses equivalent to the outside shade temperature of the area. The walls are clean and smooth inside and therefore easy to keep clean. The houses are relatively indestructible and highly resistant to storm damage. The material is durable, with a life span of any high quality concrete product. In Papua New Guinea the houses have proved competitive in cost with the more usual temporary low cost housing.

The system utilises local labour and low cost materials. For a factory operation it is feasible to purchase a mesh machine to manufacture mesh on site.

### Summary

Ferrocement housing systems should be designed for local preferences with regard to design and layout, and the method of construction should take into account available labour skills, equipment and market requirements. Although ferrocement housing systems can be designed to be fully competitive with low cost housing, they should not be limited in concept to this, as they have built-in an inherent high quality and can be therefore adapted to meet any housing standard required.

## APPENDIX J

## FERROCEMENT CONSTRUCTION IN BANGLADESH\*

by

G.W. Bigg

## INTRODUCTION

The Canadian Hunger Foundation initiated a project in July, 1972, whose aim was: "to ascertain the acceptability of ferrocement country boats through the transfer of an appropriate ferrocement boat building technology to the people of Bangladesh with a view to facilitating the establishment of a ferrocement industry in Bangladesh". On the basis of an initial feasibility study (1) a pilot project was initiated with the Bangladesh Jatiya Matshyjibi Samabaya Samity (National Fishermen's Co-operative Society) herein referred to as BJMSS. The objectives were to develop a small boatyard facility for ferrocement construction, train workmen to build a number of ferrocement vessels of local design under the supervision of the writer and to ascertain the technical, sociological and economical acceptability of the material for Bangladesh.

## Project Outline

The project was executed in four phases from early 1972 until August, 1975. Phase I (Feb. — Aug., 1972) identified the basic form and scope of the ensuing project as a result of a project feasibility study (1). Phase II (Aug., 1972 — June, 1973) was the project development phase. In collaboration with BJMSS, two indigenous designs were identified and converted for construction in ferrocement. A pilot facility design was established and BJMSS undertook the responsibility of construction of the facility to be ready by the first of June, 1973. Also, during this phase of the project, the necessary government approvals were obtained for the funding and administration of the project.

Phase III was initiated in June, 1973, and ran until June, 1974. The facility was completed by September, 1973, and the keel of the first boat laid in October, after a preliminary period for material procurement, hiring, and initial training projects. The building of prototypes and the training of personnel continued under the direct management and financial control of the project until June, 1974. In June, 1974, all of the assets of the boatyard, including tools, stocks of materials, finished and unfinished boats, were formally turned over to BJMSS who then assumed complete financial and managerial control over the boatyard and its personnel. One of the conditions of the turnover was that BJMSS was to provide a full-time boatyard manager to oversee the progress of the facility and to be responsible to BJMSS for the management of the yard and its personnel. Progress up to the end of Phase III is given in Reference (1).

Phase IV was initiated in June, 1974, to run until August, 1975, to provide suitable time for transition from a foreign-controlled project to a locally-controlled project. BJMSS assumed complete control; however, the writer was available for substantial periods during

---

\*Taken from the report "Ferrocement Boats for Bangladesh: Appraisal for the Future" submitted by Ferrocem International Co., Ltd. to the Canadian Hunger Foundation.

the year in the capacity of advisor to the boatyard. In addition, two new designs were converted to ferrocement, additional workmen were trained and the technical foreman was given training in elementary boat design and lofting. The project also assisted BJMSS in the procurement of cement and some tools which required foreign exchange.

### **Boat Designs**

Four indigenous designs were chosen by BJMSS for conversion to ferrocement construction. There are at least 100 different boat designs to choose from in Bangladesh and many are suited for conversion to ferrocement. As BJMSS were concerned with the fishing sector, the four vessels chosen were primarily used for fishing or fish carrying.

### **Balam**

The essential details of the Balam Design are given in Table J1. This was the first design prototype built in the boatyard and the first vessel to see service in the Bay of Bengal.

The wooden balam design is actually a class of mechanized boats which vary from beautiful seaworthy craft to unsightly, poorly-made uncomfortable boats. Formal design work, drawings and calculations for these boats are practically non-existent. The vessel chosen for conversion appeared suitable, was available for measurement and was considered by local boatbuilders and fishermen to be representative. It became apparent, however, that there were inherent design flaws in the vessel (not related to ferrocement), that made it desirable to change the design after an initial series of boats were built. The vessels were satisfactory, but substantial improvement could be made. As part of Phase IV, an extensive re-design of the Balam was initiated by the technical manager, as part of his training, under the guidance of the project advisor. The prototype of the new Balam is currently under construction.

### **Cox's Bazar Boat**

The wooden version of the Cox's Bazar boat has evolved in several identifiable stages from a dugout with stitched topsides to a relatively modern mechanized fishing boat which is engaged in fishing the Bay of Bengal primarily from the Cox's Bazar area. The Balam is a larger, modified, fully decked variation of this boat. Most development schemes for the Bangladesh fishing sector suggest that this vessel be built in large numbers. The essential specifications are found in Table J1. It is anticipated that this vessel will be a popular design in ferrocement.

### **Chandi**

The Chandi is used in the rivers and estuaries of Bangladesh as a non-mechanized fishing boat and general purpose country boat. It is probably the most numerous type in the country and the fleet was extensively damaged during the major cyclone of 1970. Reconstruction schemes by several Bengali agencies have been proposed for the rehabilitation of the Chandi fishery. However, most have been hampered by the unavailability of suitable timber and the rapidly rising costs.



The wooden chandi is an undecked open boat. There was some evidence to suggest that an empty chandi would float if swamped. It was, therefore, decided that the ferrocement design would be partially decked with watertight bulkheads so that it was also buoyant if the center compartment flooded while carrying a 5-ton payload.

The design chosen for prototype construction is given in Table J1. It was found that the addition of ferrocement watertight compartments and the framed construction method made this design too costly in manhours and materials, and it would require an extensive redesign before it would be commercially viable in Bangladesh.

### **Jele Noaki**

The Jele Noaki is a non-mechanized river country boat used for fishing and general purpose in the smaller rivers of Bangladesh. This design was the smallest attempted in ferrocement and it incorporated novel building techniques. The basic design features are given in Table J1.

### **Grain Storage Silo**

As part of Phase III, a 10-ton capacity grain storage silo was designed and built in ferrocement with an experimental bamboo core to replace the steel reinforcing steel. A complete discussion of this silo is given in reference (4) and will not be repeated here.

### **Water Tank**

A ferrocement water tank was designed and fabricated during Phase IV. The tank had a capacity of 400 gallons. This tank could also be adopted for use as a small grain storage silo and would have a capacity of approximately two tons. Water tanks of this capacity are common in Bangladesh and they are used for residential and business rooftop storage. The tank is usually fabricated of 18 ga. galvanized sheet in Bangladesh, a material of high cost and limited durability. It was noted that the steel tank installed in the boatyard had started to leak after 1½ years of use.

### **Materials and Processes**

Within limits, ferrocement is an adaptive material both in the constitutive materials that make up the laminate (mortar plus reinforcement) and in the method of fabrication. In the pilot project, a variety of alternatives were tried, some based upon the requirements of the local situation in Bangladesh, some upon the experience of the boatyard during the course of the project and some for training purposes to provide the technical personnel with alternatives.

### **Mortar**

The ultimate success of ferrocement depends largely on the quality and placement of the mortar. The reader can appreciate that the ingredients for good ferrocement mortar are essentially of the same standard as for marine grade concrete (with the absence of large

aggregate) and must be manufactured and placed with similar stringent controls. This discussion will be concerned with such practices or deviations as applied to the conditions in Bangladesh.

Mix design in the country was governed by the following constraints:

- i) Cement: As discussed previously, (1) cement in Bangladesh, now and for the foreseeable future will be a problem. Locally produced cement represents about 10% of the country's needs and is of inferior quality. Cement does not keep for long in the hot humid monsoon season so a steady external supply would be necessary for long-term production of ferrocement products. Local supplies of originally acceptable cement are not reliable both for quantities available and quality at the time of sale (age and alteration).

For the pilot project, as the cement aged (started to cake) the larger lumps were screened out and the sand:cement ratio was decreased from 2:1 to 1.5:1 by weight until the cement was rejected as unsuitable (by cube test when available). Aged cement was used on the pilot project as it was recognized that this would certainly be tried at a later stage by the BJMSS-managed yard.

- ii) Sand: Good quality mortar sand is available in Bangladesh but expensive. The major supply comes from rivers in Sylhet. Acceptable sand can be found near Chittagong at a much cheaper rate but it does not have a good grading curve (even when mixed with other sands) and produces a harsh mix.
- iii) Additives: Normally ferrocement mortar is prepared with pozzolanic additives to improve impermeability and workability and a water-reducing agent to improve workability at the low water:cement ratios used. Such additives were not available during the course of the pilot project in Bangladesh and it was felt that they were in the category of a convenience rather than a necessity for the pilot project. It would, however, be desirable to establish either a local supply or import these items for a large scale project.
- iv) Mortar Application: The mortar used in ferrocement marine applications is very stiff and in general requires vibration for placement and proper consolidation. A two stage plastering technique was required in Bangladesh for a variety of reasons. First, the stamina of the average workman was low and the plastering job had to be broken up into smaller units. Second, the unplastered reinforcement is not a good foundation to vibrate mortar through. Consequently, the first layer of mortar was pushed through the mesh as far as was reasonable (usually better than halfway). The remainder was back plastered after several days of curing and placed with vibration.

It was found that the most suitable vibration was provided by heavy duty orbital sanders suitably modified. The harsh environment was hard on the sander bearings and they would only last for one or two boats before requiring repair or replacement. Although a low-cost item in proportion to the cost of a boat, the replacement of such vibrators (not available in Bangladesh) is a problem for the continued operation of the pilot boatyard. A larger-scale project could make use of reliable, alternative methods of providing the vibration.

## Mesh

Mesh is available in a variety of sizes and types in Bangladesh and its manufacture is both a cottage and factory industry. It is the single most costly component of a ferrocement boat and the price of the mesh, naturally, greatly influences the competitiveness of the material. It is economically attractive for Bangladesh that approximately three quarters of the market price is a result of secondary manufacturing within the country. Although mesh was available during the pilot project, it can be expected that there could be shortages from time to time. It is also expected that with a stable large scale market, the price can be expected to fall.

## Reinforcement Steel

At the start of the project, an order was placed with a local manufacturer for 8 tons of no. 4 harddrawn steel rod, as this was the most suitable reinforcement available in Bangladesh in July, 1973. This quantity was sufficient for the project through August, 1975. The BJMSS manager has not been able to repeat the order, so the boatyard may be required to substitute M.S. rod in the future. Three-eighths diameter M.S. rod was used as the primary reinforcement for frames and stringers and appears to be in good supply.

Rod material in Bangladesh comes in tight rolls or twenty-foot lengths bent double. Considerable manhours were expended straightening the rods to provide a fair lay-up for frames and/or on the hull. This was an acceptable inefficiency for the pilot project; however, the quality of the straightening was not high and in a commercial production, it would be highly desirable to have a mechanical steel straightener.

## Wood

Ferrocement boats can require wood for superstructure, collision protection, engine beds, in some cases decks and, as in the case of the Jele Noaki, hull filler material. It is a scarce, high-priced, low quality material in Bangladesh and wood for boat building must compete with a large variety of other uses. In most instances, for ferrocement construction, inferior grades of wood can be utilized and these are usually available.

## Construction

Ferrocement is difficult to define as a material for it can be made up from a variety of constitutive materials by many different techniques to achieve essentially the same results. It requires experience to build with the material and in order to give the boatyard personnel as much experience as possible in the short time available for the project, several construction methods were tried. This not only gave the project an opportunity to experiment with the most suitable techniques for Bangladesh, but also gave the boatyard workmen depth of experience. The value of this experience was in evidence during Phase IV when under local technical supervision the construction techniques continued to be upgraded by local initiative.

## Balam

During the pilot project, a Balam hull was built both rightside up and upside down. After this experience, the technical manager (Bengali) chose to build subsequent boats rightside up as he was more comfortable with that technique. In a larger scale facility, with appropriate materials handling equipment, the advantages of upside down construction would prevail.

The Balam was constructed of a nominal one-inch thick skin with 3" frames on 2" centres. The frames were fabricated in molds with one mold for each frame station. The frames were webs of 3/8" steel bar covered on both sides with two layers of mesh.

The hull layup consisted, in the first boat, of one layer of no. 4 hard drawn steel bars on 2" centres running longitudinally with three layers of 1/4" x 1/4" x 20 ga. square woven mesh on each side of the rods. Subsequent to the first vessel, the mesh used was two interior layers of 1/2 x 1/2 x 20 ga. hexagonal mesh on each side of the rods plus one layer of 1/4 x 1/4 x 20 ga. woven mesh on either side of this.

After the skeletal steel, including the frames, floors, stringers, deckbeams, keel and engine beds had been erected, faired and welded into a largely self-supporting structure, the inner layers of mesh were loosely applied to the frames. The no. 4 rods were then placed and the outer layers of mesh. The assembly of 6 mesh layers and the longitudinal rod layer was then tied into a compact steel mat approximately 3/4" thick with an average of 16 ties per sq. ft. of surface. With a cover estimated at 1/8", the finished hull skin with mortar was approximately 1" thick and weighed about 12 lb/sq. ft. The deck of the Balam used the same skin layup as the hull; however, four inch frames were used for deck beams. A typical Balam is shown in Figure J1.

## Cox's Bazar Boat

The hull mesh and rod layup for the Cox's Bazar boat were the same as for the Balam. The prototype was built in Phase IV of the pilot project. Figure J2 shows the Cox's Bazar Boat before plastering.

## Chandi

The Chandi was designed for upsidedown construction with a permanent reusable mold to mark the sheer and support the frames during construction. The method of construction was similar to that for the Balam, in that permanent frame molds were built from which the frames could be reproduced for subsequent boats by relatively unskilled labour. The frames were 2 and 3/4" deep on 2" centres and fabricated of no. 4 HD steel rod. The hull consisted of one layer of no. 4 HD rod on 3" centres running longitudinally plus 3 layers of 1/2 x 1/2" x 20 ga. hexagonal netting on each side of the rods. Figure J3 shows the plastered hull of the Chandi.

## Jele Noaki

From experience gained in the design and construction of the Chandi, it was decided that the Jele Noaki (a very small boat for ferrocement) would be unacceptably heavy and expensive to fabricate by techniques used on the bigger vessels.

The design of the Jele Noaki required an unframed vessel as it was built over a permanent open male mold which was easily removable and reusable as shown in Figure J4. To increase the stiffness of the hull in the absence of frames and stringers, a core of 3/8" x 3/4" wooden battens on approximately 1/2" centres were substituted for the no. 4 steel rods of other designs. Three layers of the hexagonal netting were placed on either side.

The mesh and battens were applied to the mold and the hull was plastered from the outside. The vessel and mold were then turned over, the mold removed and the hull was grouted and back plastered from the inside after supports for the thwarts and the mast step were installed.

### Grain Storage Silo

The silo was built in two stages as described in reference (4). The base and top were fabricated on an open mold with two stage plastering. The top was supported above the base and the bamboo core of the cone was tied to connecting rods, the mesh applied and the cone was then plastered. The internal bamboo core was intended as a support for construction and to provide a spacer to make the mesh more effective in bending. The mesh was extensively tied to the bamboo in order to provide mechanical bonding. Two layers of 1/2" x 20 ga. hexagonal mesh were used on both sides of the bamboo, both side and bottom with additional reinforcement at points of high stress.

The techniques evolved in the experiment were used to advantage in the construction of the Jele Noaki in Phase IV.

### Start-Up Experiments

As described in the report for Phase III (1), there was a three-month delay before the facility was available for boat construction. During this time, two small projects were initiated and completed. Firstly, a mock-up of a section of the Balam hull was fabricated for demonstration purposes and to start the training of the unskilled newly-hired workmen. The mock-up proved to be invaluable for rationalizing some initial design and construction decisions.

Secondly, a rotten abandoned wooden 16-foot sampan was reclaimed by sheathing with a thin layer of ferrocement and used as a tender for the remainder of the project. This was highly successful and gave several years of additional life to an otherwise worthless boat. The wooden hull remained in place and was covered with two layers of no. 4 - 20 ga. sq. woven mesh and plastered. This technique should be explored further for reclamation of old wooden boats in Bangladesh.

### Costs and Time

Prices of materials in Bangladesh varied widely and rapidly during the course of the pilot project. Although the costs presented in the following sections are based upon the prices of June, 1974, they can only be used as indications of costs of materials and their relation to one another.

## Balam

The balam is a framed vessel complete with engine, superstructure, insulated fish hold and deck. It has a ferrocement hull surface area of 801 sq.ft. A summary of manhours and material costs is given in Table J2.

The first prototype required 6995 manhours to complete the ferrocement hull and deck and this has been reduced to an average of 5182 manhours by May, 1975 (26%).

After five boats had been built, the average recorded manhours to complete the entire vessel was 8170 manhours. This is a high number (low productivity) but it does represent the low physical fitness and motivation of the worker.

The hull, deck, frames, bulkheads represent a total of 1510 sq.ft. of ferrocement and it takes 5182 manhours to complete or 3.43 manhours per square foot of ferrocement or 6.47 manhours/sq. ft. of hull.

If the hull square footage is taken as a measure of the size of the boat, then for the balam, the time for completion of the finished boat represents 10.2 manhours/sq.ft. of hull.

The total cost of materials for the Balam was about 68,000 Taka (ex engine) or 84.9 Taka\*/sq.ft. of hull

The total cost of ferrocement materials (extracted from table J2) for the hull and deck was 49,800.00 taka or 33 Taka per sq.ft. of ferrocement surface (including frames, stiffeners, bulkheads, deck beams, etc. The cost of ferrocement materials/sq.ft. of hull was 62.2 Taka/sq.ft. of hull.

## Cox's Bazar Boat

The prototype Cox's Bazar boat was not completely finished and launched by the end of the project; however, the ferrocement hull was completed. The hull surface area was 604 sq.ft.

The prototype boat built by new trainees took 5576.5 manhours. If the same factor can be applied to these hours as experience has shown for the Balam (i.e. a 26% reduction can be expected), then the estimated manhours to complete the ferrocement portion of the hull could be 4127 manhours or 6.83 manhours/sq.ft. of hull.

The material costs to complete the hull were 21810.55 Taka or 36.10 Taka/sq.ft. of hull.

## Chandi Noaki

The breakdown of costs and times for the prototype Chandi have not been included in this report as the final cost was far in excess of that which would be economically viable for this boat.

## Jele Noaki

The Jele Noaki is an unframed, open, small boat without engine or superstructure. The hull contains 190 sq.ft. of ferrocement.

The prototype vessel required 1514 manhours to complete the ferrocement work and 1900 manhours to finish the boat. As new trainees did the work, it can be assumed that, with experience, these figures would be reduced in proportion to the reduction for the Balam (i.e. 26%).

---

\*1 Taka is approximately \$0.127

Therefore, the estimated manhour times for the Jele Noaki would be 1120 and 1406 manhours respectively. The unit times would be 5.9 and 7.4 manhours/sq.ft. of hull.

For the simpler country boat, future design estimates can be derived with a figure of 7.4 manhours/sq.ft. of hull.

The cost breakdown for the Jele Noaki mold is given in Table J4 and the construction times and material costs for the boat in Table J5.

### Grain Storage Silo

The cost breakdown for the silo is given in Table J6. More complete detail will be found in reference (4).

### Water Tank

The water tank costs are shown in Table J7 and compared with the boat costs in Table G8.

### Discussion of Prototype Costs

The remarks of this section are made with reference to Table J8. There are two basic types of prototype boats. A mechanized sea and coastal fishing boat with superstructure, insulated fish hold and deck, as typified by the Balam as the first type. The second type is an open, non-mechanized river country craft such as the Jele Noaki.

The Cox's Bazar boat is in the same category as a Balam and its finished costs, if decked (which is not always the case), would have approximately the same unit costs as the Balam. The difference in ferrocement costs between the two boats is due to the lack of ferrocement deck in the prototype Cox's Bazar boat.

The Chandi Noaki was built in the same fashion as a Balam, even though it is a boat in the Jele Noaki category. It was the first vessel of the type built and comparison of ferrocement costs with the Cox's Bazar type is unfavourable for a framed vessel (it was partially decked) and way in excess of the unit cost of the Jele Noaki. The Chandi is considerably larger than the Jele Noaki but with appropriate handling equipment, it could be fabricated in the same fashion.

The comparison of prices for the boats against their wooden counterparts is difficult as few wooden vessels are being built at current material prices and availability. The prices available to the writer are out of date and fragmentary. An earlier analysis (1) indicated that ferrocement boats were more than competitive with wooden boats made of good timber (jarul, shal, teak). These timbers are no longer available in boat building quantities and to the best of the writer's knowledge, very few boats are made from such wood today. Vessels built of distinctly inferior woods can be cheaper on initial cost. The estimated cost of a wooden Jele Noaki in June, 1974, based upon prices of 1973 was 5600 Taka compared with a ferrocement cost in the prototype of 7794 Taka. The material costs were approximately the same with the major difference in price due to the higher labour cost of the prototype.

With engines, the BJMSS-managed boatyard anticipated little difficulty maintaining competitiveness with wooden boats of the Balam type at an asking price in ferrocement complete in excess of 110,000 Taka per boat.

The Grain Storage Silo was built as an exercise for the yard and to experiment with other applications and materials. There is no equivalent competitor in the Bangladesh market to form a basis for comparison.

The water tank clearly demonstrates the competitive edge that ferro-cement has over steel sheet. The market price for a 400 gallon 18 ga. G.I. sheet tank in April, 1975, was 3200 Taka, more than double the cost of the ferro-cement prototype. Even with a generous allowance for overhead and profit, the ferro-cement tank in production should be very competitive.

## PROTOTYPE PERFORMANCE

### Balam

Up to the end of the project, five Balams had been launched and the first one had been tentatively licensed to operate by the marine authorities. As the material was new to Bangladesh, the licensing authority moved very cautiously before granting a license for subsequent boats.

The first few Balams had a number of problems, as is normal for prototypes. Although none of them were planned, they did provide valuable training for the boatyard personnel. As each problem presented itself, it was rectified by a change in technique or, if necessary, a design change for subsequent boats. Two examples will illustrate the type of problem encountered and the solution.

In Balam I, it was emphasized that for a properly plastered hull, there must be no exposed mesh. On the other hand, the inspection of the plastering by the foreman must ensure that the workmen do not build up an excessive layer of mortar on the outside or inside of the hull over the mesh. The result was that, although the mesh was adequately covered, the buildup of excess mortar made the boat heavier than design. On Balam II, the urge to lighten the boat resulted in large areas of exposed mesh. Both plasterings were good examples of the extreme range within which the plasterers must work. The first is heavy and the second is unsightly with large areas of rusting mesh. The long-term effect of the rusting outer layer of mesh (one of six layers) is not known, but it will undoubtedly effect the life of the boat to some degree. By the fourth boat, the quality of plastering was high and completely acceptable, with the point made that quality control during plastering had to be stringent.

The second example involves the design of the keel. In wooden construction in Bangladesh, the keel, if any, is internal to the hull and the first ferro-cement Balam was designed this way. After launching, and during outfitting, the vessel was brought up and down twice a day on its hull against the concrete slipway. Logs, coconuts, etc., on a couple of occasions came between the hull and slipway. The result of the point loads was a locally damaged hull. The design was modified for subsequent Balams to provide an exterior keel but the damage nevertheless gave the boatyard valuable experience and took the mystery out of the repair of ferro-cement.

The fleet of Balams have not had significant sea time so little can be said at this point of their potential longevity. Balam I has been rented to a primary cooperative down the coast from Chittagong and the operators express satisfaction with its performance, although they have suggested alterations that could make the vessel more useful for fish carrying.

None of the other designs have seen service as yet.

### Silo/Water Tank

Both the silo and water tank have been proof-tested by filling to capacity with water. Some small voids were found and filled in the silo. Both would appear to be satisfactory.



## TRAINING

### Technical Training

The BJMSS designated one of their junior officers, Mr. Fazle Akbar, to be trained in ferrocement boat building during Phase III in order that he might take over the technical management of the yard during Phase IV and thereafter. For the first six months he was treated as one of the workmen with no special privileges or responsibilities. This was a trying experience for the officer for he was required to work manually. In January, 1974, he was designated a foreman and given more and more responsibility until the technical management of the boatyard was turned over to him in June, 1974.

By June, Akbar had been trained in alternate methods of boat construction, he was made responsible for the construction of the bamboo reinforced grain storage silo, he was experienced in the repair of the material and he had handled the workmen to the satisfaction of the project manager. The BJMSS was naturally interested in lessening any dependence on foreign experts in the future of the boatyard, so they requested the project to train their designated trainee in fishing boat design. The man they chose was Akbar and as he was fully occupied during Phase III in the practical aspects of ferrocement construction, it was decided that he would be given as much training as possible during Phase IV of the project.

In addition to his duties as technical manager of the boatyard, Akbar spent considerable time learning to loft, draw lines and do elementary displacement, stability and weight calculations. It was decided that Akbar should integrate the experience of the first Balam design and take on the responsibility of a redesign under the guidance of the project manager. He successfully drew lines plan and lofted the design with very little assistance and he is presently supervising the construction of the first prototype.

### Workmen

The work crews chosen for training comprised two main groups; unskilled young men usually with some secondary and high education and artisans in an allied field. Examples in the second category included former wooden boat builders, carpenters, plasterers and welders. Both groups ultimately provided some excellent ferrocement boatbuilders. Altogether, approximately 45 men were exposed to ferrocement boat building during the course of the project.

The training was entirely on the job. Each workman was required to try his hand at each skill required, but ultimately, men were assigned to the jobs that they were either most interested in or which they did best. While most of the trainees treated the experience as just another job and learned and did as little as possible, about ten were highly motivated, eager workmen. In most cases, these "graduated" to the more highly skilled jobs such as lofting, mold making and frame set up and fairing. In general, the workmen with previous trades were the least motivated.

The pay for the trainees was set, to conform with BJMSS practice, at 350 Taka/month in July of 1973. With the cost of living in Bangladesh, this was barely a living wage although a typical one. The workmen were in general poor health and had little stamina for any hard sustained work such as plastering. As a consequence, the project was forced to adopt certain construction procedures in ferrocement specifically for use in Bangladesh.

With proper salaries and treatment, the workers would be as good as any in the world and the writer experienced little difficulty in transmitting the basic technology.

## Quality of Workmanship

In a pilot project of this kind, it should be expected that the quality of the work would improve with time and this proved to be the case. It was gratifying to see improvements in quality continue during Phase IV in the absence of the project advisor.

It should be pointed out that although the boats of Bangladesh are aesthetically pleasing to look at from the point of view of shape and function, very little effort is expended in quality of workmanship beyond that required for adequate function. Paint is expensive, the quality of available wood is poor and the general level of workmanship is not high.

It was difficult to instill a pride of workmanship in the ferrocement boat building trainees and even with the wooden boat builders there was not a good eye or a concern for fairness of line or shape. As supervision and the skill of the trainees improved, the fairness improved as well, although, it will never develop to "yacht" standard (which upsets some visitors) as the motivation of all concerned is to build strictly for function.

The quality of welding and the quality of plastering both required mistakes to be made before the message was driven home that a minimum standard had to be maintained. In the case of welding, the point was made when a skeg failed on Balam I on its first fishing trip and the rudder was lost. The plastering situation was discussed earlier. There is little doubt that the boatyard will try to cut corners in the future and mistakes will occur; however, they are fully capable of learning from these mistakes.

## Management

During Phase III, the boatyard was under the control of the writer with a Bengali office manager to expedite the administrative functioning of the project. On the construction side initially there was an expatriate ferrocement boatbuilder as yard foreman and under him the potential Bengali technical manager, Fazle Akbar, as a trainee along with the other trainees. After six months, Akbar was made an independent foreman and given responsibility for some of the yard activities.

The BJMSS were asked to participate in the management of the boatyard and they were kept fully informed as to the boatyard activities. During Phase III, however, they were quite content to adopt a passive role and made little effort to prepare for the time when the boatyard would be theirs.

It was, and is, the opinion of the writer that the boatyard could not be run effectively in the long run by just the technical manager. As a condition of the turnover of the assets to BJMSS control and the further involvement of CHF in Phase IV, it was decided that BJMSS would appoint a suitable boatyard manager (at CHF\* expense for the following year) to assume control of the boatyard. He could then gain experience while the writer was still available for advice. Unfortunately, BJMSS do not recognize the necessity of appropriate management of the yard as they withdrew the manager as soon as Phase IV was finished.

The situation now is that the technical manager of the yard is now responsible for boat design, construction, the workmen, any planning for the future, negotiation with senior management and all of the day to day administration of the boatyard. As he is a junior officer of the Society, he is poorly paid and has little influence. He has little or no time to plan for the future and if he were to leave, the pilot facility structure could collapse as the society have made little provision for the development of alternatives.

The problems of middle level local management would not appear to be special to this project, but rather reflect the state of affairs within the country.

---

\* Canadian Hunger Foundation

## FUTURE FOR THE PILOT PROJECT

### Yard Capacity

When this project was initiated, it was assumed that it would continue for some time as a small facility capable of building ferrocement boats of one or two designs. The BJMSS donated a small piece of land to the project and a facility was designed to utilize that land. There was a small parcel adjacent to the one given which was slated for expansion of an existing iceplant of the Society. As the project gained momentum in Phase III, the work-space soon expanded to include all of the free space available.

Two allweather boatbuilding stations are located under the factory shed and it has proved possible but crowded to build four boats in the space in front of the original yard under "kutcha" shelters. Therefore, the boatyard has a capacity to build six boats at a time. If the Balam is taken as an example, with a workforce of 30 men and an average of 8,000 manhours per Balam, approximately 7.5 Balams could be built per year.

With the Jele Noaki at 1900 manhours, approximately 32 could be fabricated. If the yard was converted to the manufacture of water tanks, approximately 170 could be built per year using prototype manhour figures.

### Prognosis for the Future

The project over the course of two years of active expatriate involvement in Bangladesh provided the BJMSS with a nucleus of trained personnel skilled in the manufacture of ferrocement boats in four designs by several different techniques. In addition, a complete inventory of necessary tools and equipment was provided. At the end of Phase IV, the boatyard was actively building boats with ever-increasing skill and efficiency. From the point of view of the aims and objectives of the original project, the project has been successful and a small ferrocement boatbuilding facility is a fact in Bangladesh.

The key to the future of the boatyard lies with the BJMSS management of its affairs. The boatyard could fail in the future for any one of the following reasons:

- i) Inadequate supervision of quality and cost so as to make boat production non-competitive.
- ii) Failure to provide engines for the mechanized boats to the boatyard.
- iii) The loss of one or two key personnel trained in the boatyard in whom the BJMSS have placed all of their confidence.
- iv) Future non-availability of essential materials and spares for equipment, particularly those which require foreign exchange.
- v) Psychological future non-acceptance of ferrocement as a result of a disaster which could be quite unrelated to ferrocement as a material. On the other hand, inadequate supervision and inspection of vessels during and after construction and lack of training of vessel operators to insure that damages are repaired could result in a ferrocement related disaster.

To repeat, the key to the successful future of the boatyard rests in the management and supervision sphere, as the technical skills are available. Some outside help in the form of foreign exchange might be required.

It is encouraging to note that the BJMSS have asked for the basis on which they could develop a large-scale facility, so they clearly perceive the need for alternatives to wooden boat construction.

When this project was first proposed, it was established that most projects of the type around the world had little or no follow-up after the implementation phase. It was recognized then and it is still considered very important that the project continues to be of interest to the Canadian Hunger Foundation and their donors. Firstly, there should be an evaluation of the progress of the boatyard and the service experience and condition of the prototype boats after a suitable interval of time. It is suggested that Spring, 1975, at the end of the winter fishing season, would be appropriate.

Secondly, the boatyard can probably benefit from some external assistance in the form of essential spares and replacements to equipment which involve foreign exchange. A more lasting solution to the problem of vibrator replacement is one example and the Manager has requested certain additional materials which he cannot import.

Thirdly, there could be considerable benefit to the boatyard if some consultancy was available to them if particular technical problems arose. In addition, the final design of the Manager for the Balam III should be evaluated as this vessel prototype was fabricated after the completion of the project.

## REFERENCES

1. Bigg, G.W. "Ferro-cement Boats for Bangladesh, Phase III, Final Report" to Canadian Hunger Foundation, July, 1974.
2. ----- "Ferrocement : Applications in Developing Countries", National Academy of Sciences, Washington, D.C., February, 1973.
3. Badruddoza, K.M. Private communication, February, 1975. Director of Agriculture (Research and Education), Government of Bangladesh.
4. Bigg, G.W. "Bamboo Reinforced Ferrocement Grain Storage Silo", Indian Journal of Structural Engineering, Vol. 2, No. 4, January, 1975, pp 173-182.
5. Smith, R.B.L, et al, "Hermetic Storage of Rice for Thai Farmers", Thai J. Agr. Sci. 4, July, 1971, pp 143-155.

TABLE J1  
 PROTOTYPE DESIGN SUMMARY

<u>PROTOTYPE</u>	<u>BALAM</u>	<u>COXS BAZAR</u>	<u>CHANDI</u>	<u>JELE NAOKI</u>
LOA	44'	38'	42'	35'
LWL	42'	36'	36'	21'
B	12'	10' - 6"	9' - 2"	6' - 6"
D	5' - 0"	4' - 8"	3' - 1"	2' - 0"
Lightship displ. (Tons S.W.)	11.4	6.0	4.6	1.0
Lightship draft	2' - 1"	1' - 8"	1' - 3"	0 - 10"
Full load displ. (Tons S.W.)	24.5	17	13.1	2.5
Net Capacity (Tons S.W.)	13.1	11.0	8.5	1.5
TPI (Tons/in.)	0.83	0.63	0.63	0.23
$C_B$	0.56	0.485	0.566	0.453
$C_p$	0.66	0.599	0.674	0.39

**TABLE J2**  
**BALAM BOAT COSTS**

**Manhours****Hull & Deck**

1.	Steel straightening	140.0	
2.	Frame fabrication	93.0	
3.	Deck beam fabrication	43.3	
4.	Steel addons	229.7	
5.	Frame set up	517.1	
6.	Mesh application	1,211.0	
7.	Hull rods	373.0	
8.	Tying and fairing	1,163.0	
9.	Plastering & curing	1,274.6	
10.	Miscellaneous time	<u>137.0</u>	
		5,181.7 @ 2Tk/manhour	10,363.40 Taka

**Outfitting**

11.	Sheer cap and collision rail	360.3	
12.	Wooden hatch coamings	139.0	
13.	Superstructure	717.3	
14.	Rudder & Steering installation	92.3	
15.	Engine installation	199.5	
16.	Fish hold	211.5	
17.	Painting	266.7	
18.	Miscellaneous	<u>1,001.0</u>	
		2,987.6 @ 2Tk/manhour	<u>5,975.20 Taka</u>

Total labor cost:           16,338.60 Taka

TABLE J2 (Continued)

**Materials**

1.	3/8" M.S. Rod	3595 rft @ 1.18 Tk/rft	4,242.10
2.	1/4" H.D. Rod	6867 rft @ 0.35 Tk/rft	2,403.45
3.	1/2" Hex Mesh 20 ga	12565 sq ft @ 1.95 Tk/sq ft	31,147.30
4.	1/4" 20 ga sq woven mesh	2666 sq ft @ 2.50 Tk/sq ft	6,665.00
5.	Tie wire — 20 ga	76 seers (167.5 lb) @ 15 Tk/seer	1,140.00
6.	Cement (50 kg)	67 bags @ 40 Tk/bag	2,680.00
7.	Sand	97.7 cft @ 1.20 Tk/cft	116.04
8.	Fastenings	55 seers @ 11 Tk/seer	605.00
9.	Electrodes	1234 rft @ 1.14 Tk/rft	1,406.76
10.	Coal tar	36.3 seers @ 11 Tk/seer	399.30
11.	Wood	118.5 cft @ Tk/cft	5,332.50
12.	Tin sheet	6 std sheets @ 85.57/sheet	513.42
13.	Engine installation		954.20
14.	Rudder & Steering gear		<u>1,074.00</u>
			58,679.07 Taka

**Insulated fish hold**

15.	Tin liner	44 pcs @ 85.57 Tk/pc	3,765.08
16.	2" insulation	83.5 pcs	3,000.00
17.	2½" insulation	33 pcs	1,080.00
18.	Wood	24 cuft @ 45 Tk/cft	253.00
19.	Fastenings	23 seers @ 11 Tk/seer	109.65
20.	Coal tar	25.5 seers @ 4.30 Tk/seer	<u>557.65</u>
21.	Miscellaneous materials		
		Material Cost	67,444.45 Taka
		Labor Cost	<u>16,338.60</u>
			<u><u>83,783.05</u></u>

Reference Date June 3, 1974. 1 Taka = 12.7 U.S. cents

Data compiled on the basis of five vessels.



**TABLE J3**  
**COX'S BAZAR BOAT COSTS**

**Manhours****Hull**

1.	Steel straightening	302
2.	Frame fabrication	110
3.	Frame set up including keel box, stern	521
4.	Steel addons	457.5
5.	Hull rods	340
6.	Mesh applications	1,386.5
7.	Tying and fairing	907.5
8.	Plastering	390.5
9.	Curing	628
10.	Miscellaneous time	<u>533.5</u>
		5,576.5 manhours

Estimated manhours when in production  $5,576.5 \times 0.72 = 4,015.1$  @  
2 Tk/manhour 8,030.20 Taka

**Materials**

1.	3/8 M.S. Rod	2369 rft @ 1.18 Tk/rft	2,795.42
2.	1/4 HD rod	5838 rft @ 0.35 Tk/rft	2,043.30
3.	1/2 hex mesh 20 ga	5645 sq ft @ 1.95 Tk/sq. ft.	11,007.75
4.	1/4" sq. woven	900 sq ft @ 2.5 Tk/sq ft	2,250.00
5.	10-30 ga mesh	300 sq ft @ 2.4 Tk/sq ft	720.00
6.	20 ga Tie wire	41 srs @ 13 Tk/seer	533.00
7.	Cement (50 kg)	43 bags @ Tk/bag	1,720.00
8.	Sand	81 cft @ 1.41 Tk/cft	114.21
9.	Fastenings	1/2 seer @ 11 Tk/seer	5.50
10.	Electrodes	720.5 rft @ 1.14 Tk/rft	<u>621.37</u>
		Total material cost	21,810.55 Taka
		Total labor cost	<u>8,030.20</u>
		<b>TOTAL TO COMPLETION OF HULL</b>	<b>29,840.75 Taka</b>

These costs are to the completion of the ferro-cement portion of the hull.

TABLE J4

## JELE NOAKI MOLD COSTS

## Manhours

1.	Lofting	66.0
2.	Male mold fabrication	646.5
3.	Construction shelter	65.0
4.	Factory maintenance	<u>84.5</u>

862.0 manhours

@ 2 Taka/manhr. = ,1,724 Taka

## Materials

1.	4-4x8 sheets—fibre board	@ 24 Tk/sheet	96.00
2.	1 — Gallon paint	@ 200 Tk/gal	200.00
3.	721 ft — 1/4" M.S. rod	@ 0.35 Tk/ft.	252.35
4.	482 ft — 3/8" M.S. rod	@ 1.18 Tk/ft.	568.76
5.	8.5 seers — 20 ga Tie wire	@ 13 Tk/seer	110.50
6.	160 lbs. — Misc. support steel	@ 4.25 Tk/lb.	680.00
7.	190 rft — Welding electrodes	@ 1.14 Tk/rft	216.60
8.	1 3/4 seer — lashing rope	@ 7 Tk/seer	12.25
9.	5 seers — common nails	@ 11 Tk/seer	55.00
10.	12.2 cft — Wood (various sizes)	@ 70 Tk/cft	854.00
11.	2 pcs — Large bamboos	@ 15 Tk/pc	30.00
12.	100 pcs — small bamboos	@ 8 Tk/pc	180.00
13.	200 bundles of Sun-grass	@ 1 Tk/bundle	<u>200.00</u>

3,455.46 Taka

Total Jele Noaki Mold Costs 5,179.46 Taka

Assume that it is good for 20 boats : 260 Taka/boat

**TABLE J5**  
**JELE NAOKI COSTS**

**Manhours**

1.	Misc. steel rod fabrication	54.5
2.	Wooden batten core	108.0
3.	Mesh application	345.0
4.	Final tying and fairing	359.0
5.	Plastering	270.5
6.	Curing	376.5
7.	Mold removal & boat turning	88.5
8.	Collision and shear rail	202.50
9.	Additional wooden finishings	63.0
10.	Painting	31.0
		<u>1,898.50</u>

@ 2 Tk/manhour/

3,795.00 Taka

**Materials**

1.	116 ft. — 1/4" MS rod	@ 0.35 Tk/ft	40.60
2.	90 ft. — 3/8" MS rod	@ 1.18 Tk/ft	106.20
3.	835 sq ft — 1/2" 20 ga hexagonal mesh	@ 1.95 Tk/sq ft	1,628.25
4.	100 sq ft — 10 # mesh	@ 2.4 Tk/sq ft	240.00
5.	17.5 srs — 20 ga Tie wire	@ 13 Tk/seer	227.50
6.	20 rft — welding electrodes	@ 1.14 Tk/rft	22.80
7.	17.53 cft wood	@ 45 Tk/cft	788.85
8.	15 bags — cement (50 kg bags)	@ 40 Tk/bag	600.00
9.	17 cuft — Sand	@ 1.41 Tk/cft	28.97
10.	12 seers — boat nails	@ 5 Tk/seer	60.00
11.	3.25 seer — common nails	@ 11 Tk/seer	35.75
12.	5 gals — coal tar	@ 40 Tk/gal	200.00
13.	2.5 gals — paint	@ 300 Tk/gal	<u>750.00</u>
	Total material cost		4,723.92 Taka
	Labor		3,795.00
	Mold		<u>260.00</u>
	Total prototype cost		8,778.92 Taka

If the labor cost is scaled by 26 percent on the total prototype cost, the projected cost would be 7724 Taka.

TABLE J6  
GRAIN STORAGE SILO COSTS

**Manhours**

1.	Steel straightening	26
2.	Preparation of bamboo	166
3.	Sieving, drying sand	20
4.	Fabrication of top and lid	73
5.	Fabrication of base	348
6.	Fabrication of cone	437
7.	Miscellaneous	4
		<hr/>
		1,074 manhours

**Materials**

1.	1/4" M.S. Rod	152 ft @ 0.39 Tk/ft	60.00
2.	3/8" M.S. Rod	521 ft @ 0.87 Tk/ft	453.00
3.	1/2" - 20 ga Hex	1663 sq ft @ 1.20 Tk/sq ft	1,996.00
4.	Bamboo	24 large @ 10.5 Tk/bamboo	245.00
5.	Tie wire	56 lbs @ 5 Tk/lb	280.00
6.	Welding Rods	91 rft @ 0.24 Tk/rft	22.00
7.	Coal Tar	2 lb @ 5.5 Tk/lb	11.00
8.	Cement	16 bags @ 36 Tk/bag	576.00
9.	Sand	24 cft @ 5 Tk/cft	120.00
			<hr/>
			3,763.00 Taka

**Cost:**

Materials	3,763.00
Mold Cost	180.00
Labor @ 2 Tk	<u>2,148.00</u>
	6,091.00 Taka

Costs referenced to January, 1974

**TABLE J7**  
**400 GALLON WATER TANK**

**Manhours**

1.	Forming steel	62	
2.	Set up of skeleton	27	
3.	Meshing	53.5	
4.	Tying	13	
5.	Plastering	53.5	
6.	Curing	122.0	
7.	Fabrication of top	<u>27.0</u>	
		358.0	@
		2 Tk/hr	

716.00 Taka

**Materials**

1.	1/2" Hex mesh	220 sq ft @ 1.95 Tk/sq ft	429.00
2.	1/4" H.D. rod	327 rft @ 0.35 Tk/rft	114.45
3.	Electrodes	54 rft @ 0.64 Tk/rft	34.56
4.	Tie wire	3/4 srs @ 15 Tk/seer	11.25
5.	Cement	4½ bags @ 40 Tk/bag	180.00
6.	Sand	7½ cuft @ 1.2 Tk/cft	<u>9.00</u>
			778.26 Taka

Labor Cost 716.00

Materials 778.26

Total prototype cost 1,494.26 Taka

TABLE J8  
PROTOTYPE UNIT COSTS

	Hull Area (sq ft.)	Total Cost (Taka)	Manhours per sq. ft. of hull area	Total Material Costs Tk/sq ft	Ferro Cement Costs Tk/sq ft	Total Finished Costs Tk/sq ft
BALAM	801	83783	10.2	84.9	62.2	104.6
COX'S BAZAR	604	29841 f-c hull only	6.83 f-c only	-	36.10	-
CHANDI	394	18628	9.49	26.27	47.28	47.28
JELE NOAKI	190	7794	7.4	24.84	31.14	40.65
SILO	220	6091	4.9	17.19	22.0	27.7
WATER TANK	91	1494	3.93	8.55	16.42	16.42

TABLE J9  
FERRO-CEMENT — WOOD COMPARISON

Boat Type	Wood cft	Wood @ 40 Tk/cft			Wood @ 60 Tk/cft		
		Material	Labor	Total	Material	Labor	Total
Jele Naoki	55	2200	1100	3300	3300	1650	4950
Cox's Bazar	375	15000	5100	20100	22500	7650	30150
Boat Type		Wood @ 120 Tk/cft			Ferro-cement		
		Material	Labor	Total	Material	Labor	Total
Jele Naoki		6600	3300	9900	4724	3070	7794
Cox's Bazar		45000	15750	60750	21811	8030	29841

**Note:** With respect to data gathered during the course of this project, the following factors can be used to estimate the labor and finishing charges as a fraction of the material costs for wooden construction.

Unmechanized boat (Jele Naoki) Labor equals 0.50 material cost

Mechanized boat (Cox's Bazar) Labor equals 0.35 material cost



Figure J1: Balam IV at anchor in the Karnafuli River

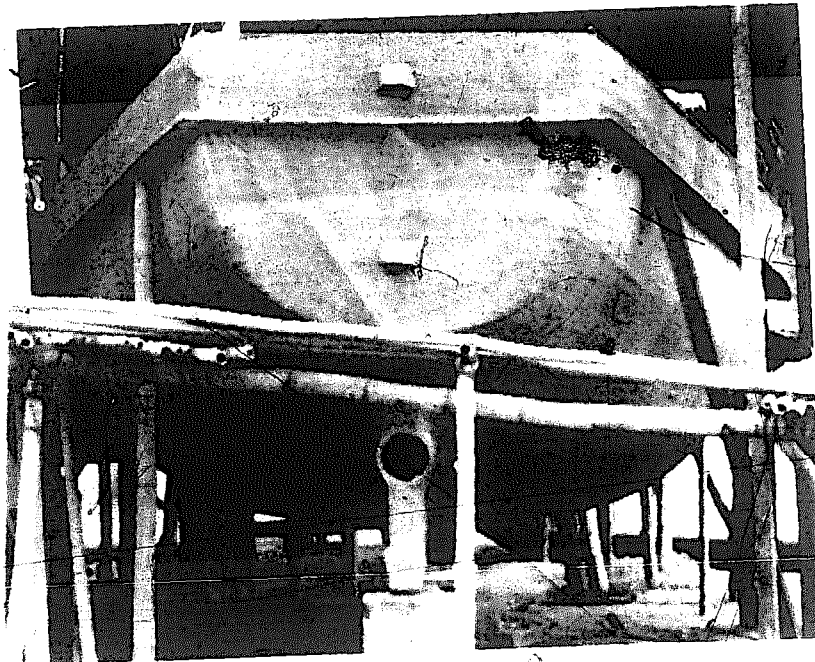


Figure J2: Cox's Bazar Boat, meshing completed, ready for plastering



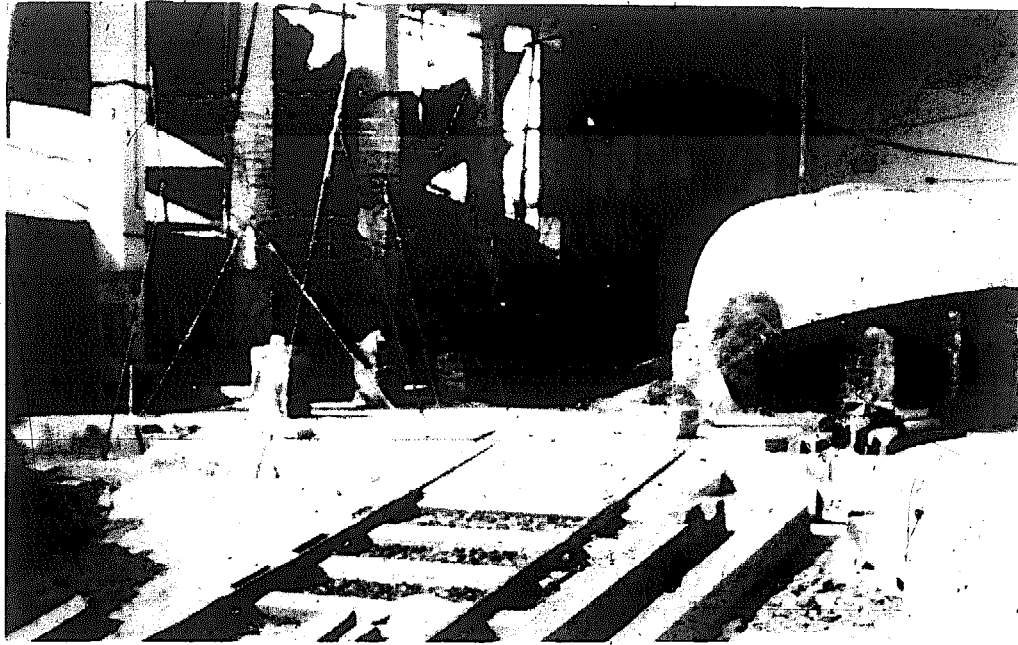


Figure J3: View of the factory shed with the frames for a Balam and the plastered hull of the Chandi



Figure J4: Ferrocement Jele Naoki under construction on its mold. The inner layers of mesh have been applied plus one-half the wooden core battens



Figure J5: Bamboo core application to side of grain storage silo

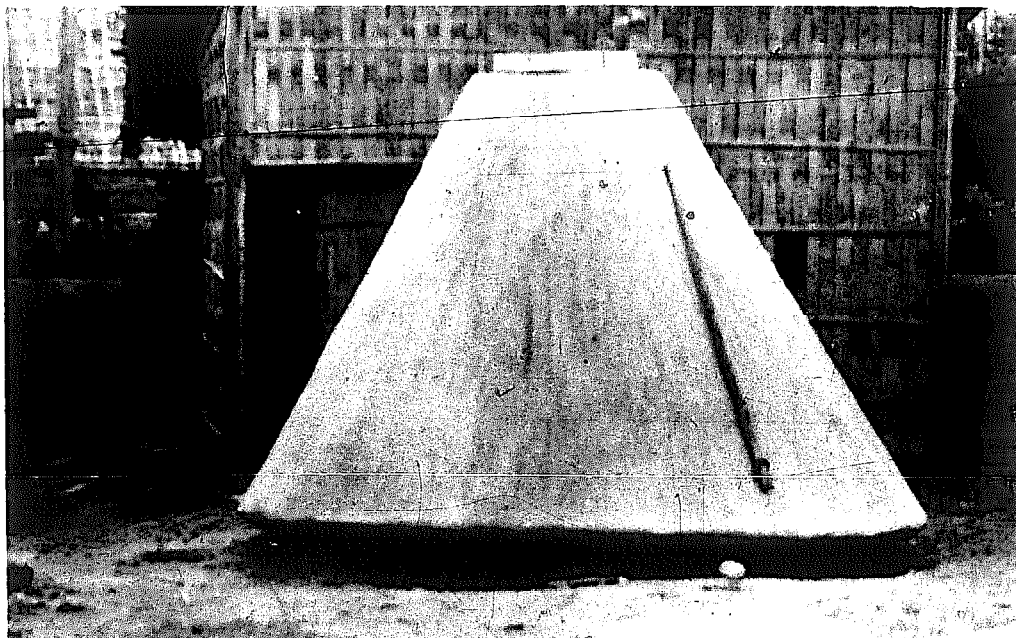


Figure J6: Completed grain storage silo

## APPENDIX K

## WATER JARS OF CEMENT MORTAR\*

by

O. Phromratanapongse

In many parts of the world, water has to be collected daily over long distances using human labor. This involves a great waste of time and labor, and is often unhygienic.

If a cheap and easy method of making containers for storing rain water could be developed and put into widespread use, a great deal would be gained by improved standards of public health and by turning wasted labor to more productive use.

The traditional water jars of burnt clay and cement mortar are not as widely used as one might expect because their production requires skills which are not popularly known.

The following series of photographs describes a cheap and practical method, of marking a 250 litre jar at the cost of about US\$0.50 (the major cost item being the cost of 12 kg. of cements. This method of constructing water jars was developed by the Siam Cement Co., Ltd., in Bangkok.

The cement sand proportion was 1:2 by weight and the water cement ratio was about 0.4.

A piece of wire or wooden stick was used to control the thickness of the wall by piercing it through the fresh mortar.

This method has been taught to a number of people without any previous knowledge in masonry. Most of them learn the technique in one day.

The biggest jar built by this method has a capacity of 3.5 Cu.m., and costs about US\$12.00 (Figure K 12).

In conclusion, the method described requires a very low level of technology and can easily be adapted by practically anyone. Its low cost is also attractive to people with low income.

---

\*This jar described in this Appendix has no reinforcing mesh and is not strictly ferro-cement. Nevertheless it is an extension of ferro-cement technology and is included here because of its importance and because it was first reported at the Workshop.

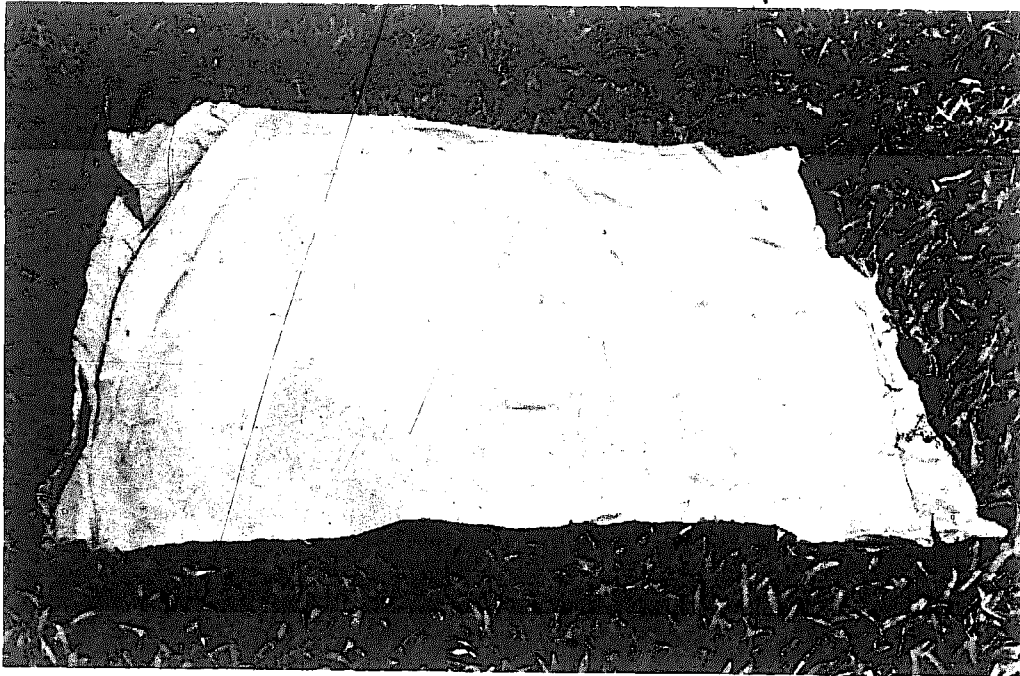


Figure K1: Two pieces of gunny cloth 125 x 112 cm. are used. One piece is laid on top of the other and sewed along the curved lines at the two sides (see Figure K.11) leaving the top and bottom open



Figure K2: The sacks are turned inside out after sewing

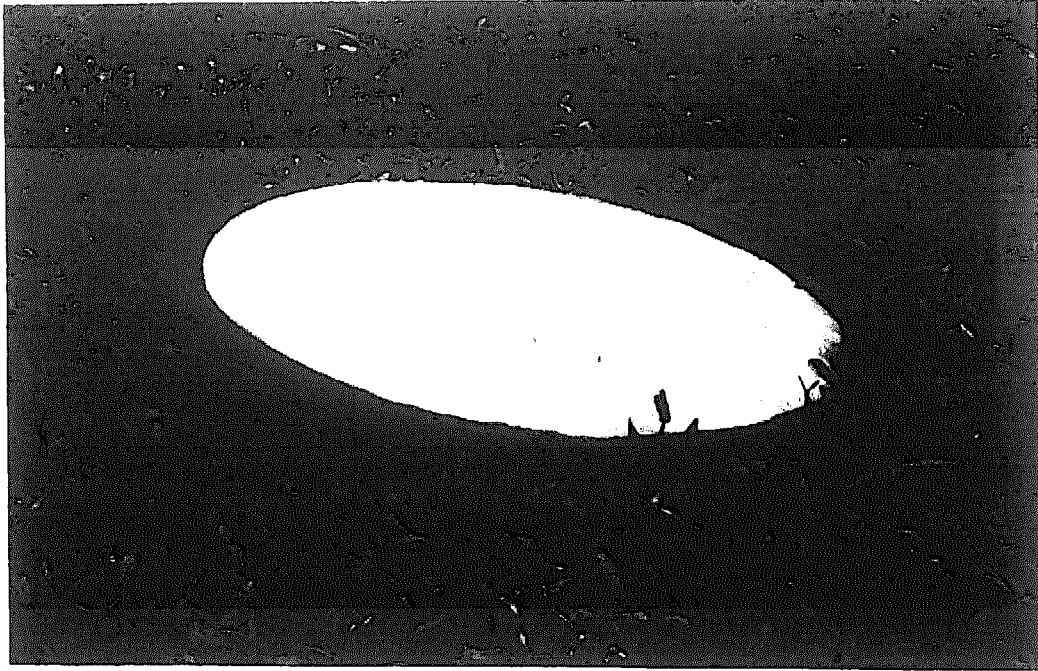


Figure K3: Precast bottom plate 58 cm. in diameter and 1.5 cm. thick



Figure K4: The sack is placed on the bottom plate and the space filled with paddy husk, saw-dust or sand. The weight of the fill will hold the lower edge of the sack firmly on the bottom plate

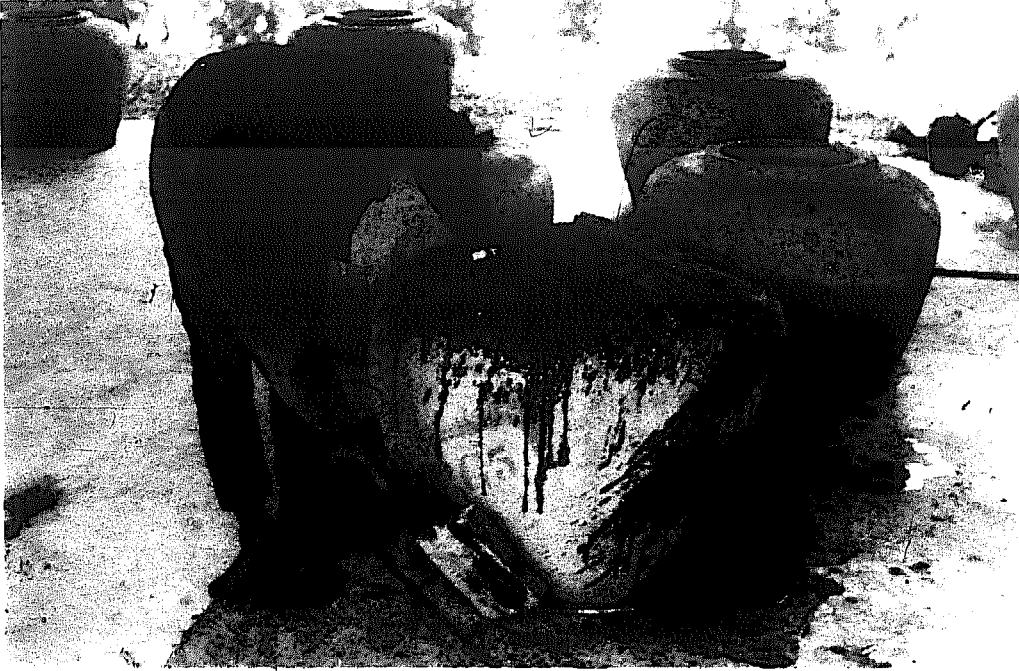


Figure K5: The upper part of the sack is folded to the shape of the traditional water jar. A piece of wood is used for tapping the mould to obtain a smooth surface

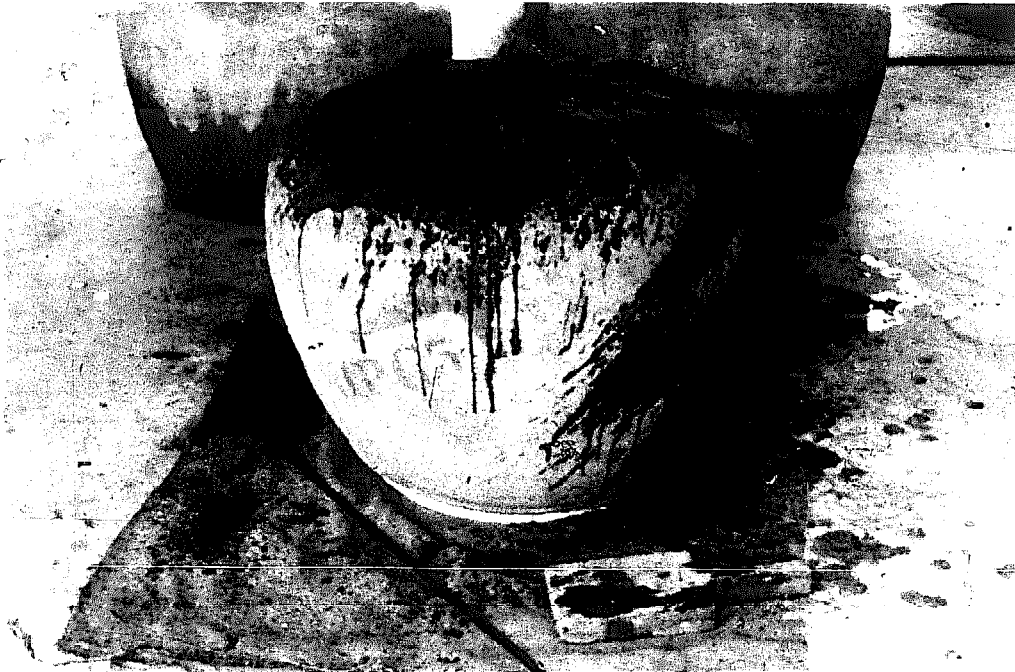


Figure K6: Water is sprayed on the mould before plastering



Figure K7: A circular object is placed on the top to act as a mould for the opening



Figure K8: The first layer of cement mortar is applied from the bottom to the top with a thickness of about 0.5 cm.

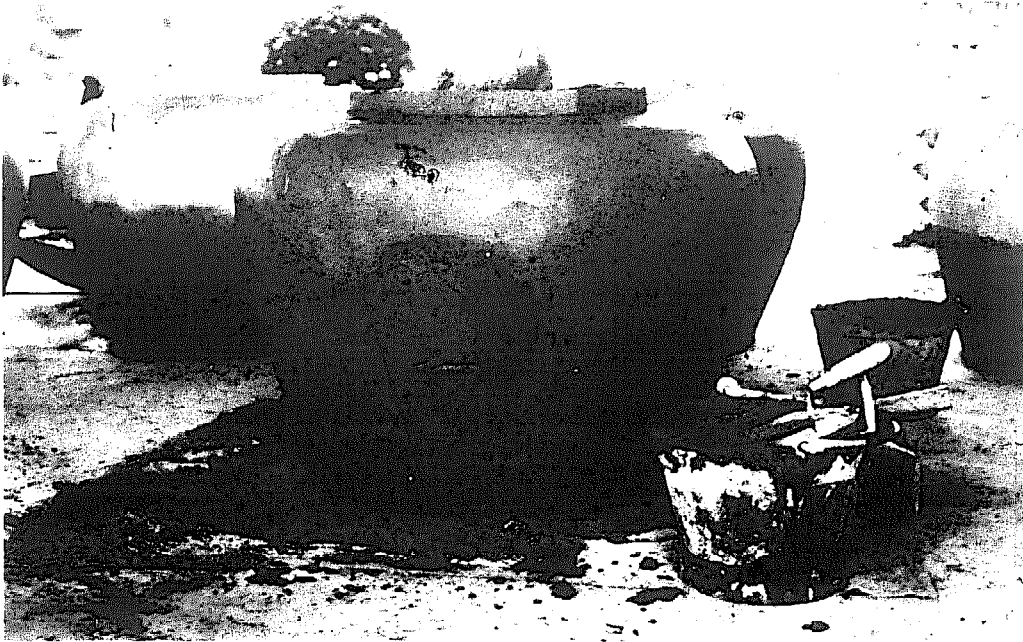


Figure K9: The second layer of cement mortar 0.5 cm. thick is applied

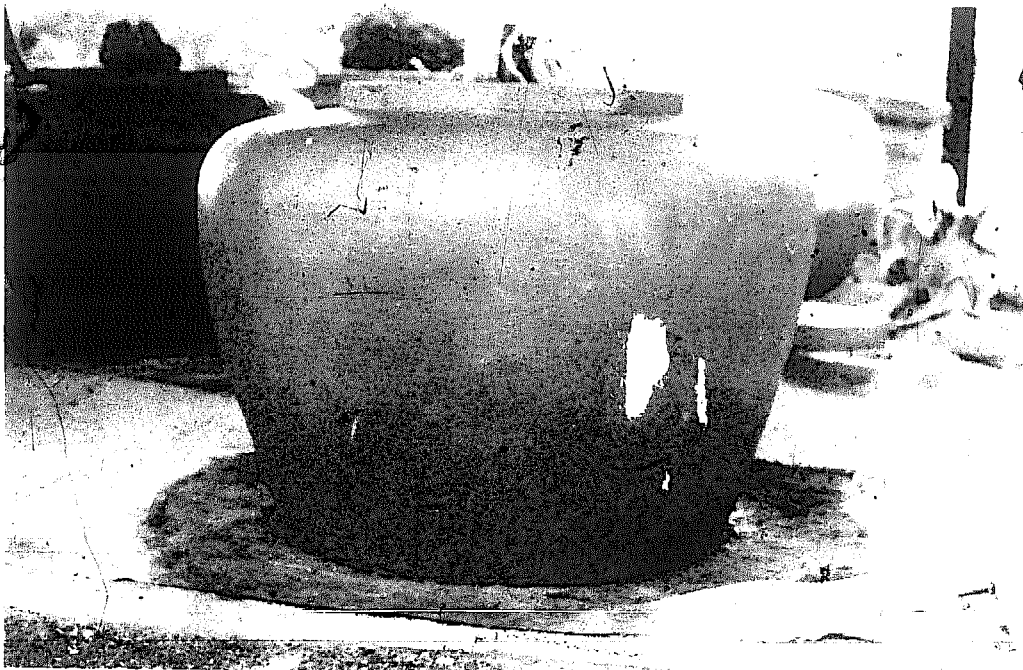
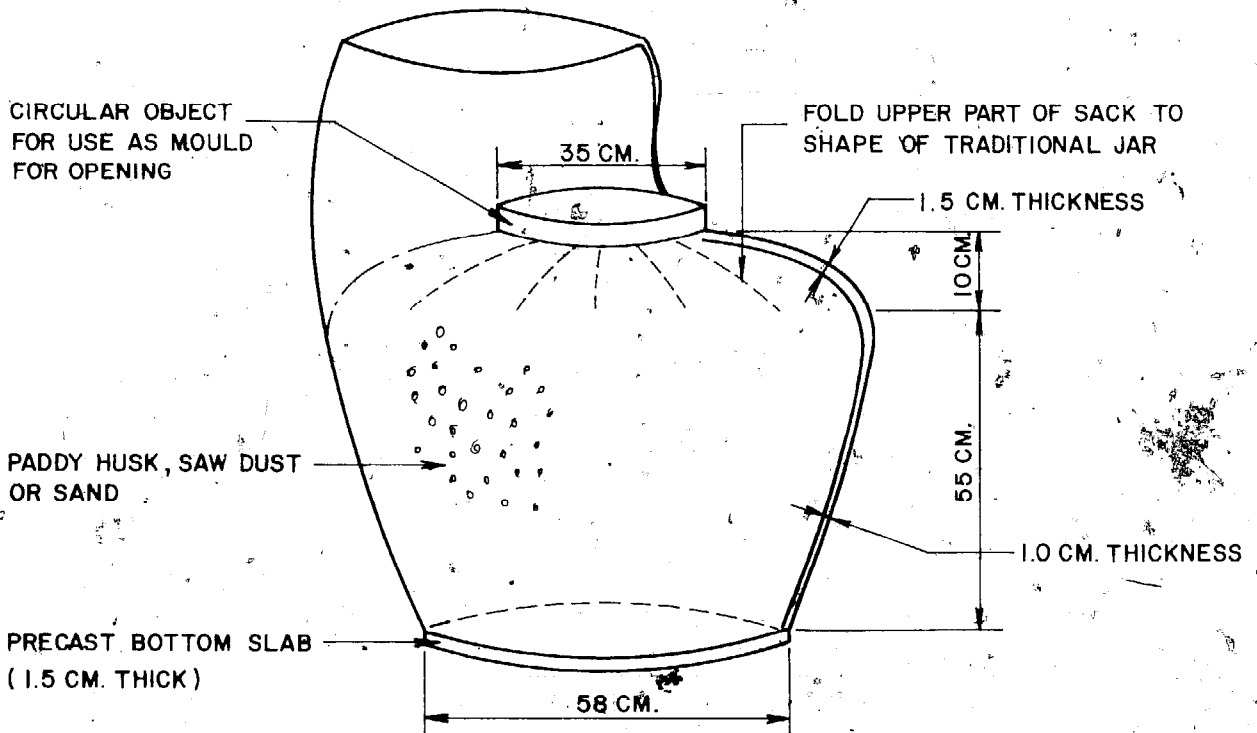
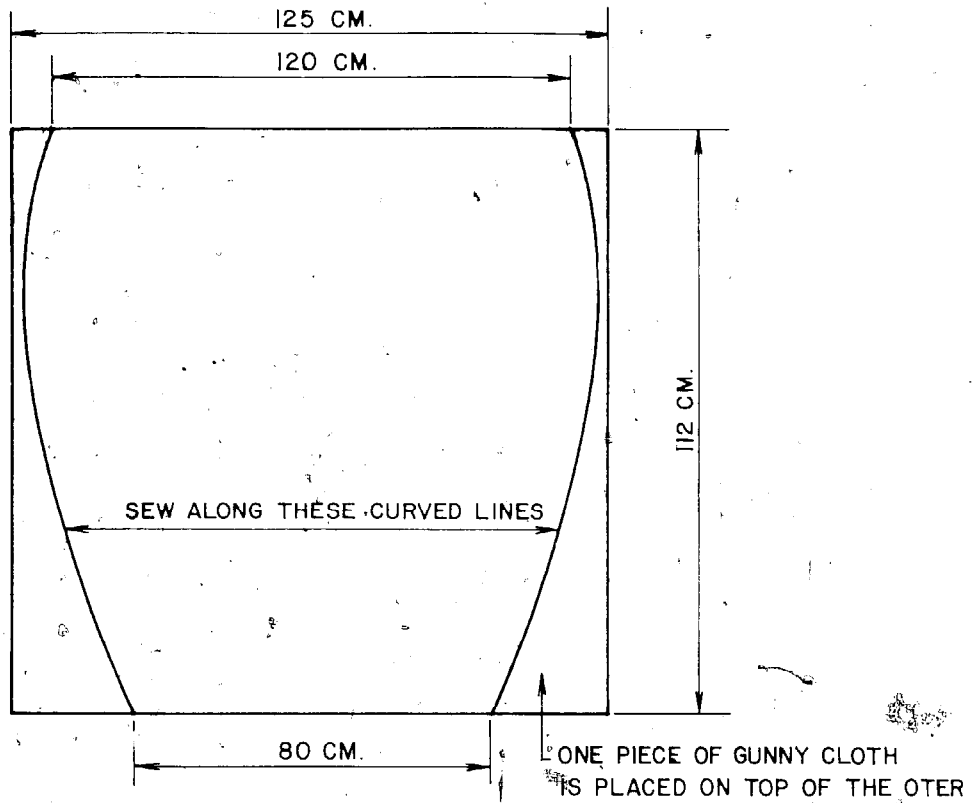


Figure K10: The jar is cured as in ordinary plastering work. The contents of the gunny bag and the bag are removed 24 hours after plastering





102

70%

Figure K11: Gunny cloth pattern for use as mould

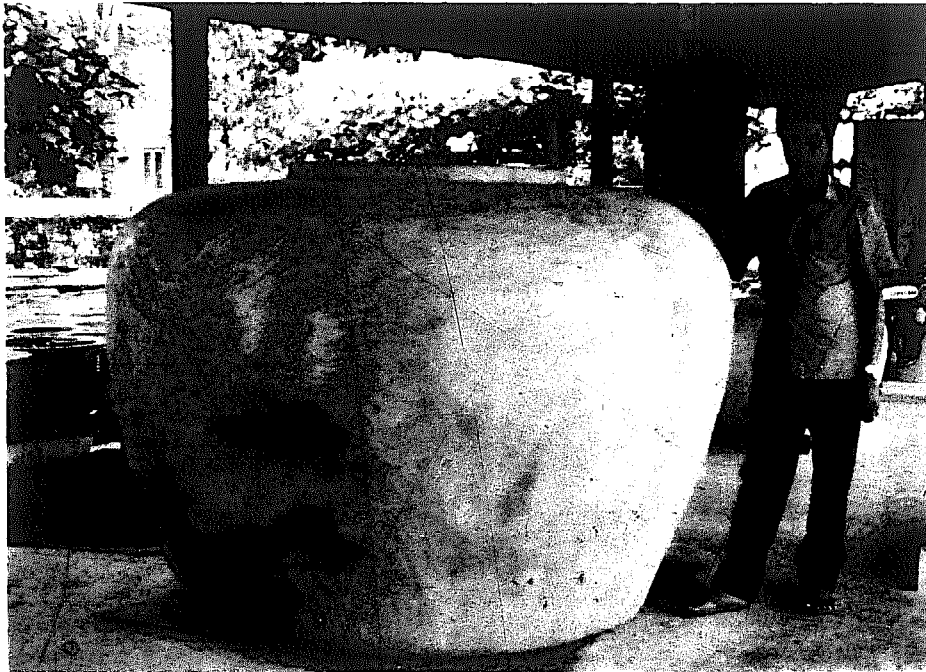


Figure K12: The biggest jar built by this method has a capacity of 3.5 cu.m. and the cost is about US\$12.00

APPENDIX L  
DEVELOPMENT AND APPLICATION OF FERROCEMENT  
IN SRI LANKA AND MALAYSIA

by

A.N.S. Kulasinghe

Our work on Ferrocement had two basic aims. The first was an attempt to solve the problem of the shortage of fishing boats in Sri Lanka, and the other was to find substitutes for certain construction materials which so far had been imported at the cost of badly needed foreign exchange.

Sri Lanka is an island having very good fishing grounds within a reasonable distance from its shores but it has not been possible to exploit these resources fully due to the lack of sufficient fishing boats. The boat building industry based on timber has been unable to meet the demand and materials such as fibre glass which can contribute to fast boat building are too expensive and have too high a foreign exchange component to be practicable.

The obvious answer was the use of ferrocement in boat building, as it could contribute to cheaper and more expeditious construction and involved only a small foreign exchange component.

#### Wirecon Process

The establishment of the Research and Development Division of the State Engineering Corporation of Ceylon in 1966 enabled systematic work to be carried out in the investigation of the use of locally available fibres for the manufacture of building materials to replace certain products based on imported asbestos fibre. The suitability of coconut fibre, which is readily available in the country, for the manufacture of cement bonded composites, was investigated as a priority research and development project. This work, while being quite successful, led to the use of steel fibres in the production of composites with higher strengths than could be achieved with vegetable fibres. Various forms of steel fibre were tried out. They included steel wool, swarf from turning operation on mild steel in workshops and fine gauge steel wire available in the market. The latter was the most suitable; the others did not have the necessary strength.

These investigations showed that short pieces of steel wire mixed with cement mortar was very suitable for the manufacture of a number of products, in addition to being quite suitable for the plastering operation in the Ferrocement process. This process was given the name Wirecon by my colleagues who worked with me on the project.

#### Ferrocement Boats

Ferrocement boat building started in 1967 using the Wirecon process and several boats ranging from 28' fishing boats to 48' harbour launches have been built. There were teething troubles at the start but these were overcome and the construction is now on a sound footing.

After investigation of a number of alternative methods of construction including wooden mould, lattice frame and tube frame the latter was selected as the most suitable. The normal techniques used in ferrocement construction have been used, except for the reduction of the wire mesh by about 50% and the use of chopped wire (28 S.W.C. and 1" - 1½" long) mixed with the cement-sand mortar used for plastering the skin. Impact tests on representative panels demonstrated the suitability of this method of construction. It was also possible to reduce the cost as compared to established ferrocement construction. The use of the chopped wire presents no problems once the correct techniques are mastered.

The cost of these boats compared favourably with other forms of construction and in the case of the 48' boat, it was found that the ferrocement boat was about half the cost of a similar boat built of teak. Even considering the use of cheaper timber for construction the ferrocement boats were cheaper and if the cost of the sheathing, which is necessary in the case of timber boats, is considered, the cost difference is even greater.

It is not necessary for me to deal with the advantages of ferrocement construction. It must be emphasised, however, that ferrocement has not been used to the same extent as it should be due to various problems, one being the attempt by incompetent persons to construct ferrocement boats. Even some who claim to have had the necessary experience have demonstrated the fallacy of their claims by poor performance. It has been found that a number of people have claimed to be experts in this field and started the construction of ferrocement boats but due to their lack of experience and know-how such ventures have come to grief. It is, therefore, necessary that this type of construction be handled, other than on an amateur basis, by people who have a thorough knowledge of the material and the method of construction. A knowledge of the elementary principles of naval architecture and marine engineering is quite helpful. This will ensure that ferrocement will get the confidence it deserves.

### Other Ferrocement Products

There are a number of other products in which ferrocement can be used with advantage. One such item is the water tank that is commonly used in houses. At present these tanks are made either of galvanised steel, fibre glass or asbestos cement. It has been found that the use of ferrocement gives a cheaper and more durable water tank than the galvanised tank and the cost advantage when compared to the fibre glass or asbestos cement tank is even greater. The ferrocement tank has the advantage of freedom from corrosion and greater durability in addition to its lower cost, but one of the problems that has arisen is the greater weight, especially those tanks which were built in one complete unit. As a solution to this problem I have been working on the use of precast panels in ferrocement, similar to the pressed steel tanks that are commonly used. This has proved quite successful and the use of ferrocement in Prandtl membrane shells has enabled a panel to be produced, which is both strong and competitive in price. These panels can be transported in the same way as pressed steel panels and assembled in position to form the required size of water tank. Water tanks built with panels constructed in ferrocement are in common use in Sri Lanka and their superiority over galvanised steel tanks has been definitely established. This is specially so in countries where there is a shortage of steel due to a shortage of foreign exchange.

### Ferrocement in Machine Construction

Work was also carried out to investigate the possibility of using ferrocement in the construction of certain items which are normally outside the scope of this material. I refer

to the construction of items of machinery used in the construction industry. In my investigations, I found that there was a distinct possibility of using this material as an alternative to steel in the construction of items of equipment such as cranes. The first item to be constructed was an overhead travelling crane in which ferrocement box girders were substituted for the steel box girders which are normally used. The crane was a 5 ton overhead travelling crane with a span of 50' constructed of ferrocement where the box girders were made in sections and prestressed together. The first crane that was built in this way was exhibited at the exhibition organised in 1970 in connection with my Presidential Address to the Ceylon Association for the Advancement of Science. It was found that the difference in weight between a steel girder and a girder using ferrocement was not sufficient to offset its other advantages. The weight of the ferrocement crane girder was about one and half times that of the equivalent steel girder. Considering the cost of ferrocement per ton against the cost of steel per ton the economy of using this material in place of steel is quite apparent. There are a number of structures for machinery and equipment where weight is not a deciding factor if the cost can be cut down sufficiently. In fact, there are certain items of machinery where the weight itself is an advantage and in these cases the use of ferrocement is of distinct advantage. The use of prestressing along with ferrocement enables several items of machinery and equipment, where only steel has been used so far, to be constructed economically without sacrificing efficiency. A considerable amount of work has been done in the use of concrete for the construction of machinery, including machine tools, and the use of ferrocement combined with prestressing widens the field still further.

### Work in Malaysia

It has been possible for my work in ferrocement to be continued in Malaysia where it has a large potential in view of the rapid development taking place. This applies especially to the development of the fishing industry to exploit the rich resources in the area. Here again, fisheries development is handicapped by the shortage of fishing craft. It has been found difficult to build the necessary boats in timber to meet the demand in view of the time-consuming operations involved. The ferrocement boat is a solution to this problem and the first 52' fishing trawler in ferrocement (using the Wirecon process) is nearing completion.

Work is also in progress for the production of panels to be used in the construction of water tanks ranging from small tanks for houses to large tanks used in industry.

### Further development

There is a vast field in which further work can be done in the use of ferrocement in the construction of various items of equipment that are now made using steel and timber. A large amount of work has already been done in the use of ferrocement in the construction of boats, barges and ships but a further field where it can be used to advantage is in the construction of submarine vessels especially for the transport of bulk cargo. It is generally known that the wave making resistance forms a substantial part of the resistance encountered in the propulsion or towing of craft and if this can be eliminated the total resistance can be reduced. For this purpose submarine vessels can be constructed using

ferrocement quite economically and this is an area where ample scope exists. It has also been found that it is more economical to use towed barges with the use of towing tugs than to use self propelled craft especially when the distances involved are not great. The construction of submarine craft in ferrocement for towing can make a distinct contribution to the lowering of transport costs.

A large area exists in which ferrocement in combination with prestressing can compete with traditional materials of construction especially at a time when the high cost and shortage of steel are creating serious problems.

## APPENDIX M

FERROCEMENT  
DEVELOPMENTS AND APPLICATIONS IN INDIA

by

H.C. Visvesvaraya

**Introduction**

Ferrocement has attracted considerable attention in the past ten years. The economy of ferrocement construction, compared with steel, wood or glass-fibre reinforced plastic depends greatly on the product being built, but ferrocement is in general quite competitive with other construction forms. In many situations, like all other engineering materials or techniques, it has its strong points as well as weaknesses and limitations.

The relatively low unit cost of materials is perhaps the greatest advantage of ferrocement. The labour content varies depending on the technique adopted, the quality control and workmanship envisaged and the unit cost of labour.

**Suitability to Indian conditions**

Although the increased interest in ferrocement for marine and land use is fairly recent, successful examples of innovative applications within a wide range of construction techniques and sophistication, already promise a major impact in modern technology for the following reasons:

- i) Ferrocement can be fabricated into almost any conceivable form to meet the particular requirements of the user. This is particularly pertinent where acceptance of new materials may be dependent on their ability to reproduce traditional designs and/or where advantage can be taken of the shape effect to resist the acting forces.
- ii) The basic raw materials involved — sand, cement and reinforcing mesh — are readily available except in special cases and circumstances.
- iii) Except for highly stressed or critical structures, adequate ferrocement construction does not demand such stringent specifications as would call for only sophisticated supervision and/or skill.
- iv) Very little new training is required for the labourers as the cement mortar construction techniques are widely known in India and the Indian construction workers often show a good aptitude for plastering.
- v) Provided reasonable care is taken in construction, ferrocement needs little maintenance. Only simple tools are required to repair any damage to the mesh and only cement and sand to make fresh mortar.

## Experimental/Developmental Investigations

A large number of experimental/developmental investigations have already been undertaken and are presently in progress at the various Indian Institutes of Technology including Engineering Colleges, Universities and National Research Institutes. Almost all these studies have been essentially aimed at evaluating the mechanical properties of ferrocement with particular reference to the conditions and materials obtaining in India. A good amount of data on the behaviour of ferrocement elements in direct tension, direct compression and flexure are already available from India. Some of these investigations have, however, been extended to the possible and potential fields of application of ferrocement technology through studies carried out on structural models.

A good deal of research and development work is also being carried out by a few National Research Institutes such as the Cement Research Institute of India and the Structural Engineering Research Centre at Roorkee in Uttar Pradesh. These organizations are endeavouring to establish the feasibility of using this material in prefabricated roofing elements, water retaining structures, grain storage structures, and in other suitable elements and components.

## Applications of Ferrocement Technology

A small ferrocement boat was made by the Cement Service Bureau at Madras on an experimental basis in 1970.

As early as 1950, the Indian Railways had introduced ferrocement for building prefabricated 'gunite' houses for the railway staff — as a low cost method of housing. The walls of these houses were of 5 cm 'gunite' shot over shuttering in situ. The reinforcement was a framework of bars and chicken mesh, the vertical bars of the framework acting as column reinforcement. A number of houses have been constructed in Bombay and Delhi apart from other uses such as Railway Compound Walls, etc.

## Ferrocement for Boat Building

In recent years, ferrocement boats have been built and are now operating, among other places, in Australia, Bangladesh, Hong Kong, India, Fiji, Korea, Malaysia, New Zealand, The Peoples Republic China, Singapore, Sri Lanka, Thailand, South Vietnam, and Western Samoa. Boat building applications of ferrocement can contribute to economic development and the general welfare of people in many countries of the world.

There is great scope in India for the development of the fishing industry. Only a tiny fraction of the vast hoard of the Arabian Sea and the Bay of Bengal is being exploited at present. It is expected that in the next five years about 8,000 more fishing trawlers will be launched into operation by the Southern States alone. Timely and appropriate, therefore, it has been to consider the possibility of introducing ferrocement as a boat building material which could under certain circumstances contribute towards a substantial reduction in initial costs and maintenance.

The first ferrocement boat to be built (a prototype fishing trawler) was 9.75 m long with a displacement of 6.75 tonnes. After extensive trials, the Cochin Port Trust Authorities registered this boat and it is now successfully carrying out fishing operations off the coast of Cochin in Kerala. The total cost of this boat is reported to be Rs 80,000 (nearly US\$10,000).

The Department of Fisheries of the Government of Tamil Nadu (South India) has already built about half a dozen boats ranging in size up to about 11.5 m. Presently they are contemplating larger boats of about 16.5 m in size.



Other structures on water that are being considered as candidates for ferroceement construction in India include house boats, floating bridges, floating dry docks, floating shelters for certain flood prone areas and coracles.

### **Ferroceement for Food Storage Facilities**

Increasing supplies of food grains such as rice, wheat and maize have caused an unprecedented need for grain storage. In addition, grain storage facilities are urgently needed to protect all products sensitive to temperature, humidity, rain, wind, pest, animals, bacteria and fungi. Other typical products requiring storage are peas and beans, salt, drinking water, fertilizer, pesticides and cement.

In India ferroceement is being introduced for silos in sizes to hold about 1 to 30 tonnes of grain. Methods developed for ferroceement boat building are being applied to these storage structures with a view to obtaining a structure of high quality. These silos can be easily sealed against water vapour with a rubber or bitumen based paint.

### **Ferroceement for Gobar Gas Plants**

A number of gobar gas plants have been constructed by the Cement Service Bureau at Madras in South India using ferroceement technology and also by the Ferroceement Craft Research Project of the Government of Tamil Nadu. The gas holders of these plants are fairly light being only about less than a centimetre in thickness and costing only about a third of its steel counterpart.

### **Ferroceement for Water Tanks and Utility Buildings**

Impermeability is an important characteristic of ferroceement in its use for water retention.

India is giving serious attention towards evolving convenient designs of ferroceement water tanks of capacities ranging from 200 to 5000 gallons. Factory produced tanks can be designed for convenient handling with simple equipment.

By the simple process of placing a window or door frame against the inside form before plastering, a water tank could be conveniently transformed into a tool shed, site office, pump room/or small laboratory. Electrical circuits can be embedded in plaster.

### **Other Potential Applications of Ferroceement**

Other areas where ferroceement is being tried to a limited scale in India are:

- a) Large span roofs (including shells and folded plates)
- b) Cattle feeders, water troughs and vats for fish ensilage
- c) Grain and copra driers
- d) Pipes and irrigation conduits
- e) Wall panelling
- f) Timber treatment enclosures
- g) Architectural panels and finishes
- h) Components of furniture

## **Exploratory and Intensive Research and Development**

The investigations described above are essentially exploratory in nature. Some of the applications require intensive laboratory analysis; some testing and demonstrations and pilot trials on both the properties of the materials and the structure. Ferrocement should thus be subjected to a wide ranging programme of R&D with a view to exploring and harnessing all its potential strong points and weaknesses and hence its appropriate applications.

Most of the investigations carried out in India are essentially on basic structural elements such as flexural, tensile and compressive member and on the materials that go into ferrocement. When thin ferrocement elements are used in full scale structures such as shells, folded plates and hanging roofs, problems such as buckling and rigidity are encountered. Also since these structures are subjected to a complex system of stresses, information based merely on the tests on the basic elements is not adequate for the design of such structures. This calls for tests on models of prototype structures to study their behaviour in a realistic manner. This is an area where there is considerable scope for experimental research specially nondestructive testing techniques.

## **Training Facilities in Ferrocement Technology**

Special training schools should be added to existing technical institutions or separate establishments set up with a view to training personnel to establish inland and marine construction facilities and to supervise ferrocement construction projects.

## **Dissemination of Information in Ferrocement Technology**

A strong information centre within one of the existing technical institutions (already possessing competence and ongoing programmes on ferrocement technology) should be organized with a view to maintaining an industrial information bank and rendering enquiry referred service on ferrocement. This centre will disseminate all information on R&D efforts, current developments and advances in ferrocement technology and experiences in applying this technology.

## APPENDIX N

FERROCEMENT RESEARCH AND DEVELOPMENT  
AT UNIVERSITY OF SINGAPORE.

by

P. Paramasivam, G.K. Nathan and S.L. Lee

**Introduction**

The mechanical properties of ferrocement and fibre reinforced materials have been investigated by conducting tensile, flexural and impact tests at the University of Singapore in the last three years (1, 2, 3, 4). In the experimental study conducted, the effect of parameters such as percentage volume of reinforcement on mechanical properties of ferrocement were considered. Using an analytical model based on composite material approach, expressions were derived to predict the tensile stress at first crack, Young's modulus and ultimate tensile strength of ferrocement and verified by experimental results (2). A study on fibre reinforced concrete, composed of plain mortar with one layer of wire mesh and randomly distributed fibres, was also carried out. Analytical expressions were proposed to predict the ultimate tensile strength and Young's modulus in the uncracked region (3) of this composite material.

As practical applications of ferrocement, the feasibility of constructing a 23-ft length ferrocement boat, a 8-ft diameter water tank and 1-in thick secondary roofing slabs for use in high rise buildings were successfully carried out. The analysis and construction of these ferrocement structures are discussed briefly in the following.

**Construction of Ferrocement Boat**

To date ferrocement has been used mainly as a construction material for boats longer than 30-ft length because the minimum thickness which could be achieved when skeletal steel is used as a reinforcement is about  $\frac{3}{4}$ -in. When ferrocement of  $\frac{3}{4}$ -in thickness is used, for boats of smaller length, it results in very much heavier boat than when using any other construction materials.

The problem was resolved by using a ferrocement material which has only wire mesh as reinforcement, without skeletal steel, but having the required strength. Lloyds 100A1 specification in its provisional requirement for ferrocement boats specified that the stress at first crack should be at least 1300 psi, with a minimum ultimate strength of 1690 psi. This was possible with this type of ferrocement constructed with a thickness of  $\frac{1}{2}$  in, which led to the design of a 23-ft boat comparable in weight when constructed with timber.

The ferrocement used in this construction is reinforced by 0.33 in x 0.33 in woven wire mesh of 0.034 in diameter. The cement, sand and water ratio is 1:1.5:0.45. An earlier study has shown that sand used in ferrocement should pass through sieve B.S. No. 14 and greater than No. 100 and this type of aggregate was used. The cement used was Type I normal portland cement.

In the construction of the hull, a rigid framework is required to support the weight of the wire mesh and wet mortar, at the same time giving the hull its all important shape.

Framework made up of hollow mild steel pipes of  $\frac{3}{4}$  in diameter and  $\frac{3}{16}$  in thickness was used. Lofting and fairing of the line diagram was done on the floor and the pipes were bent to the inside curves of this diagram. Bent pipes, for each station point, were pre-assembled into a frame by tying with wires. The keel pipe and the station frames were then set-up, using a scaffolding to keep it in position at the construction site. After the framework was satisfactorily faired and welded together, the layers of wire mesh, two inside and three outside the framework, were laid and tied at regular interval.

Plastering of the hull was carried out in a single day starting from the keel and a portable vibrator was used to consolidate the mortar in the keel block. Finally, completed ferrocement hull was cured and finished with a special filler to obtain waterproofing and to have a smooth surface on the outside. Figures N1 to N3 illustrate different stages of construction.

### Construction of Ferrocement Water Tank

The analysis of the cylindrical ferrocement water tank was carried out in two parts by linear elastic theory. The first part dealt with the cylindrical shell wall and the second part with the base plate. The total solution for the entire tank was obtained by imposing appropriate boundary conditions at the junction of the base plate and the wall.

Several important factors were considered before a decision was made on the dimensions and amount of reinforcement required for a prototype water tank. In view of the roof plan of the highrise building on which the tank will be installed, a tank 8-ft in diameter and 8.5 ft in height was selected. The wall and base thicknesses adopted were 1.25 in and 2.25 in respectively. From the analysis, it was found that the maximum hoop stress governs the design of the cylinder which was proportioned with a safety factor against the development of cracks. In this design, the estimated cracking stress and the maximum hoop stress are 335 psi and 126 psi respectively.

The cement, sand and water ratio of 1.0:1.5:0.4 was used for the mortar. The admixture of rapidard was added to increase the workability in the proportion of 2273 cc per bag of cement of 112 lb. The fine aggregate and the wire mesh are similar to that used in the construction of the ferrocement boat discussed previously. For the skeletal steel, 6 in x 6 in BRC weld mesh of 0.2 in diameter was used to form the shape of the cylinder and base plate, rigid enough to carry the weight of the reinforcement and wet mortar. Three layers of wire mesh, two layers of BRC weld mesh and  $\frac{3}{8}$ -inch diameter mild steel bar were used for the base plate and, for the cylindrical walls, three layers of wire mesh and two layers of BRC weld mesh were used. Particular care was taken at the junction between the cylindrical wall and the base plate by weaving the vertical wire mesh through the reinforcement of the base for continuity. Figure N4 to N6 show the construction and plastering of the tank at different stages.

The tank was filled with water and observed for more than 3 months and there was no leakage even without any water proofing coating. Cost comparison was made and it was found that ferrocement water tank is cheaper by about 30 percent in comparison with steel tank of the same capacity based on local cost.

### Ferrocement Secondary Roofing Slab

In many highrise buildings in Singapore, a secondary roof is provided for thermal insulation of flats in the top floor. This normally consists of 2 ft x 5 ft rectangular slabs supported on the corners by 9-in high concrete blocks placed on the structural roof to provide

an air pocket. These rectangular slabs are made of light weight 2-in thick concrete with one layer of BRC weld mesh. Cracks often appear after a short term of service. Therefore, the use of ferrocement slabs is investigated as a substitute.

The slab is 3 ft square and 1-in thick, selected in consideration of the weight in regard of handling problem and the economical use of the wire mesh. A cement, sand and water ratio of 1.0:1.5:5:0.4 was used. Different types and lay out of wire mesh were tried. The final design consists of two layers of 0.5 in x 0.5 in wire mesh with 0.0639-in diameter and one layer of 6 in x 6 in BRC weld mesh with 0.125-in diameter. The construction and testing of the slabs were shown in Figures N7 and N8. Preliminary observations show that the ferrocement slab is satisfactory in terms of crack resistance and economy. The strength is much more than required.

### Conclusion

At present, research program on mechanical properties of ferrocement and fibre reinforced materials and their applications to floating pontoons, water tanks and shell structures are in progress.

### References

1. Nathan, G.K., Paramasivam, P., Lau, J.M., and Teo, T.P. 'Mechanical Tests and Properties of Ferrocement Material', University of Singapore Technical Bulletin 23, Singapore, 1973.
2. Nathan, G.K., and Paramasivam, P. 'Mechanical Properties of Ferrocement Material' Proceedings of First Australian Conference on Engineering Materials, University of New South Wales, Sydney, 1974.
3. Paramasivam, P., Nathan, G.K., Fiu, F.K. and Ping, L.P. 'Study of Fibre Reinforced Concrete' Proceedings of First Australian Conference on Engineering Materials, University of New South Wales, Sydney, 1974.
4. Paramasivam, P., Nathan, G.K., Lau, J.M. and Teo, T.P. 'Ferrocement as an Alternative Material for Boat Building in Singapore, IES Journal, Singapore, Vol. 14, No. 1, December 1974.

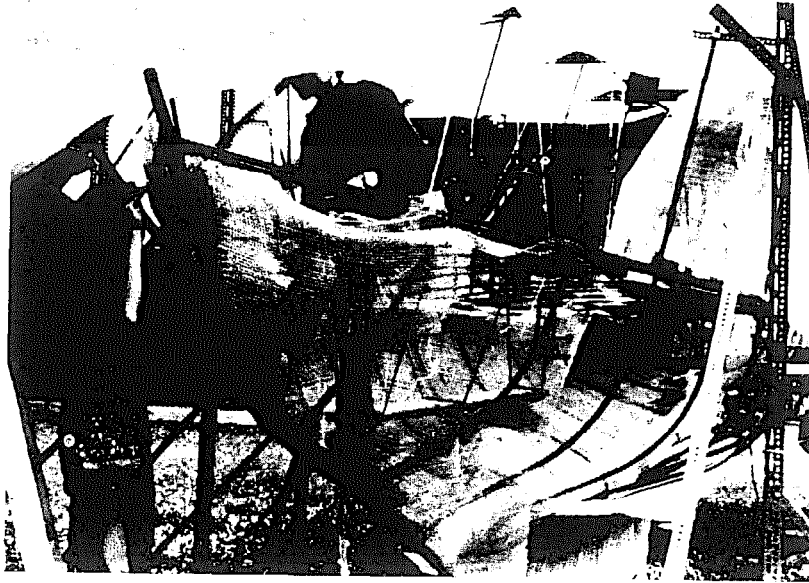


Figure N1: Assembled Framework

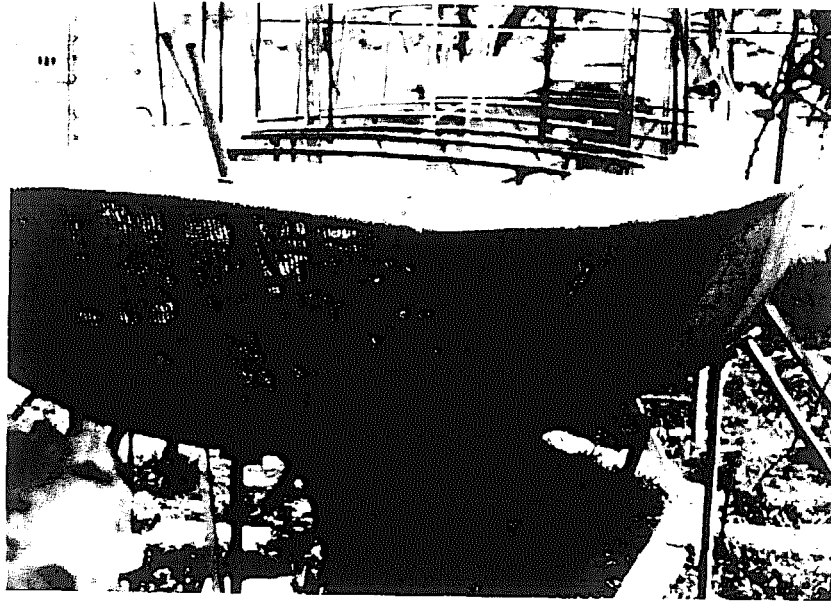


Figure N2: Hull after Laying of Wire Mesh Prior to Plastering

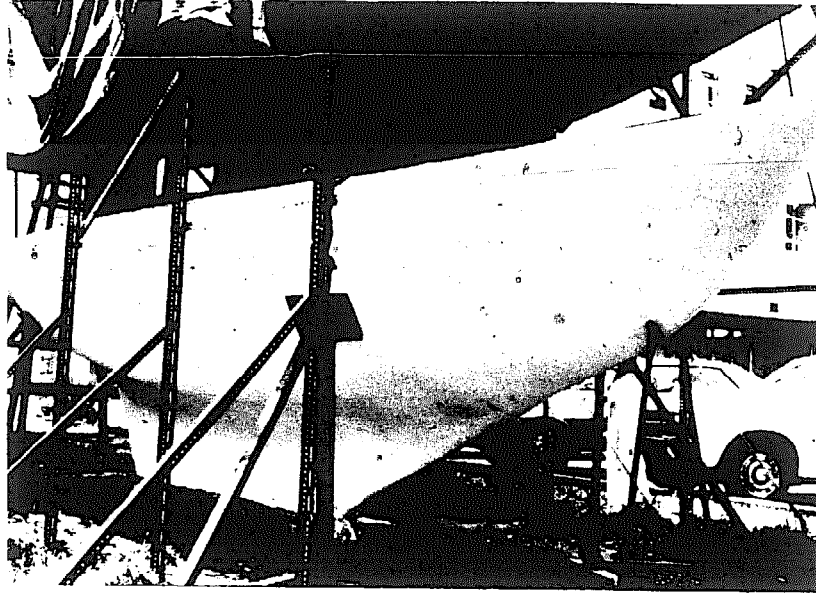


Figure N3: Finished Ferrocement Hull

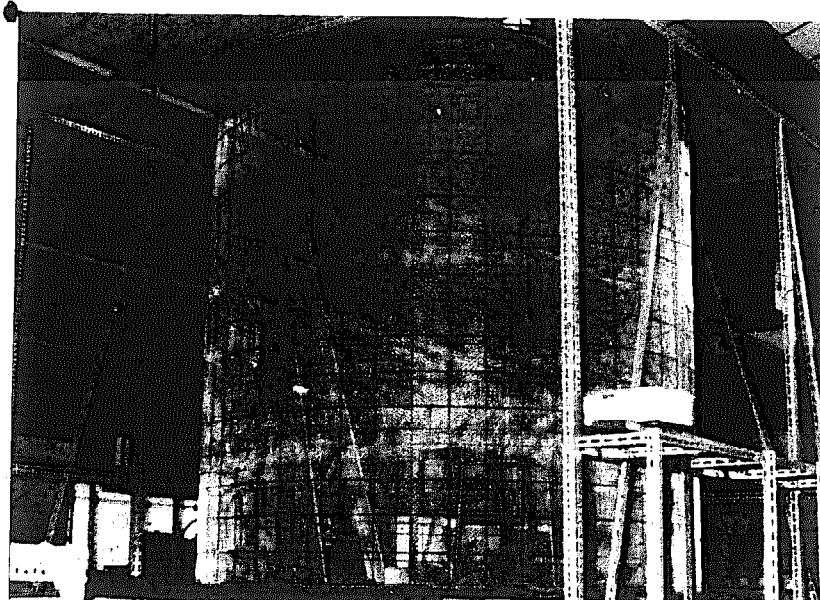


Figure N4: Reinforcement Details of Water Tank

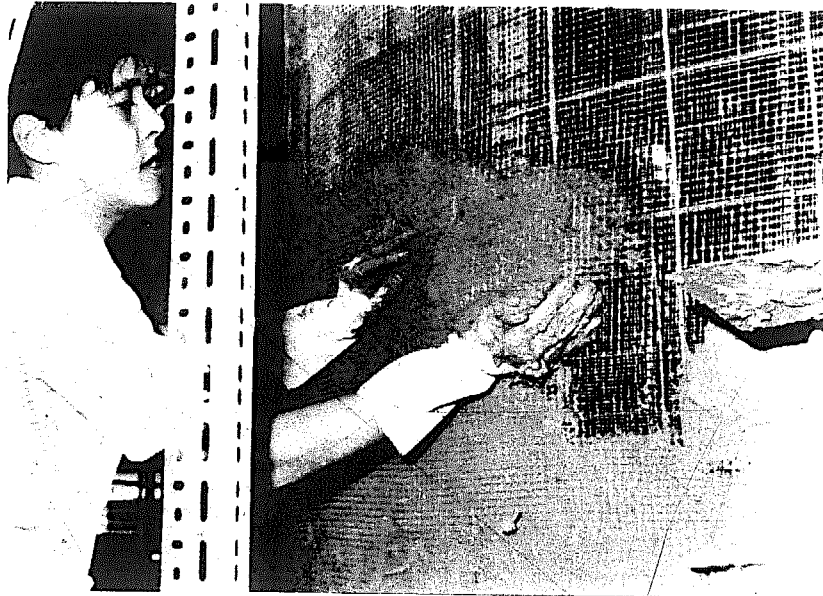


Figure N5: Plastering of Tank Wall

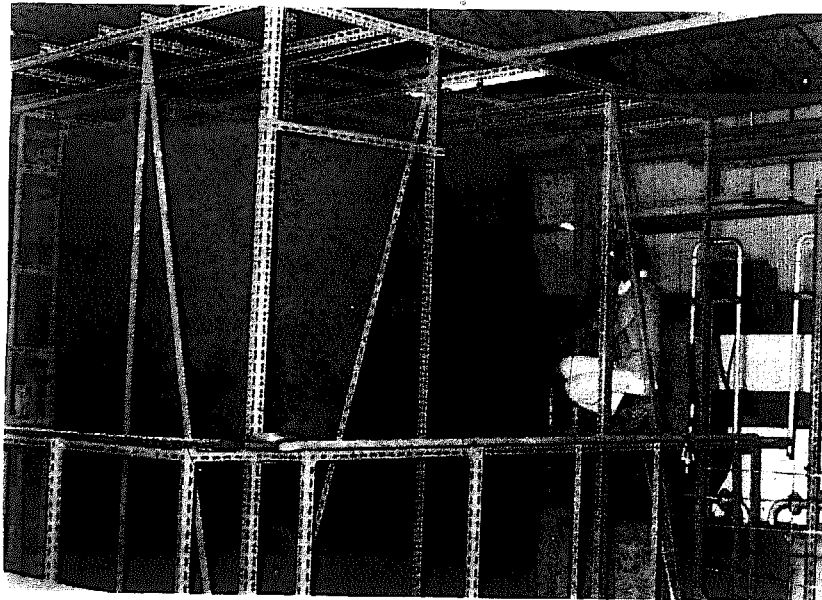


Figure N6: Finished Water Tank



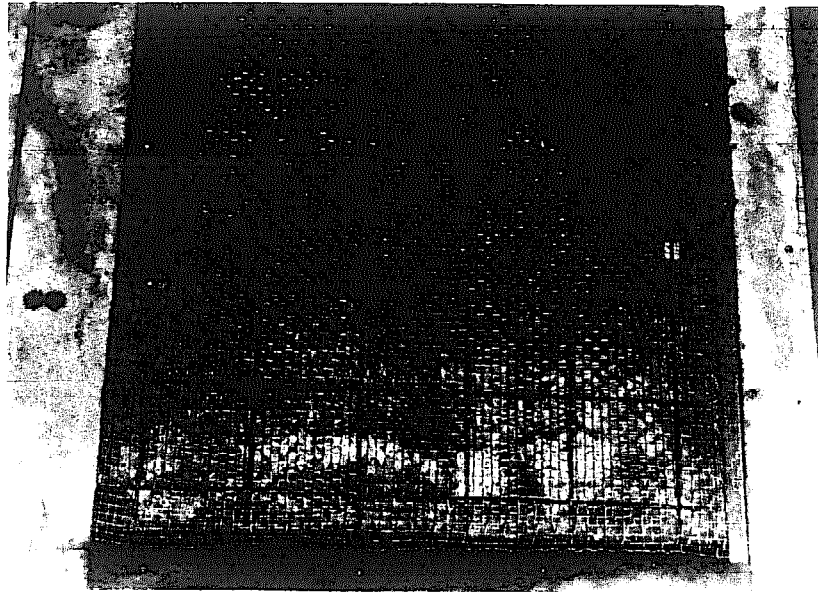


Figure N7: Reinforcement Details of Secondary Roof Slab

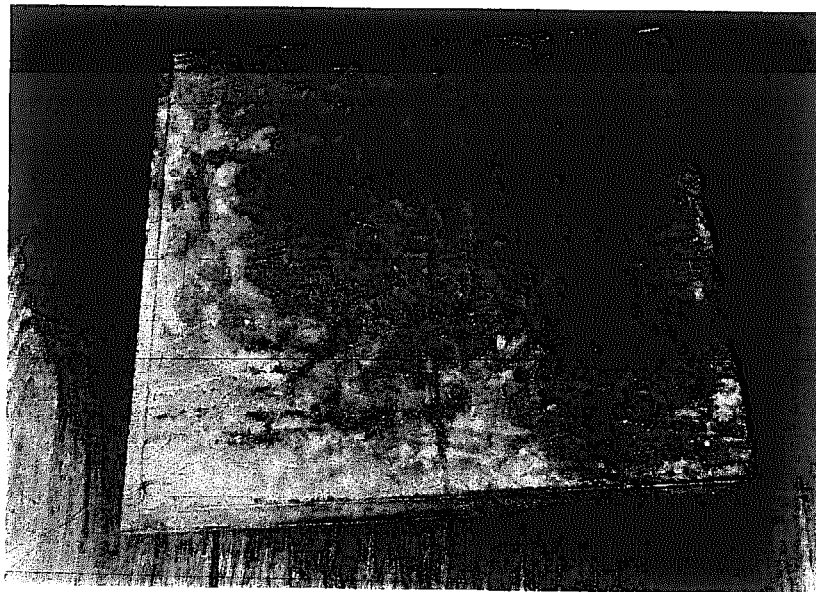


Figure N8: Finished Ferrocement Secondary Roof Slab