

# AM LOOP ANTENNAS

## Introduction

An AM loop antenna is one of the true marvels of electronics. Requiring no power, it takes advantage of the resonant properties of an inductor and a capacitor connected in parallel to receive weak AM stations. The "loop" part of the antenna is the inductor, and the tuning capacitor makes it resonate at a desired frequency. As a boy in Abilene in 1967, I discovered the basic principle of the loop antenna. By removing a relatively small spiral loop in my five tube table radio, and substituting a much larger loop salvaged from an older radio, I could receive my favorite station - [KLIF](#) from Dallas better. I hid the loop in a cardboard holder featuring the logo of a favorite rock band, and enjoyed many hours of good listening. Lacking the mathematical background to understand antenna theory - I could not take the concept to the next phase: designing my own loop. Nevertheless, the spiral loop - combined with the antenna section of the radio's tuning capacitor - formed a very good loop antenna. I understood quite well that the bigger the loop, the more stations I could receive.

The schematic diagram of an AM loop antenna is shown below. It consists of an inductive winding, which is supported on a frame, and a variable tuning capacitor that can be salvaged from a junk radio. The inductive winding consists of a primary, which forms a resonant network with the tuning capacitor, and a secondary "sense" winding that can be connected to a radio. In practice, however, the sense winding is not needed if the loop antenna can be placed near the radio - mutual coupling will take place with the antenna in the radio.

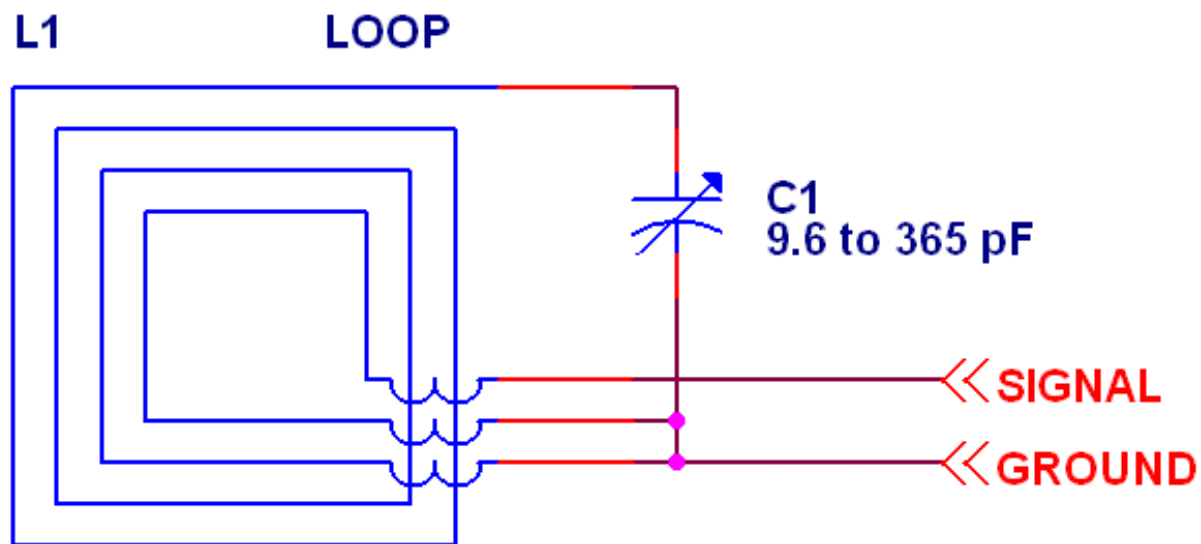

As nice as loop antennas are, there are some limitations you might want to consider before considering one:

- Large loops may be quite large and cumbersome. Even 8 inch loop antennas, however, may have high gain. Radio Shack and Terk manufacture very similar products - an 8 inch circular loop with a tuning capacitor embedded in the base. These small loop antennas can turn radios with poor sensitivities into modest DX rigs. Just don't expect a 6 transistor pocket radio to provide excellent reception if the distant station is near strong local

stations - the selectivity and automatic volume control of the inexpensive receiver may not be up to the task.

- Loop antennas can be a bit difficult to use. If the target station is audible at all on the radio - it is a simple matter to put an external loop antenna nearby, and tune it until the weak station becomes strong. If the distant station is not audible at all, it may take several tries to "get it right". I discuss my remote reception site at length in the four foot loop article - so I won't go into detail here. I will mention briefly, however, that the radio in my daughter's room at "grandad's" is a 25 year old Radio Shack table model. There is no signal audible at all on my daughter's favorite station, which meant I had to tune the radio to a station nearby - then tune the loop, then edge up the frequency on the radio, then the loop - etc. until the station comes in. The 8 inch Radio Shack loop brings it in almost without static! Once the radio was set, all I have to do is leave it from one visit to another. When I arrive, I put the loop near the radio, turn the radio on, tune the loop - done. Not too bad. Now if somebody ever touches the tuning on that radio between visits - it will be a bit of a hassle!

## Why Another Loop Antenna Page?

Many articles have been written describing the construction of loop antennas, but they have been deficient in many respects. Some areas that are never adequately explained are:

- The differences between spiral winding and edge winding – which is better and why. I have elected to construct edge wound loops – it makes calculations easier.
- Whether the winding is spiral or edge, what is the spacing between the turns of the winding?
- Does the winding really relate to a standard tuning capacitor with a value of 9.6 to 365 pF, or does it use another value? My construction articles will specify the value of capacitance.
- Does the loop handle frequencies in the expanded band from 1610 to 1700 kHz?
- How is the loop interfaced to a receiver – where and how do you place the secondary? How many turns should the secondary be?

This introductory article will describe the mathematics of AM Loop Antennas and serve as the link point for construction articles. I have actually constructed several loop projects, and conducted controlled test of them from a remote test site. Construction projects are linked below.

## Mathematics of Rectangular Loop Antennas

A loop antenna resonates according to the formula:

$$f_o = \frac{1}{2\pi\sqrt{LC}}$$

where:

- $f_o$  is the resonant frequency in Hz
- $L$  is the inductance of the loop in Henries
- $C$  is the capacitance of the loop in Farads

The problem for loop designers comes in designing a loop with the desired value of inductance for their tuning capacitor. Ideally, the fully meshed position of the tuning capacitor should tune the loop antenna just below the lowest frequency in the desired band, and the fully open position of the tuning capacitor should tune the loop antenna just above the highest frequency in the desired band. In practice, this is sometimes a challenge because the AM band tunes over a frequency range that is 3:1 (1700 / 540 = 3.15). Surprisingly, I get the best results by adding more turns to the loop so I can use the newer 9.6 to 250 pf tuning capacitors. But then - there was a reason why transistor radio manufacturers did this in the first place - could it possibly be that it was easier to design antenna sections that tracked the entire band?

There are two formulas for loop inductance that I have found on the web - the Joe Carr formula and the UMR-EMC lab (University of Missouri-Rolla Electromagnetic Compatibility Laboratory) formula. I have used both in building loop antennas, and find the UMR-EMC lab formula works a little better. Both formulas are large, both are ugly. But this is the nature of loop antennas.

Incidentally, the "holy grail" of loop antenna design would be a formula that gives the dimensions of the frame based on the frequency, number of turns, and spacing of turns. I spent many hours working to derive such a formula from both the Joe Carr and UNC-EMC lab formulas. My attempts at derivation failed. The best thing for you to do is to tweak the dimensions of your loop to get the inductance - and therefore the frequency range - where you want it.

### The Joe Carr Formula

The Joe Carr's Tech Note formula has worked for large square box loop antennas with wide spacing between the windings. It does not work for ribbon cable loops. It approximates rectangular loops provided that the aspect ratio is not too large. The formula is:

$$L(\mu\text{H}) = 0.008 \times N^2 \times A \times \left[ \ln \left( \frac{1.4142 \times A \times N}{(N+1) \times B} \right) + 0.37942 + \left( \frac{0.333 \times (N+1) \times B}{A \times N} \right) \right]$$

Where:

- **L** is the loop inductance in  $\mu\text{H}$
- **A** is the length of one side of the loop in cm
- **B** is the loop depth (thickness) in cm
- **N** is the number of turns

I have taken the Joe Carr formula and created a [Javascript calculator](#) for square loop antennas.

### The UMR-EMC Lab Formula

The UMR EMC Lab formula appears to be a more general form of the Joe Carr formula. If I get some spare time, I may try to put  $h = w$  in the UMR EMC lab formula and see if it reduces to the Joe Carr formula. Anybody who wants to do this - write me and tell me if you succeed. The UMC EMC lab formula is:

$$L = N^2 \frac{\mu_0 \mu_r}{\pi} \left[ -2(w+h) + 2\sqrt{h^2 + w^2} - h \times \ln\left(\frac{h + \sqrt{h^2 + w^2}}{w}\right) - w \times \ln\left(\frac{w + \sqrt{h^2 + w^2}}{h}\right) + h \times \ln\left(\frac{2h}{a}\right) + w \times \ln\left(\frac{2w}{a}\right) \right]$$

Where:

- **L** is the loop inductance in H
- **N** is the number of turns
- **w** is the loop length in cm
- **h** is the loop height in cm
- **a** is the radius of the spacing between wires (equal to the wire radius for adjacent winding, equal to 0.0635 for 0.127 (.050 inch) spaced ribbon cable, etc.
- $\mu_r$  is the relative permeability of the medium - just use 1
- $\mu_0$  is a physical constant - the permeability of a vacuum:  $\mu_0 = 4\pi \times 10^{-7} \text{ T}^2\text{m}^3/\text{J} = 12.566370614 \times 10^{-7}$

I also created a [Javascript Calculator](#) for the UMR EMC lab formula.

## The Bob's Tesla Web Lab Formula

Many web articles utilize the [Bob's Tesla Web Lab](#) formula for loop antenna design. This formula is for a round loop, not rectangular, so I really won't go into detail here. It does not seem to work properly, even for circular loops. In challenging the formula so many loop designers and Tesla enthusiasts have used, I must have proof. When I reverse engineered the Terk AM Advantage - which is a circular loop:

- Radius = 4.234 inches
- Coil length B = 1.26 inches
- L = 257  $\mu\text{H}$

The number of turns calculates to 26.96, which is three less than the 30 the unit has. Yet there is no mistaking the fact that it tunes the AM band perfectly. Clearly, the equation is wrong - it produces a number of turns that is 10% too high for square loops of the same area and 10% too low for circular loops.

I still do not have a good formula for a circular loop, but will continue looking.

## Loop Antenna Mechanical Construction

There are two choices for loop mechanical construction - edge wound and spiral wound. My construction articles are all for edge wound antennas, but many articles linked below describe spiral wound loops.

## Edge Wound

An edge wound loop has each turn exactly the same size and on top of the preceding turn:

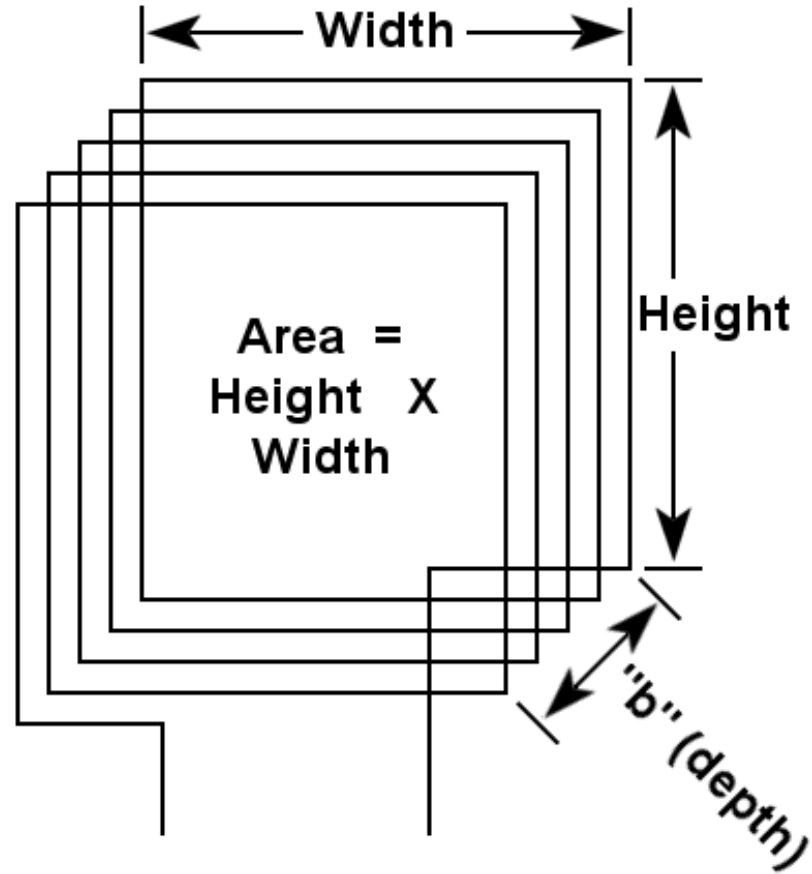

It is most sensitive to signals coming in the plane of the windings:

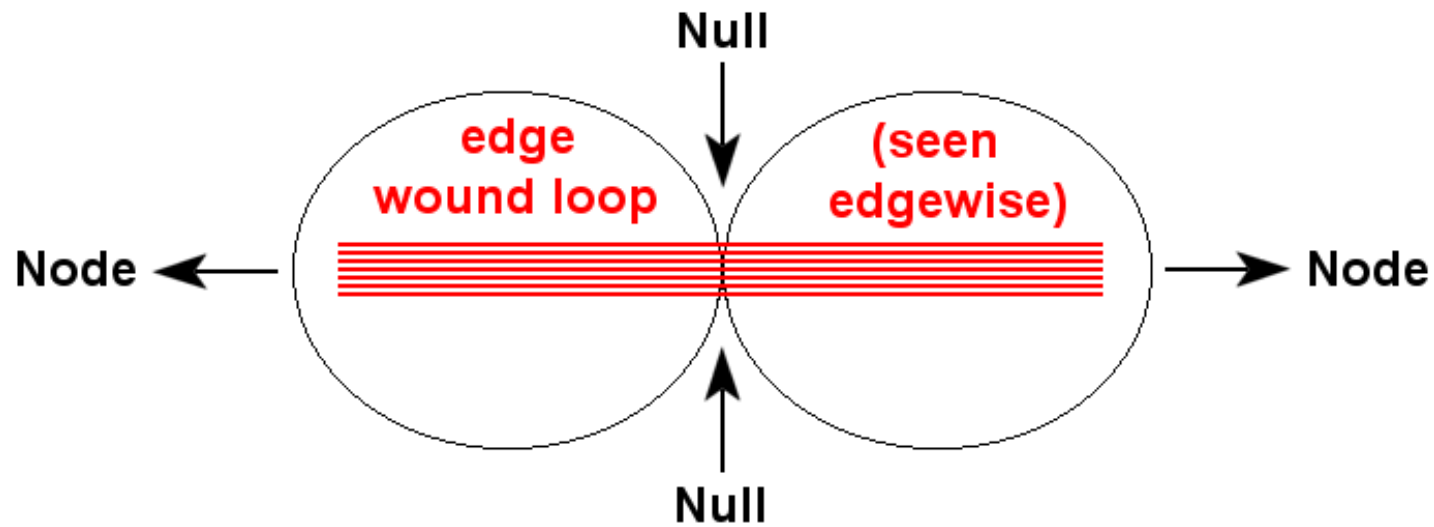

The reception pattern can be visualized as a figure 8 pattern, with the loop most sensitive to anything inside the "8", and less sensitive to anything outside the "8". The actual reception pattern is many times the physical size of the loop - the loop size was increased orders of magnitude in the figure to show the physical construction and orientation. The term "node" refers to the areas of highest sensitivity, and "null" to the areas of lowest sensitivity. While the nodes of loop antennas are quite broad, the nulls can be very sharp. A signal source perpendicular to the axis of an edge wound loop may not be received at all!

### Spiral Wound

A spiral wound loop consists of a flat spiral of wire, where each turn is enough larger than the previous to fit snugly around it:

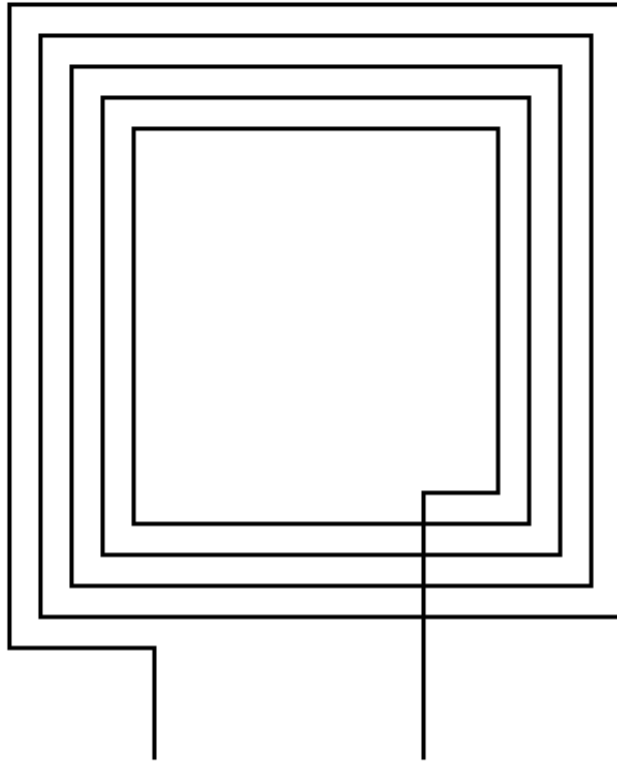

The reception pattern of a spiral loop is shown below:

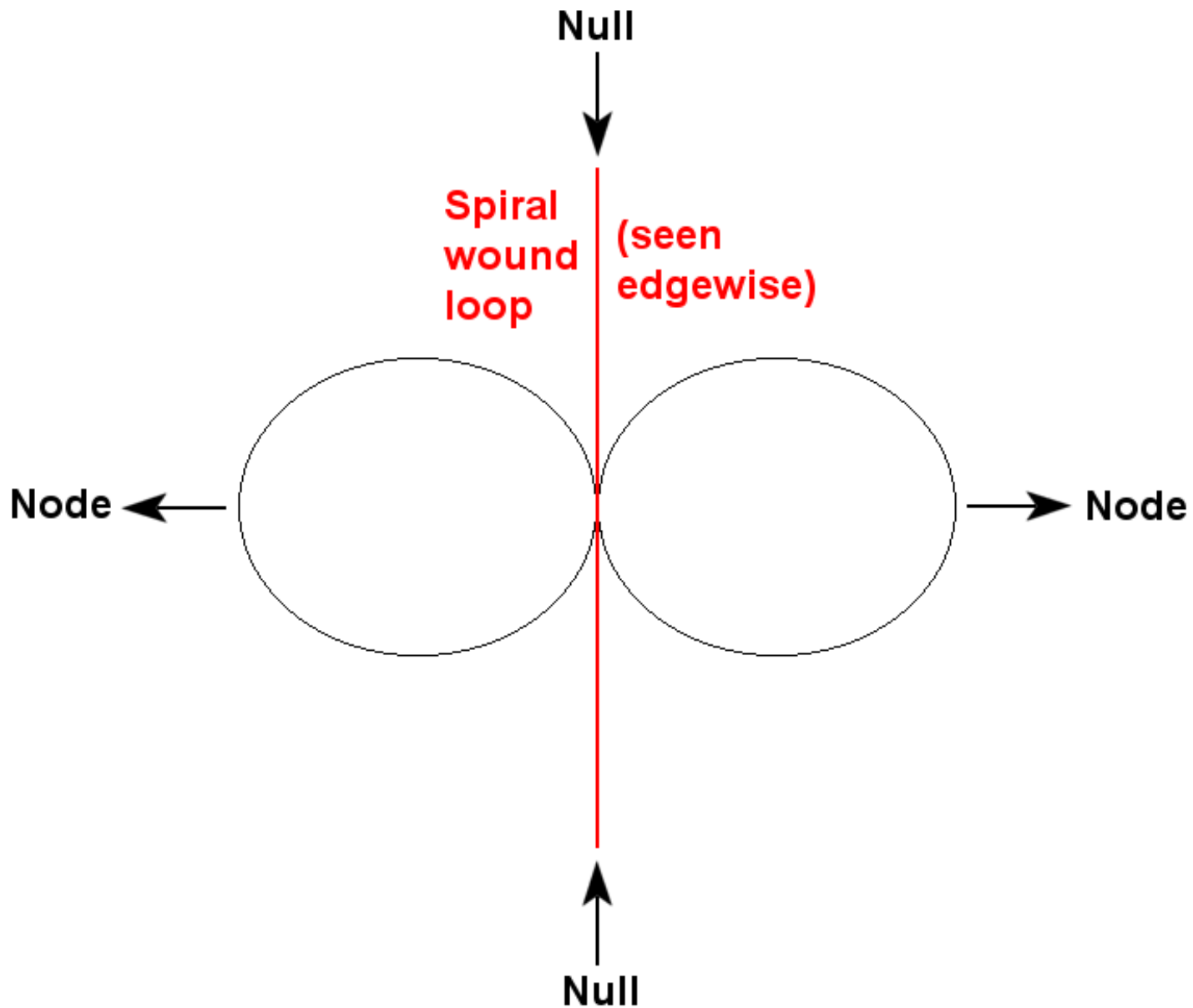

A spiral loop is least sensitive to signals received in its plane.

## A Loop Antenna Tru-ism Proved, and an Unexpected Result!

I recently had occasion to do extensive loop antenna testing in a controlled, laboratory environment. I was working at 27 MHz, but the mathematics and behavior of loops is identical to the behavior of AM loops. Because I was dealing with very small loops, I could make as many loop antennas as I wanted - and they were easy to deal with.



## Bigger is Better

We all know that the bigger the loop, the more sensitive it is. Here is the proof:

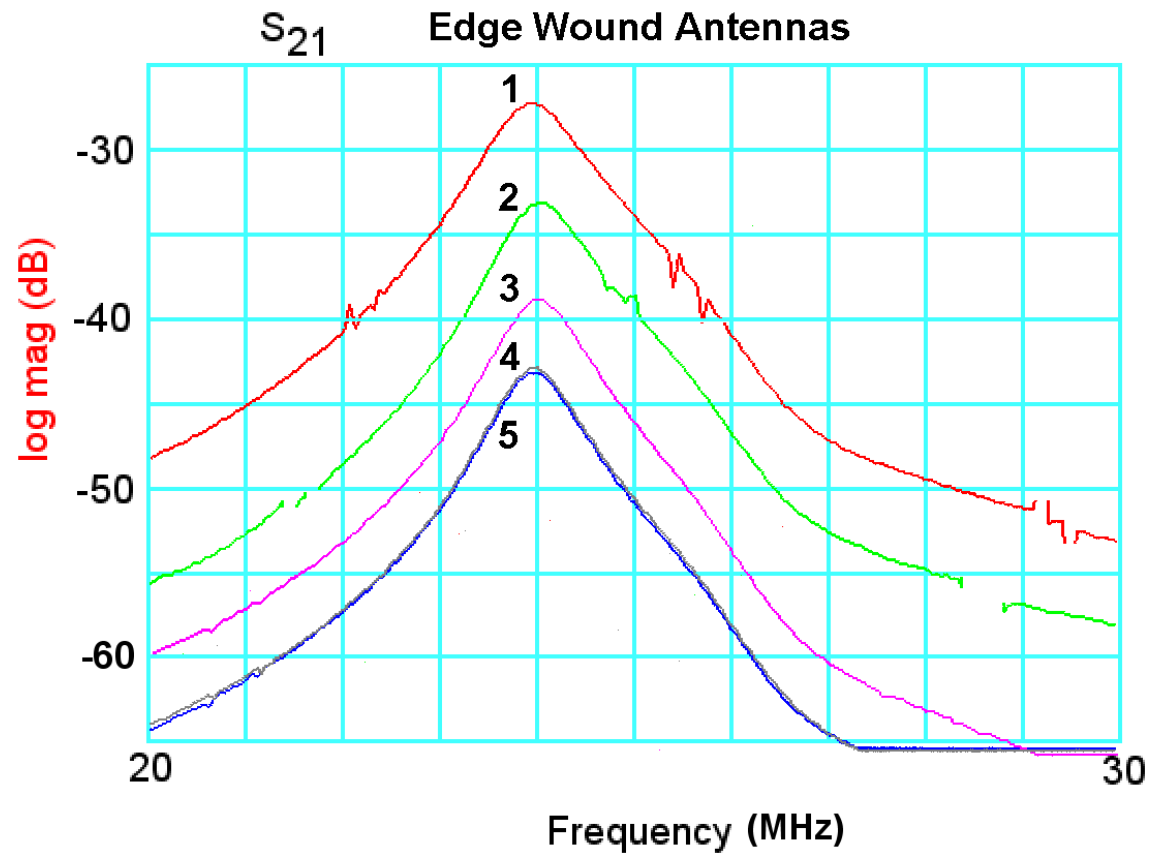

This data, taken from a network analyzer, shows the results for rectangular, edge wound loops varying from a single turn (3.775 inch edge) to 5 turns (0.32 inch edge), which translates to an area ranging from 14 to 0.1 in<sup>2</sup>. All were the same inductance, and resonated with almost the same value of capacitance. It is interesting that the area varied over such a wide range. It is also very interesting that the received signal strength changed in increments of about 5 dB, except for the 4 - 5 turn increment where the mechanics of the loops were increasingly difficult to control (the bending radius of 20 AWG wire made both loops almost identical). Extrapolating this down in frequency and up in size, each time the area is increased enough to require one less turn, you can expect a power increase in the received signal of 5 dB, which is a jump of 3.16:1. To receive really weak signals - make the loop **BIG!** Incidentally, I had almost identical results for spiral wound loops.

### Very Unexpected Result: Increasing the Q Has NO Effect on Sensitivity

Huh?! Is probably what you are thinking. But lab data taken under controlled conditions does not lie. I made three loops that were identical in every respect except for wire gauge. One was made from 30 gauge, the next from 20 gauge, and the last from 10 gauge:

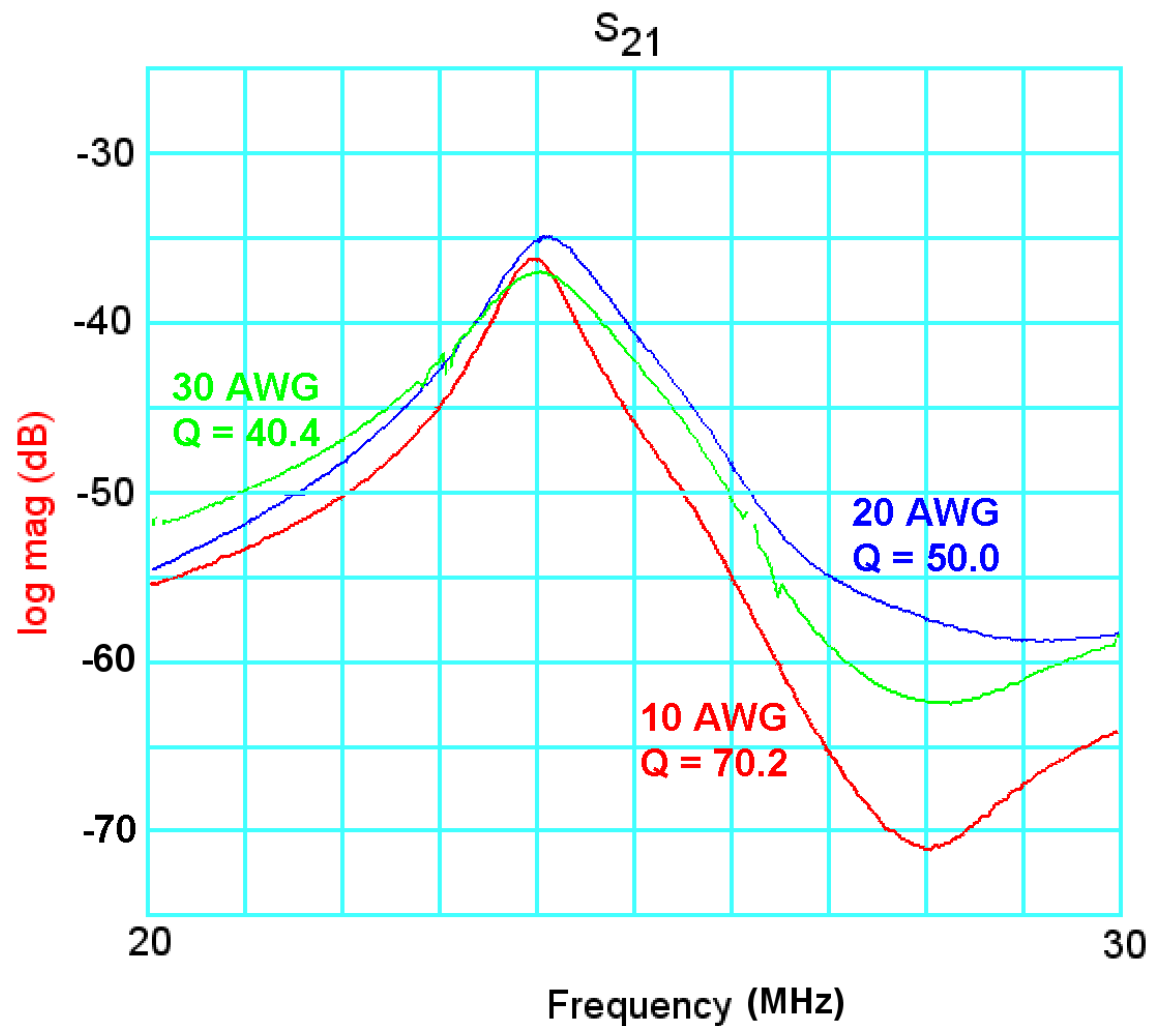

All of the sensitivities were within a dB or so, with no trend that tracked wire gauge. As expected, though, the Q increased with larger gauge wire.

Let step back for a moment and look at the implications of this. Q and sensitivity are two completely different things, and can be controlled independently. Area is the sole determining factor in sensitivity, wire gauge (resistance) is the sole determining factor in determining Q. This means that everybody struggling to find Litz wire (available at [Skycraft](#), by the way) are making very high Q loops, but not necessarily more sensitive ones. If they want sensitivity, they would be much better off making a bigger loop. [Tom Polk](#), a good friend of mine, and crystal / transistor radio expert clued me in to one fact: if you make the Q of a loop too high, you are going to limit your audio frequency response. This may be acceptable if you want to separate out closely packed stations, but be aware of the effect. Litz wire may not be your best choice. It sure corrodes outside!

## Construction Articles

My articles form a sort of chronological "journey" of loop construction projects and things I learned along the way - read them in the order listed below to learn along with me!

- [The Four Foot Loop](#)
- [The Two Foot Loop](#)
- [The Folding Loop](#)
- [The 3 Foot Portable Ribbon Cable Loop](#)
- [The Umbrella Loop](#)

## Where to from here?

- A loop concept so simple I cannot believe I didn't think of it first - a loop constructed on a block of styrofoam. I have made 2 now, they work great! I will put them on here soon, along with long overdue updates to some of the other articles.
- I also wonder if I couldn't make a loop using a flat variation of a Hoberman Sphere. I have seen an awesome flat "Hoberman-like" structure used to support large banners at "Radio Disney" live remotes my daughter goes to. (Obviously we go to the remotes - as KMKI AM 620's fabulous signal makes it an ideal test station from Lubbock, TX). I can't find anything on the web about the display frame - since it is trade show type stuff it may be expensive. But - I have the measurements, perhaps I can find a way to make a loop frame from it.

## Loop Antenna (and Related) Links

- [Loop Aerials & ATU's](#)
- [Magnetic Loop Antenna Experiments by Jeff Imel, KB9ZUR](#)
- [AM Antennas - ABC Reception Advice Website](#)
- [LOOP](#)
- [Amidon Associates](#) Ferrite Rods, Bars, Plates and Tubes
- [Ferrite Rods, Bars, Plates and Tubes](#)
- [High-Gain Preamp](#)
- [A Magnetic Loop Antenna for Shortwave Listening \(SWL\) by KR1ST](#)
- [Receiving Loop Theory - N4YWK](#)
- [Magnetic Loop antenn'e's.](#)
- [RadioIntel.com - THE WOODEN ALTAZIMUTH HOOP LOOP](#)
- [Radio Netherlands Media Network An Introduction to Long Distance Medium Wave Listening](#)
- [Dave's Loop Antenna Page](#)
- [Air Variable Capacitors, Shafted](#)
- [RECEIVING LOOP AERIALS FOR 1.8 MHz](#)
- [LOOP DISCUSSION!](#)
- [Better AM Radio Reception](#)
- [GCC Loop Antenna Design](#) There are now two Yahoo loop antenna groups - this one has the original content
- [Yahoo! Groups loopantennas](#)

## AM Loop Antennas

- [ARES RACES Antenna Projects](#)
- [The Ultimate AM Antenna](#)
- [Doug's R-E Loop Article Page](#)
- [Reception techniques An easy loop](#)
- [amandx-loop](#)
- [AM-FM Reception Tips](#)
- [DX News, Tips and Information page](#)
- [Joe Carr's Tech Notes](#)
- [Rectangle Loop](#)
- [Loop Page](#)
- [AM Radio Reception](#)
- [Coax-Shielded Loop Antenna for 80 - 40 meters](#)
- [a Ten Foot Receiving Loop For Low Frequency Dx Work](#)
- [Rahmenantenne](#)
- [Super Antenna plans](#)
- [Universal LF-MF Preamp](#)
- [Receiving Loop Theory - N4YWK](#)
- [Re Tuned Loop For AM Radio](#)
- [A convenient AM loop antenna](#)
- [Loop Antenna Page](#)
- [Loop Antenna](#)
- [All About Loops - for traffic detection](#)
- [Dave's Loop Antenna Page](#)

Feel free to email me at [\*\*brucec@mindspring.com\*\*](mailto:brucec@mindspring.com) if you have any material that will help to improve this page! Sorry for the unclickable graphic - spammers are scum that harvest email addresses from web pages.

# THE HISTORY OF *KLIF 1190* DALLAS RADIO

---





*Created and maintained by*

***STEVE EBERHART***

*Click [here](#) to enter*

---

Click [here](#) to view my collection at ReelRadio.com

*email me:*

*[steve@historyofklif.com](mailto:steve@historyofklif.com)*

0000024153



<center>

<a href="<http://www.freewebcounter.com>">

</a>

<script language="JavaScript" src="<http://www.freewebcounter.com/pphlogger.js.php?id=stevene>"></script>

<noscript></noscript>

<script language="javascript" src="<http://track.freewebcounter.com/cookie.js>"></script>

</center>



# AM Loop Antenna Calculator

Version 4, 5-19-2003

by Bruce Carter

Enter edge length (inches) :

Enter loop width (inches) :

Select number of turns :

Enter highest capacitance (pF) :

Enter lowest capacitance (pF) :

Loop inductance (uH) :

Lowest tuned frequency (kHz) :

Highest tuned frequency (kHz) :

Wire length required (feet):

## NOTES

1. Tested and known to work in IE6+, Mozilla 1.3+, Opera 7+, and Slimbrowser 3.51+. Does **NOT** work in Netscape versions prior to 6!!!
2. Inter-winding capacitance can upset the calculation. If that happens - decrease the number of turns!



# AM Loop Antenna Calculator - UMR EMC Lab Formula

Version 1, 7-8-2004

by Bruce Carter

**Enter:**

**Loop Width (inches):**

**Loop Height (inches):**

**Winding Spacing (inches):**

**Number of Turns:**

**Enter highest capacitance (pF) :**

**Enter lowest capacitance (pF) :**

**Loop Inductance (nH):**

**Lowest tuned frequency (MHz) :**

**Highest tuned frequency (MHz) :**

(Tested for compatibility with Internet Explorer 6)

Special thanks for all the formulas provided by Bob Schumann

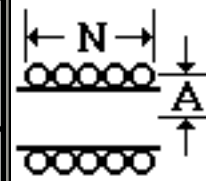

# Formula Collection

**FORMULA NAME: Single Layer Coil Formula**
**FORMULA USAGE: To calculate inductance in single layer coils.**
**APPLICATION: Use to ballpark Tesla coil secondary inductance.**

## FORMULA DEFINITIONS

**L is the inductance in microhenrys.**
**N is the number of turns.**
**A is the mean radius in inches.**
**B is the length of the coil in inches.**

$$L = \frac{(N * A)^2}{(9 * A) + (10 * B)}$$

$$N = \frac{\text{SQR}(L * ((9 * A) + (10 * B)))}{A}$$

$$A = \frac{9L + \text{SQR}(81 * L^2 + 40 * B * N^2 * L)}{2 * (N^2)}$$

$$B = \frac{(((N * A)^2) / L) - (9 * A)}{10}$$

## EXAMPLE APPLICATION

**Secondary diameter is 4 inches. (Let's call this SD)**

**Length of coil windings is 15 inches.**

**Wire diameter is .03 inches.(Let's call this WD)**

**Turns per inch = 1 / wd = 33.3333 (Let's call this TPI)**

**With this prior information we can now determine N, A, and B.**

$$B = 15$$

$$N = B * TPI = 15 * 33.3333 = 500$$

$$A = (SD + WD) / 2 = (4 + .03) / 2 = 2.015$$

**Now plugging into to the above formula to solve for L**

$$L = \frac{(500 * 2.015)^2}{(9 * 2.015) + (10 * 15)}$$

$$L = \frac{1015056.25}{168.135}$$

**L = 6037.150207 microhenrys (Multiply by 10<sup>-6</sup> for henrys)**

**L = .0063715 henrys**

**FORMULA NAME: Resonance Formula**

**FORMULA USAGE: To find resonant frequency**

**APPLICATION: Guess!**

### FORMULA DEFINITIONS

**RF is the resonant frequency in hertz.**

**L is the inductance in henrys.**

**C is the capacitance in farads.**

**pi = 3.141592654**

$$RF = \frac{1}{2 * pi * SQR(L * C)}$$

$$L = (1 / (2 * pi * RF * SQR(C))) ^ 2)$$

$$C = (1 / (2 * pi * RF * SQR(L))) ^ 2)$$

### EXAMPLE APPLICATION

**Let's use the inductance calculated from single layer example.**

$$L = .0063715 \text{ henrys}$$

**Lets say that the secondary and torroid capacitance = 10pf**

$$C = .00000000001$$

**Now plugging into to the above formula to solve for RF**

**1**

$$RF = \frac{1}{2 * 3.141592654 * \text{SQR}(.0063715 * .00000000001)}$$

$$RF = 630520.6113 \text{ hertz}$$

[ [Bob's Tesla Web Lab](#) ] [ [Back to top](#) ]

*Send E-Mail to [tesla@america.com](mailto:tesla@america.com) (Bob Shumann) [Kevin Nardelle](#) THANKS BOB!*



# *SKYCRAFT* Parts and Surplus, Inc. Featuring Electronics and Government Surplus

We Buy And Sell Electronic Components, Test Equipment, Wire, Plus Much More!

[ABOUT SKYCRAFT](#) | [PRODUCTS](#) | [WIRE INVENTORY](#) | [EMAIL](#)

## Welcome to *Skycraft Parts and Surplus!*

We carry thousands of hard to find items such as car audio accessories, power supplies, transistors, relays, Ic's, wire, cable, heat shrink, transformers, test equipment, 19" racks, resistors, and diodes. These items are just a small sample of what we carry. Due to the nature of our business our inventory changes *daily*. For this reason we do not have a catalog. We do offer some items that can be [purchased online](#), however these items are just a small sample of what we have in stock, so if you don't see what your looking for drop us an [email](#) or give us a call (407) 628-5634. Visit some of our [products](#) being auctioned off on Ebay. If you are interested in selling or buying electronic parts or components, Skycraft is the right place. We are a walk-in, hands-on surplus outlet for thousands of surplus and hard to find items.

### Business Hours (E.S.T.)

Mon-Fri: 8:30 - 6:00 p.m.

Sat: 8:30 - 5:00 p.m.

Sunday: Closed

[Check out our online store!](#)



*Skycraft Parts and Surplus in Orlando, FL  
The largest surplus dealer in the Southeast. Over 26 Years of business.*



Copyright © 2002 Skycraft Parts & Surplus Inc.

*With a hobby a man is reasonably secure against the whips and arrows of the most outrageous fortune.*

**SIR WILLIAM OSLER**

**To shift your paradigm and see some neat stuff,  
click on photos !**



**Eye Candy**  
**My Colorful  
Collection of  
Old Radios**



**An Old Passion**  
**Homebuilt  
Telescopes**



**Little Tape  
Recorders**  
**One of the  
World's Few  
Collections**



**A Current  
Passion**  
**Homebuilt  
Musical  
Instruments**



**Sharing the  
Thrill**  
**Helping  
fourth graders  
build crystal  
radios**



**My Encounter  
with Greatness**  
**The Musical  
Instrument I  
Built for Brian  
Wilson's Tour**



**Fine Crystal Radio**  
**I Built This One for a Contest**



**My Tesla Coil**  
**For Some Crazy Reason I Like High Voltage**



**Casting a Plastic Radio**  
**I Try My Hand**



**Musical Composition**  
**I've done this before**

**Home**



# The Four Foot Loop Antenna

## Materials

To construct the 4 foot loop, it is necessary to procure the following material:

- Two 8 foot lengths of 1 by 2 lumber (the actual size of 1 by 2 lumber is  $1\frac{1}{16}$  by  $1\frac{3}{8}$  inches).
- 150 feet of #20 gauge solid wire. Probably the cheapest source is thermostat or doorbell wire, which comes as insulated twisted pair. Simply measure the length of both of the wires, and then take one conductor of the two for the loop. The other conductor can then be used as the secondary wire, or for other purposes. Another source of wire is discarded telephone or network cable – simply splice sections together to make the desired length. These types of wire, however, will give poor results – particularly at the high end of the band. Multi-stranded antenna wire is better.
- A 9.6 to 365 pF tuning capacitor – the large set of plates in a 2 section tuning capacitor salvaged from a junk radio.
- A terminal block, or some other technique for making three connections.
- 8 wood screws, nails, etc.

## Construction

- Cut two  $67\frac{1}{8}$  inch lengths of 1 by 2. These are the braces. Make a notch  $1\frac{1}{16}$  inch wide and  $1\frac{1}{16}$  inch deep in the exact center of each of these braces.

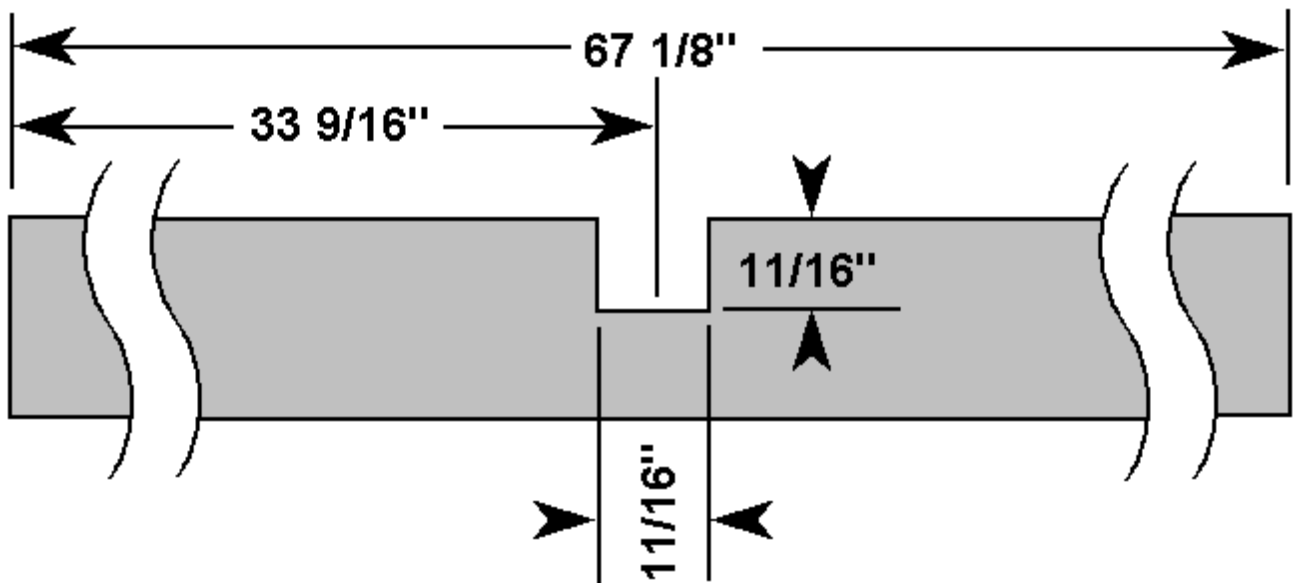

- Make an "X" from the two braces by fastening them together at the notches. Make sure the boards fit together flush, and the two braces form a 90 degree angle. They can be secured with wood glue, or with a screw if the loop must be disassembled.



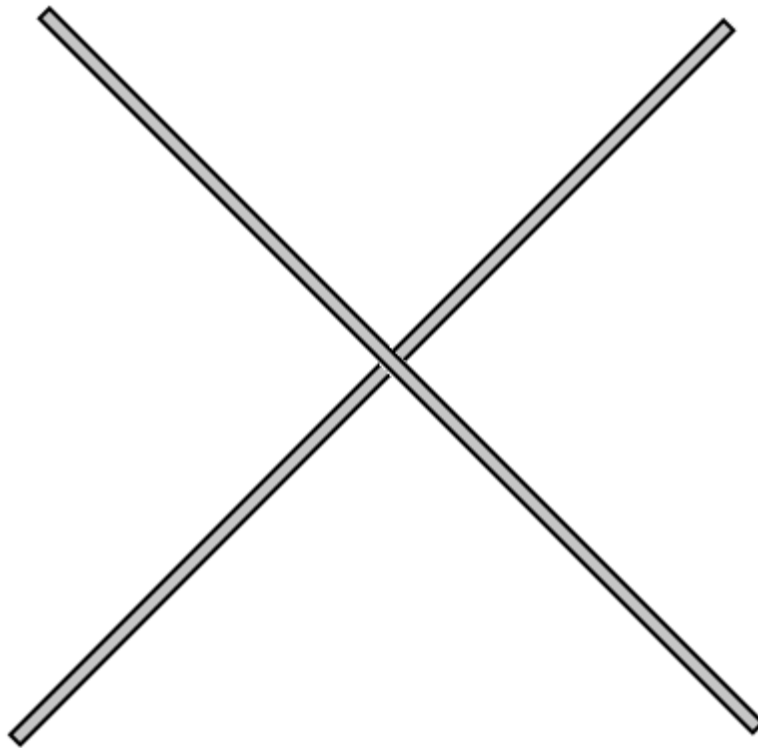

- Using the scrap pieces of 1 by 2, make 3 eight inch blocks of wood, and one 12 inch block of wood. The 12 inch block of wood will be the tuning block and wire support, the other three will be wire support.
- In the middle of the 3 eight inch blocks, drill two holes 1/8 inch holes spaced 3/4 inch apart for wood screws. Countersink the holes so the screws will not interfere with the wire.

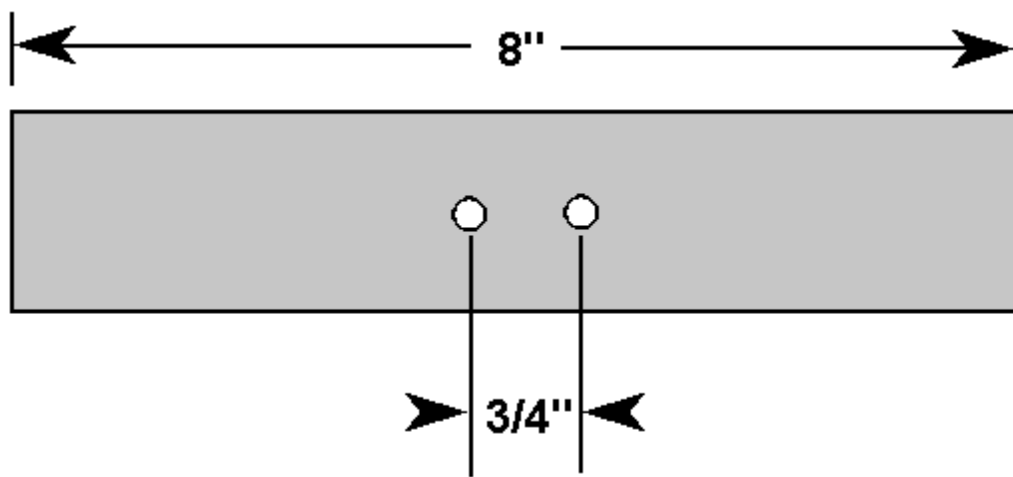

- Prepare the turning block as shown below.

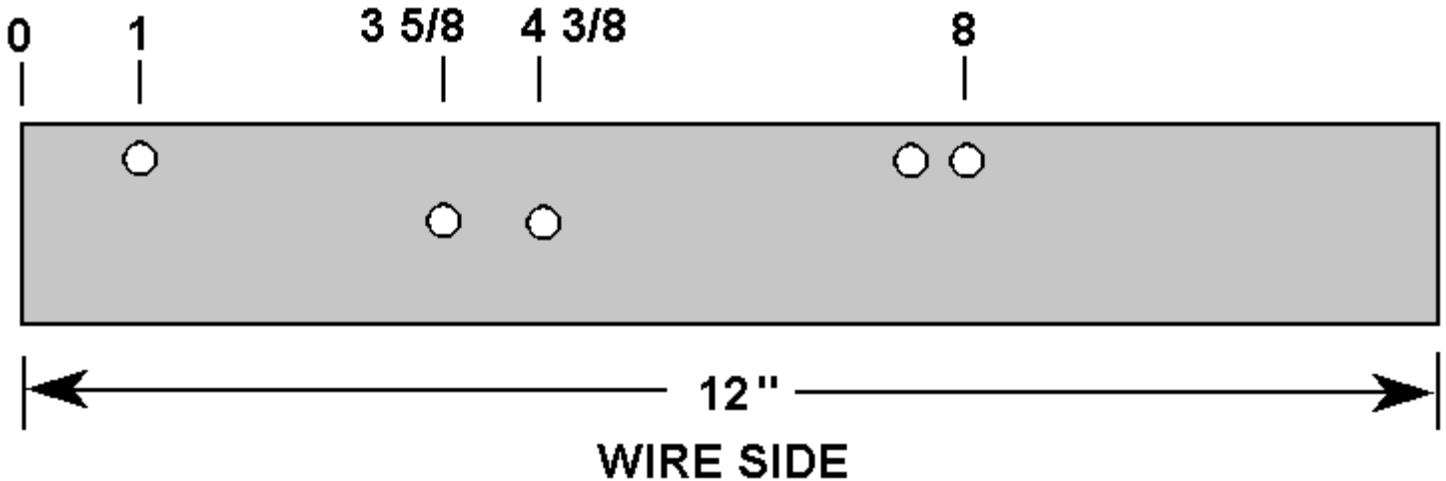

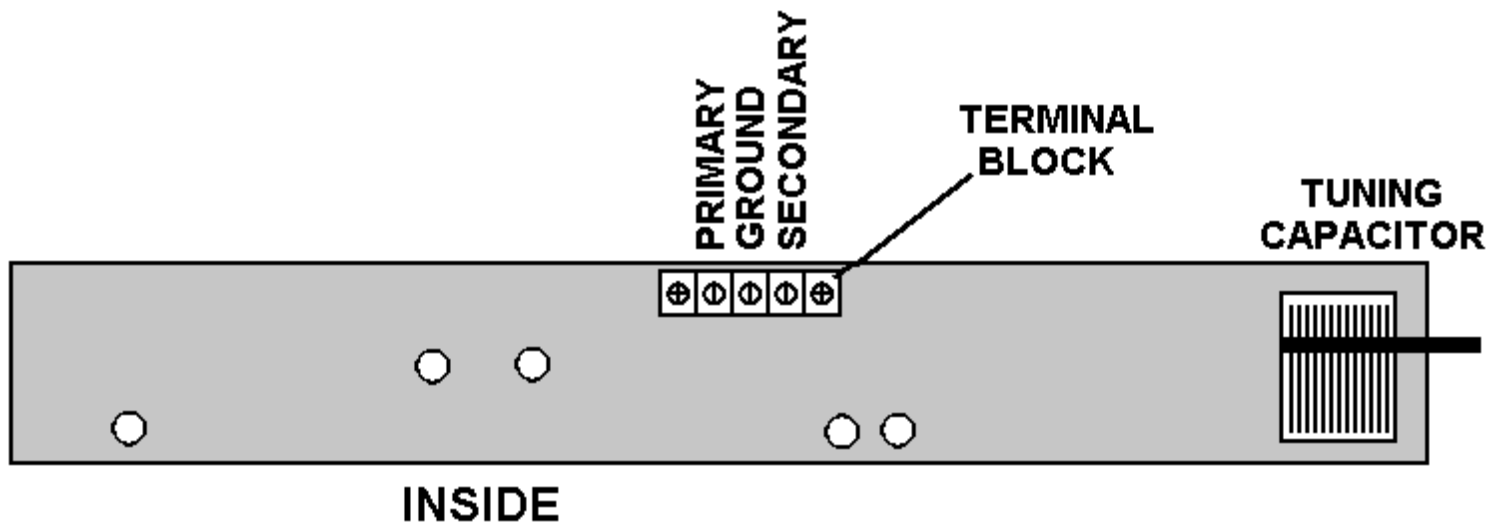

- Attach the terminal block with two wood screws. Attach the tuning capacitor to the board with screws, adhesive, or double backed foam tape. If the tuning capacitor has to be remotely located because the loop is installed outdoors, put it in a weatherproof outdoor enclosure. The tuning capacitor can be coupled to a remotely controlled stepper motor to achieve remote tuning.
- Attach the three wire supports and one tuning / wire support to the ends of the “X” formed by the crossbraces. It may be necessary to pre-drill the ends of the braces, as the wood may tend to split. Wood glue may also help.

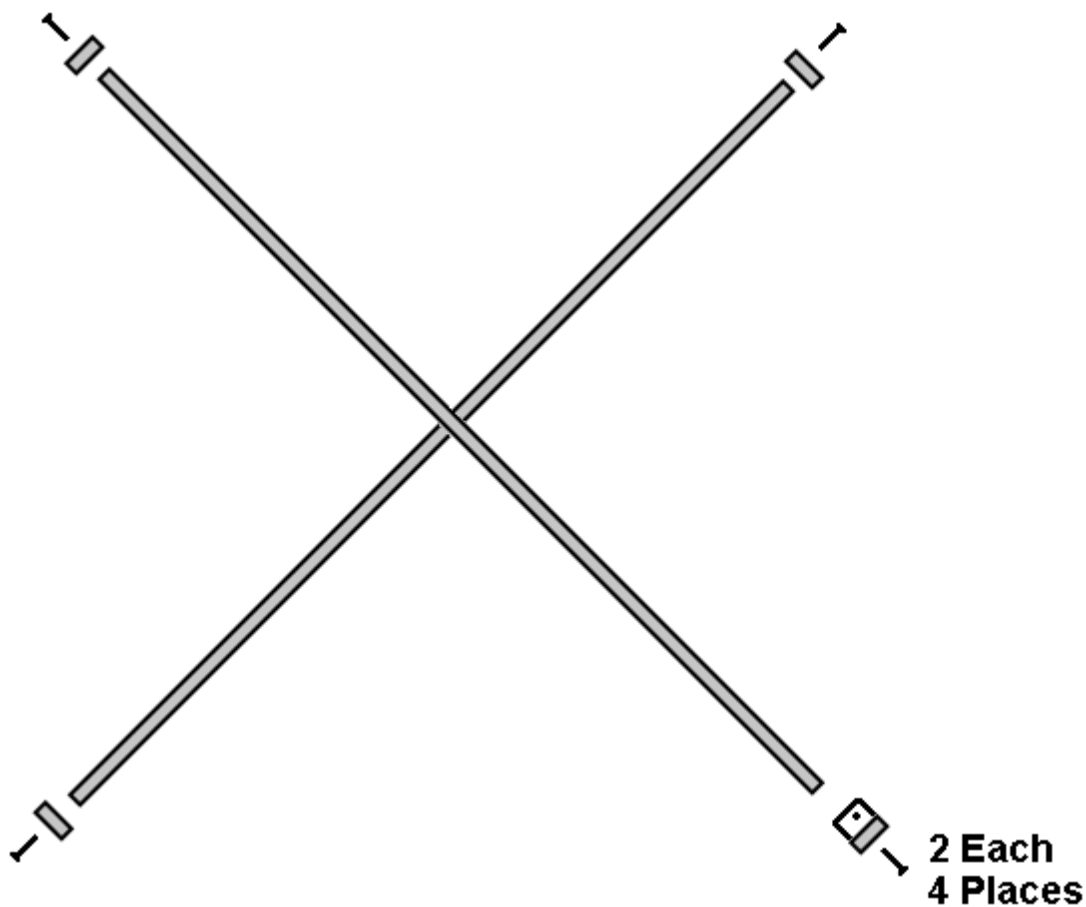

- Make a mark one inch from each end of the eight inch support blocks.

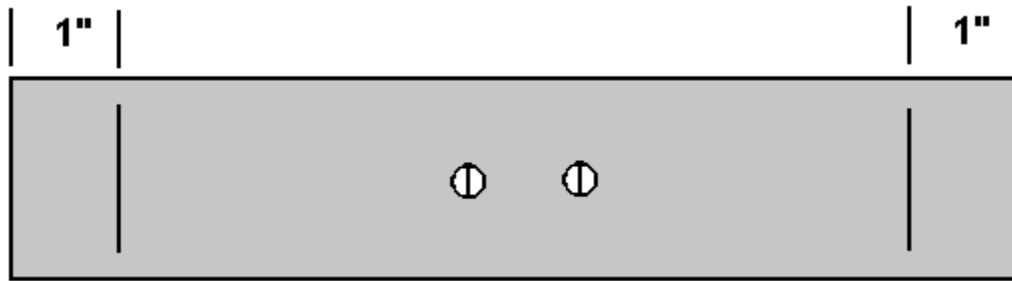

- Carefully route one end of the wire through the second hole from the tuning capacitor on the tuning block. Attach the end to the ground screw on the terminal block.

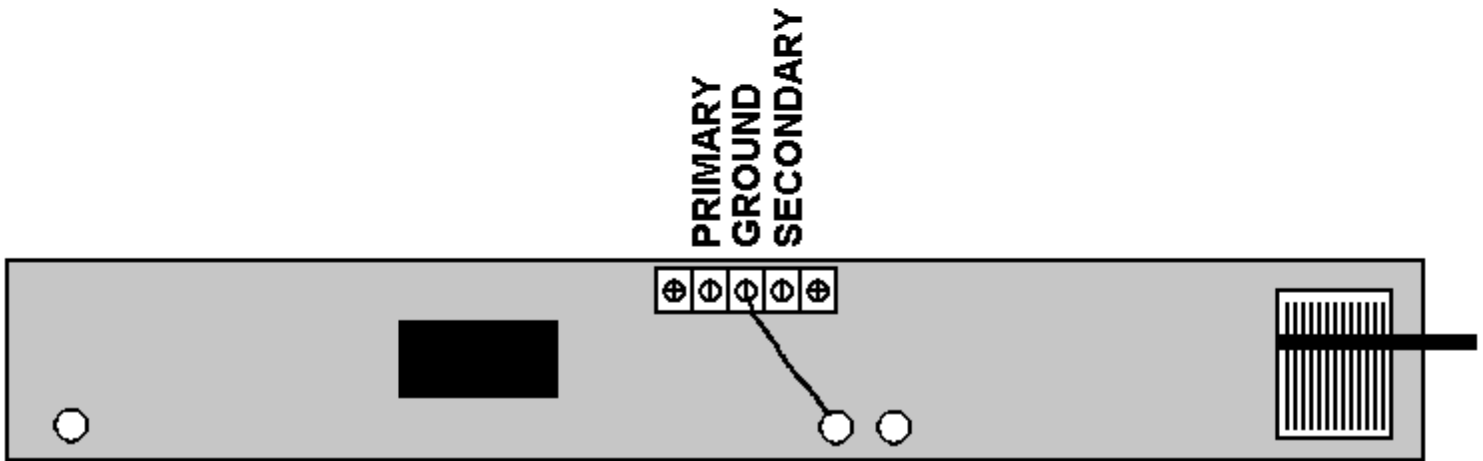
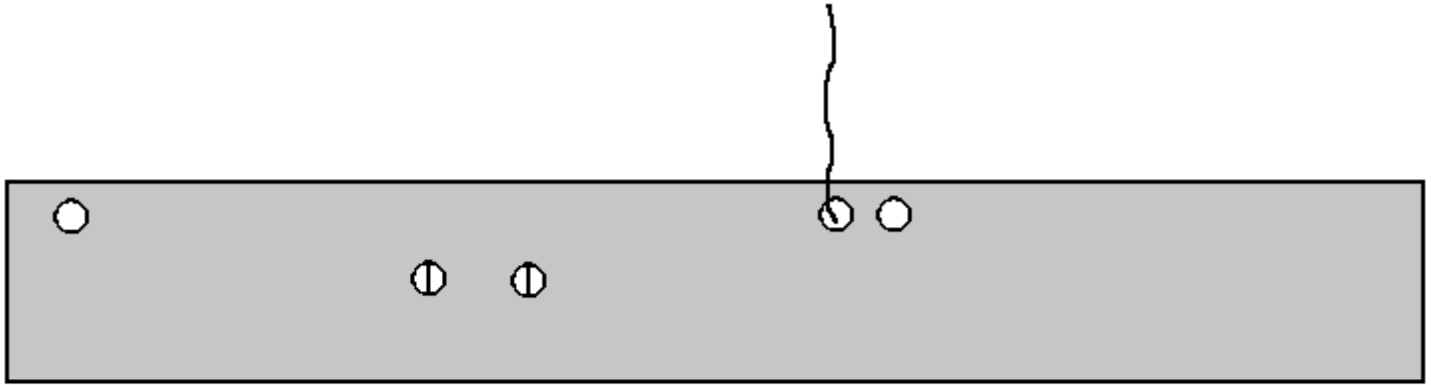

- Carefully wind 9 turns of wire around the outside of the loop. It will be quite large and unwieldy, it may be easier to place the loop horizontally on the floor and go around the loop with the spool. Keep the wire taught!

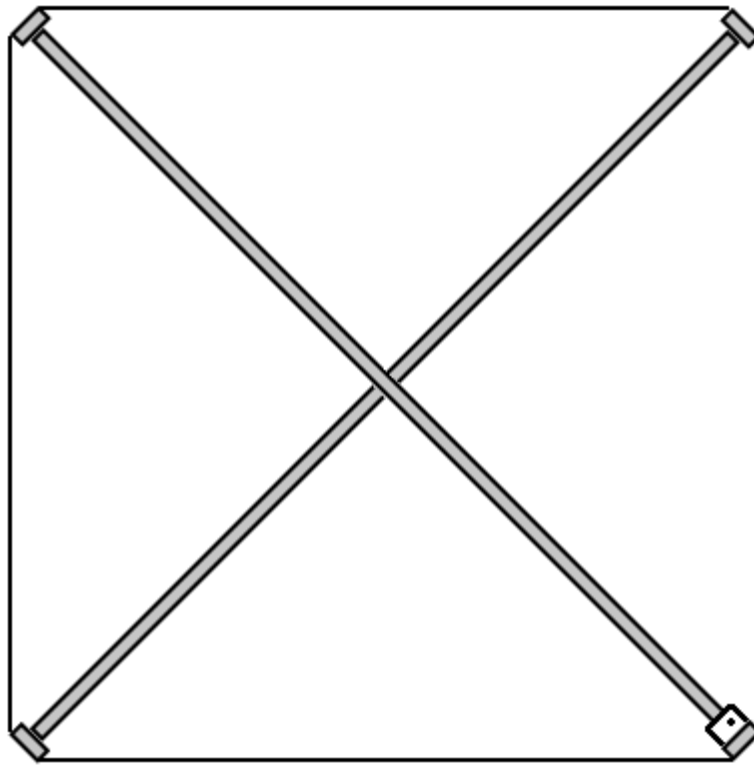

- At the end of 9 turns, route the other end free end of the wire through the end hole in the tuning block, and attach to the primary screw on the terminal block.

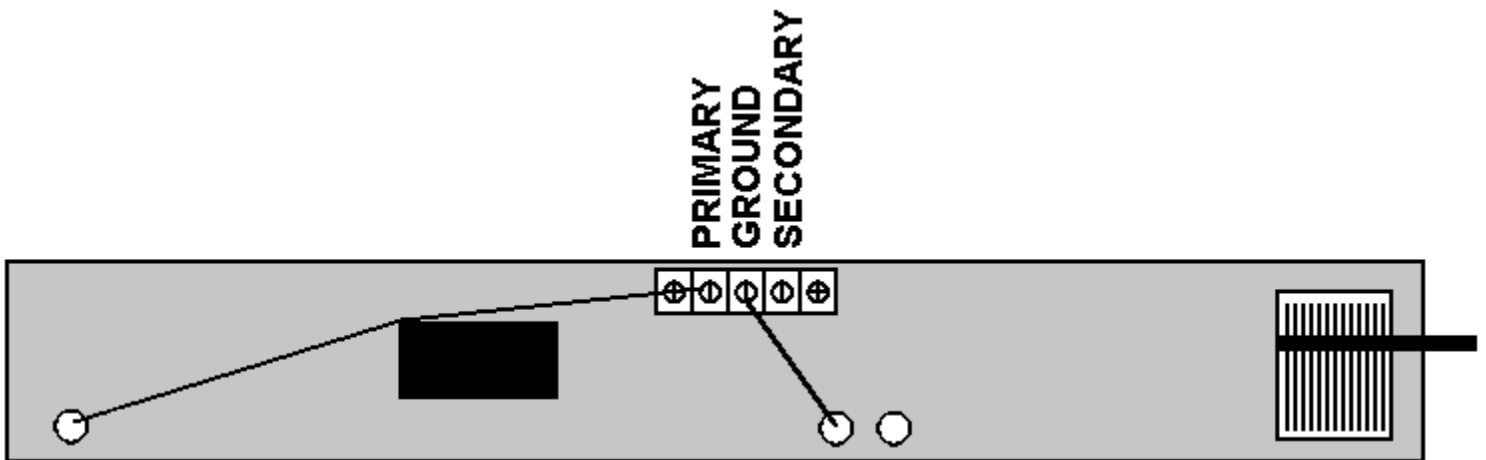
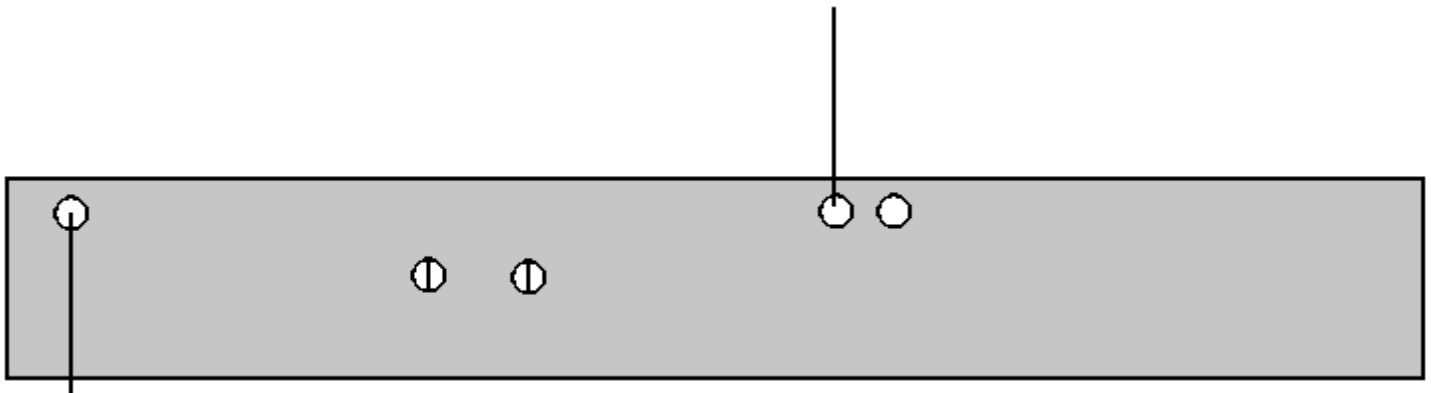

**NOTE:** Intermediate windings not shown for clarity.

- Space out the 9 turns of the winding evenly between the two marks on each support, or between the two wires on the tuning block.

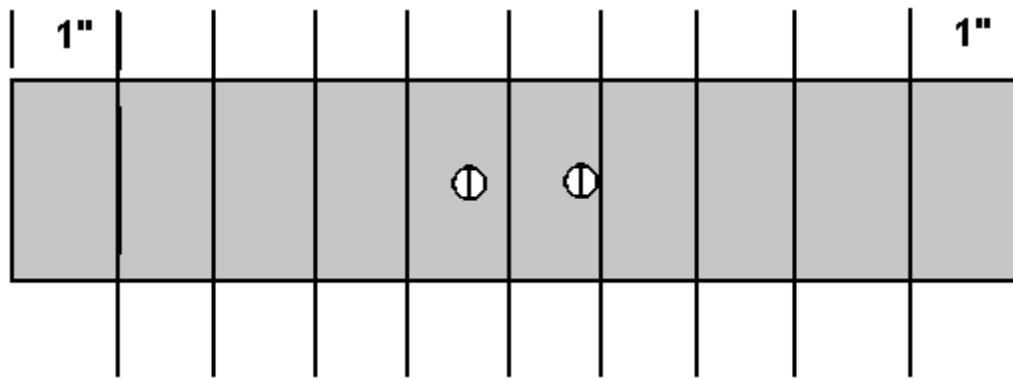

- Wind one turn of wire from the ground terminal screw, around the supports, to the secondary terminal screw.

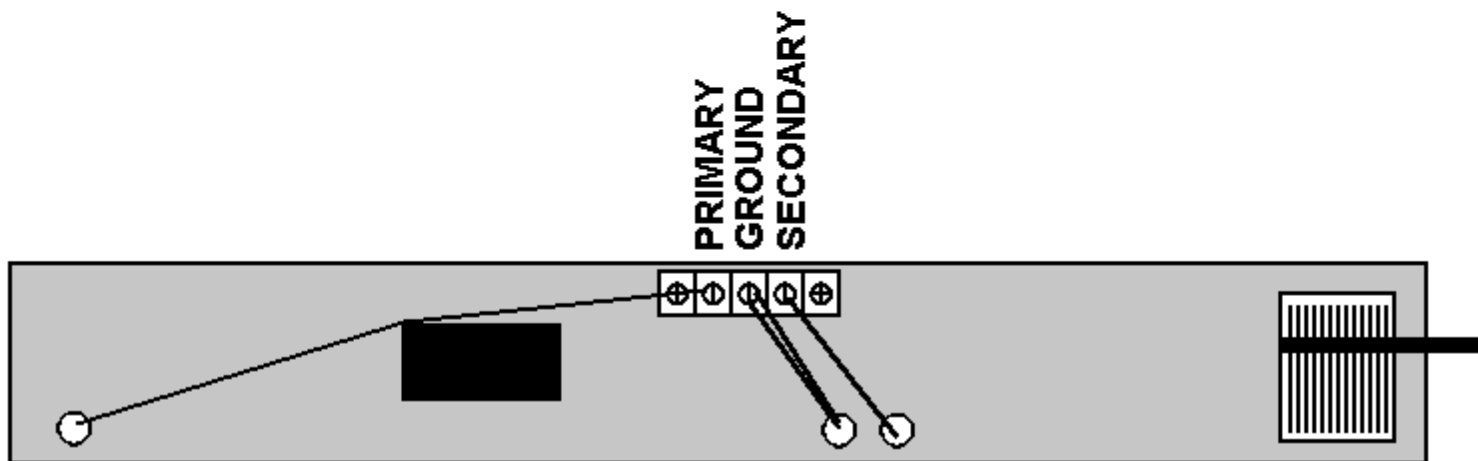
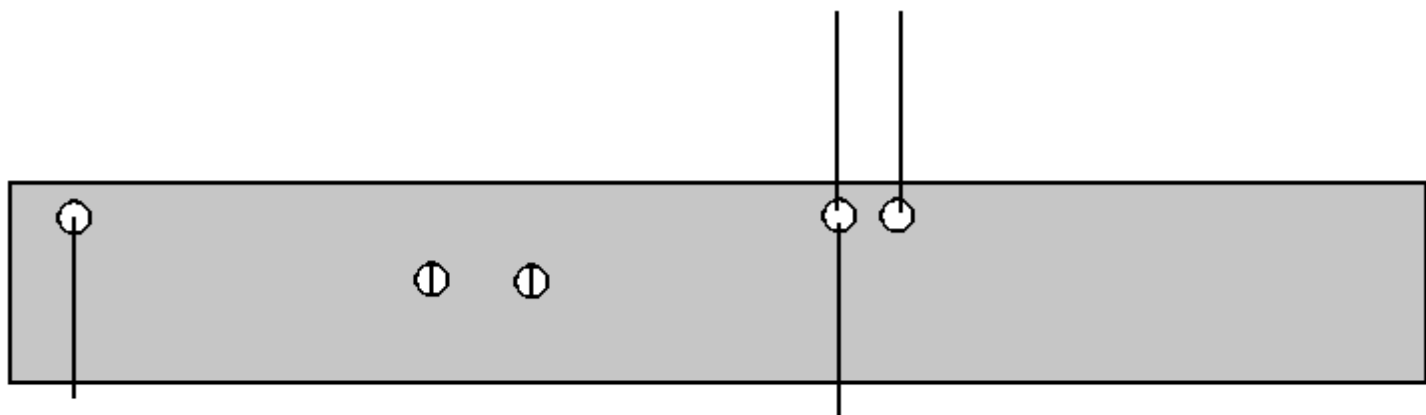

- Connect the ground of the tuning capacitor to the ground screw of the terminal block. Connect the other terminal of the tuning capacitor to the primary screw of the terminal block.

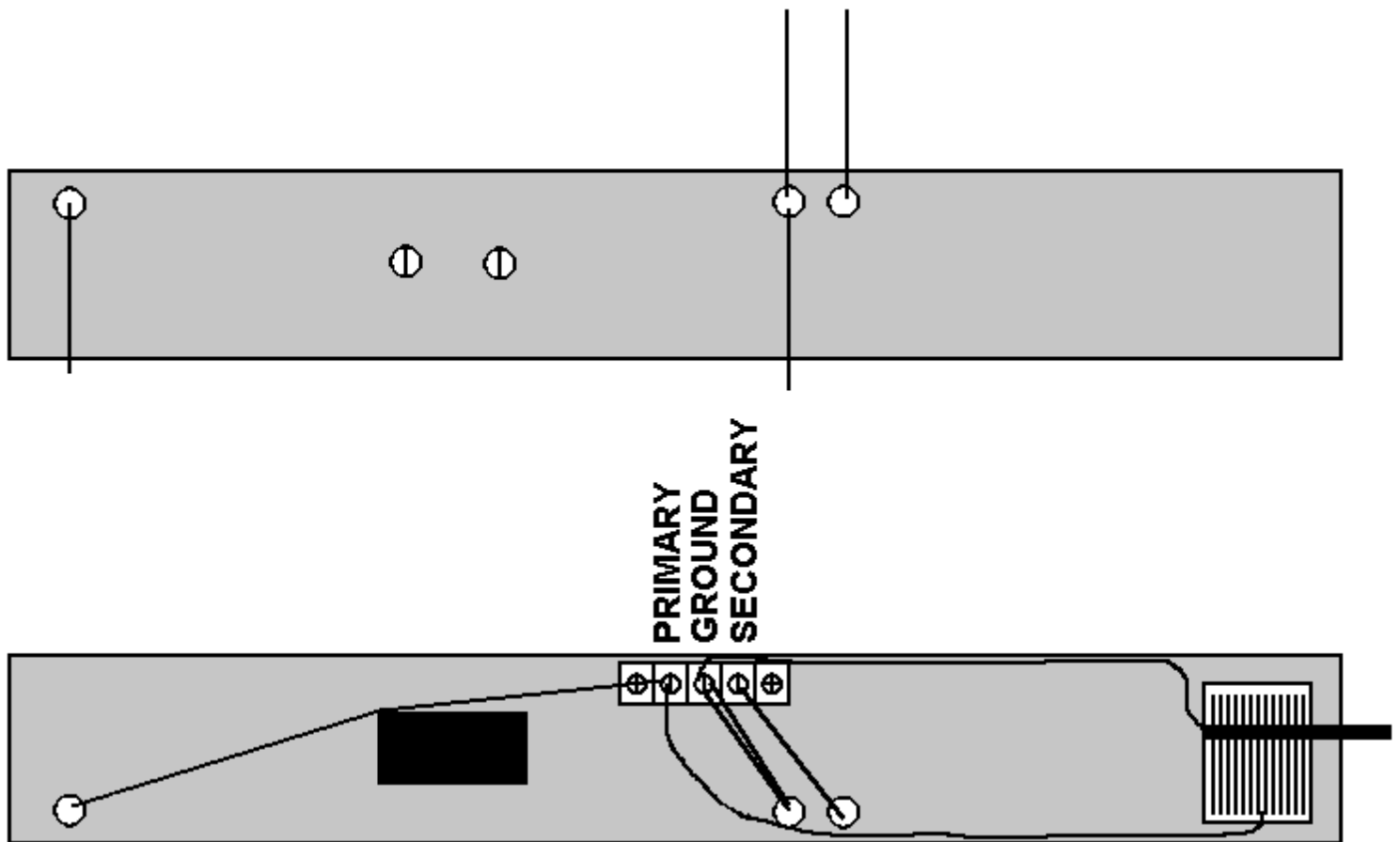

- Connect the ground terminal screw on the terminal block to the ground of the receiver. Connect the secondary screw on the terminal block to the antenna input of the receiver. Use coax or twisted pair to connect to the receiver.

If the receiver has a ferrite bar antenna, there are two methods of coupling. One is to wrap a few turns of wire around the ferrite bar at the end opposite the existing windings, and couple those windings to the coax.

Another method is to replace the ferrite bar with the loop. The tuning capacitor would not be used in this case. The ferrite bar in the radio would be removed, and the primary wired across the tuning capacitor in the radio. The secondary of the loop would then be connected to the secondary connection in the receiver (where the end wire from the small portion of the winding on the ferrite loop went). Some receivers do not have common returns for the two windings – in that case the designer needs to connect the proper grounds to their locations in the receiver.

## Test Results

The author's Dallas / Fort Worth "metroplex" location made testing impossible due to overloading and interference from local stations. A remote listening location at 33.9N, 101.9W was selected near (but not at) the antenna facility of Texas Tech University in Lubbock. This site was also selected for high ground conductivity, between 15 and 30 millimhos / m.

Three portable receivers were selected to minimize noise conducted over power lines (notoriously bad at the reception site). These receivers were a GE 7-2887A (AKA "Superadio 3"), an Optimus [12-603](#), and an Optimus 12-732. These receivers range from very good to modest.

Tests were conducted using only the receiver's internal ferrite bar antenna, a Terk "AM Advantage" 9 inch loop antenna, and the loop described in Appendix A. The Terk AM advantage does not have a frequency range to 1700 kHz. It tops out at 1600 kHz – the old limit of the AM band. Therefore, it was not capable of tuning one of the test stations.

Tests were conducted in the middle of daylight hours only – no medium wave booster is needed at night in the continental United States. The test focused on reception of Dallas / Ft. Worth area stations from Lubbock, TX; however, stations were added from different areas as appropriate. These stations are listed in Appendix B. The most distant stations were characterized by deep

fades with periods of an hour or more, so not all were simultaneously logged. The strength of the distant stations at their peak was enough that the author believes even more distant stations could also be logged. Stations were logged that do not appear here that were even more distant – however time prevented positive identification. There was not much point, since it would only serve to further validate the best combination of loop and receiver, which was the Superadio 3 and the five foot loop, as expected.

The standards of reception below are somewhat subjective, but it is possible to apply standards consistently in a single test session. The author used the following signal categories:

1. No signal
2. Carrier only - generated a 10 kHz tone with an adjacent station
3. Slight signal – audio modulation can be heard, but no intelligible words can be made out
4. Unlistenable - intelligible audio can be heard, but there is so much static and interference that prolonged listening would produce ear fatigue
5. Listenable – the audio is sufficiently good to be listened to without ear fatigue
6. Good Signal – audio is almost clear, but contains artifacts of 10 kHz tones from adjacent stations, bleed over from modulation on nearby stations, slight residual static
7. Clear – no audible interference

As expected, reception using the internal antennas yielded badly degraded and almost unlistenable audio on all but the GE superadio III:

Frequency	Call	12-732	12-603	7-2887A
540	KDFT	0	0	0
610	KSVA	0	1	2
620	KMKI	3	4	5
640	WWLS	3	3	4
650	WSM	0	0	0
660	KSKY	3	3	4
780	WBBM	0	0	0
810	WHB	0	0	0
820	WBAP	3	4	5
830	WCCO	0	0	0
850	KOA	0	0	0
870	WWL	0	0	0
880	KRVN	0	0	0
1700	KTBK	0	0	0

The Terk AM advantage antenna is an unamplified 9 inch loop antenna. The 12-732 receiver does not have an external AM antenna input. It is merely brought close to the loop windings to inductively couple signal into the internal ferrite loop. It yields some improvement, but not a lot:

Frequency	Call	12-732	12-603	7-2887A
540	KDFT	0	0	0

610	KSVA	1	3	3
620	KMKI	4	5	5
640	WWLS	3	4	5
650	WSM	0	0	0
660	KSKY	3	4	5
780	WBBM	0	0	0
810	WHB	0	0	0
820	WBAP	4	5	6
830	WCCO	0	0	0
850	KOA	1	1	2
870	WWL	0	0	0
880	KRVN	0	0	2
1700	KTBK	0	0	0

The 4 foot loop yielded dramatic improvement:

Frequency	Call	12-732	12-603	7-2887A
540	KDFT	3	5	6
610	KSVA	0	1	2
620	KMKI	6	6	6
640	WWLS	6	6	7
650	WSM	5	5	6
660	KSKY	4	4	5
780	WBBM	0	0	5
810	WHB	2	3	4
820	WBAP	5	5	6
830	WCCO	2	3	3
850	KOA	3	3	4
870	WWL	4	5	5
880	KRVN	2	2	3
1700	KTBK	0	2	4

The large loop allows many distant stations to be heard on even a modest receiver. As expected, receivers have personalities, related to the number of IF stages, the presence or absence of a tuned RF stage, and particularly the AGC characteristics. A good example is the reception of 780 on the 7-2887A (Superadio 3). The other two receivers are manufactured by Radio Shack, and therefore have some selectivity and AGC characteristics in common. 780 kHz was unreceivable on the Optimus receivers at the test location due to the presence of a local station on 790 kHz. When the Radio Shack receivers are tuned, strong local stations have a strong presence even 30 to 40 kHz away from the center frequency, and are much louder in volume. In spite of



this, the 12-603 appears to be more sensitive on a few stations. It also allowed reception of 620 kHz in the “wide” position, providing high frequency response without a large increase in noise. When the “wide” position was attempted with the Superadio 3 on 620 kHz, the volume decreases markedly. The “wide” position may have more bandwidth on the Superadio 3 than it does on the 12-603. The reception of KMKI would have rated 7 on all three receivers, had it not been for a strong source of local noise. Volume on the station increased dramatically as the loop was tuned to 620 kHz.

Stereo reception was not attempted on the three receivers, because they did not contain an AM stereo conversion circuit. In practice, however, the better the signal quality, the better the chance of satisfactory stereo reception.

## Tru-isms and Other Observations

If there was a single result of this test, it was to confirm certain facts that are self-apparent, but seldom questioned. These facts are listed below:

- Better quality receivers have the capability of more distant reception than modest receivers.
- Receivers with tuned RF stages are more sensitive. Two of the receivers used in this test have tuned rf stages – the 7-2887A (Superadio 3), and the 12-603. This is not the complete story, however, as the 12-603 had a lot more in common with the 12-732 than it did with the 7-2887A.
- Larger antennas receive more stations than small ones. The Terk AM advantage 9 inch loop helped the modest 12-732 and 12-603 receivers far more than it helped the Superadio 3. When connected to the Superadio 3, it did not produce much change at all, but the 5 foot loop produced a large change. The area of the loop is the determining factor for reception for open-air box loops,
- The length (and diameter) of the ferrite bar is the determining factor for reception for internal ferrite bars. Longer and thicker is better.
- Low AM frequencies propagate much better than high AM frequencies. KMKI on 620 kHz had a much better signal that did WBAP 820 kHz, even though WBAP broadcasts with ten times the power and is 30 miles closer to the test location. There was another Dallas station on 570 that could have been used as a test station, but the presence of a strong signal in Lubbock on 580 prevented reliable reception, even on the Superadio 3. The station of 570 was present and would have otherwise been very clear. The author did not have access to the Texas Tech antenna facility for the writing of this article, but more than 20 years ago logged the Dallas 570 frequency with a Hammarlund SP-600 JX in the 3 kHz IF bandwidth position at that facility. The author now has a Hammarlund SP-600 JX receiver of his own, but it weighs 70 pounds and is not a good candidate for hauling across the state for a test of this nature.

Constructing two loops of different sizes invites comparisons. Direct performance comparisons could not be made, because the [2 foot loop](#) was tested in the Dallas instead of the remote site listed above. As expected, DX opportunities were limited by overloading on strong local stations. Some interesting facts, however, did come to light:

- The winding spacing, which was so critical on the four foot loop, hardly mattered at all on the two foot. This explains the results I got with the Terk AM advantage, which did not have any loop spacing at all - except for the miniscule spacing caused by the clear coating on the magnet wire.
- The two foot loop did not seem to be very effective at catching really distant DX. Granted - the time of year was different by three months, which could have something to do with it.
- The two foot loop was very effective with the low cost receiver, and not so effective with the SR-3. This is no surprise, since the four foot loop was also limited in effectiveness with the SR-3.
- The high frequency tuning on the four foot loop was very fuzzy and indistinct. It improved on the two foot loop.

## Appendix A: Test Stations for the Four Foot Loop

Frequency	Call	Power (kW)	Latitude	Longitude	Distance Miles	Distance kM
540	KDFT	1	35.2	97.3	343	556
610	KSVA	5	35.0	106.4	268	434

620	KMKI	5	33.1	96.3	328	531
640	WWLS	5	35.2	97.3	277	449
650	WSM	50	35.6	86.5	883	1430
660	KSKY	10	32.5	96.4	333	539
780	WBBM	50	41.6	88.0	926	1500
810	WHB	50	39.2	94.3	943	1528
820	WBAP	50	32.3	97.1	328	531
830	WCCO	50	45.1	93.2	901	1460
850	KOA	50	39.3	104.4	397	643
870	WWL	50	29.5	90.0	763	1236
880	KRVN	50	40.3	99.2	466	755
1700	KTBK	10	33.2	96.3	327	530

# The Two Foot Loop

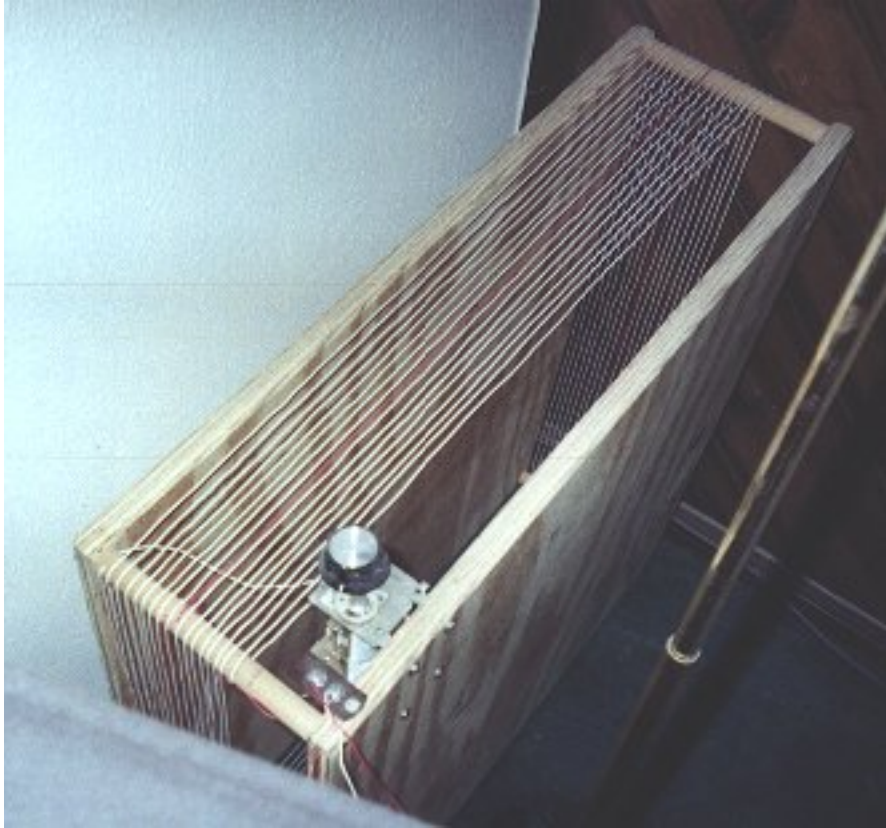

The two foot loop nestled in a space against the wall, in back of my speaker and beside a lamp.

## Materials

A four foot by two foot piece of plywood discarded by a neighbor prompted a project - a two foot loop. Additional materials required were:

- A 2 foot length of 5/8 inch dowel.
- 150 feet of #20 guage solid wire. The discarded conductor of the twisted pair doorbell wire used for the 4 foot loop was still available, and worked well. The reader who downloads the spreadsheet will notice that I include a calculation of the length for the main loop. The length is not fixed, as one reference suggests, but it is nearly constant for a number of loop antennas in the middle of the range. The length increases at the extremes.
- A 9.6 to 365 pF tuning capacitor – the large set of plates in a tuning capacitor salvaged from a junk radio. The 2 foot loop described here made use of a 9.6 to 500 pF capacitor, and part of the range is unusable.
- 8 wood screws.

# Construction

Admittedly - this description is brief. Anyone who has read through the article on constructing the four foot loop should have the idea by now ---

- Cut the 4 foot by 2 foot piece of plywood into two equal 2 foot by 2 foot pieces.
- Cut four 6 inch sections of dowel.
- Drill 4 holes in each corner of both pieces of plywood, 5/16 by 5/16 inch in from the edges.

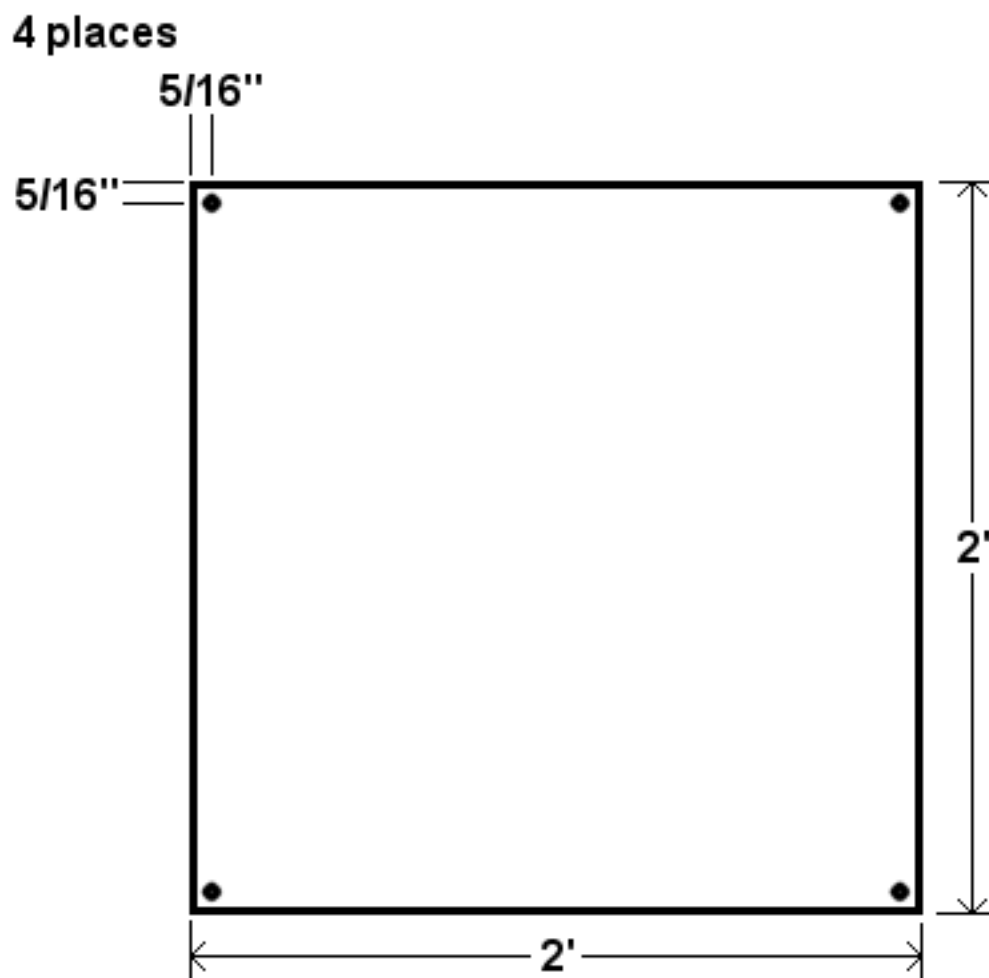

- Form the box by screwing through the holes in the corners of a piece of plywood into the end of the four pieces of dowel. It helps to pre-drill a pilot hole into the dowel. Otherwise - it has a tendency to split. Attach the other piece of plywood in the same way. The resulting structure is strong, but resist the temptation to lift it by the dowels.

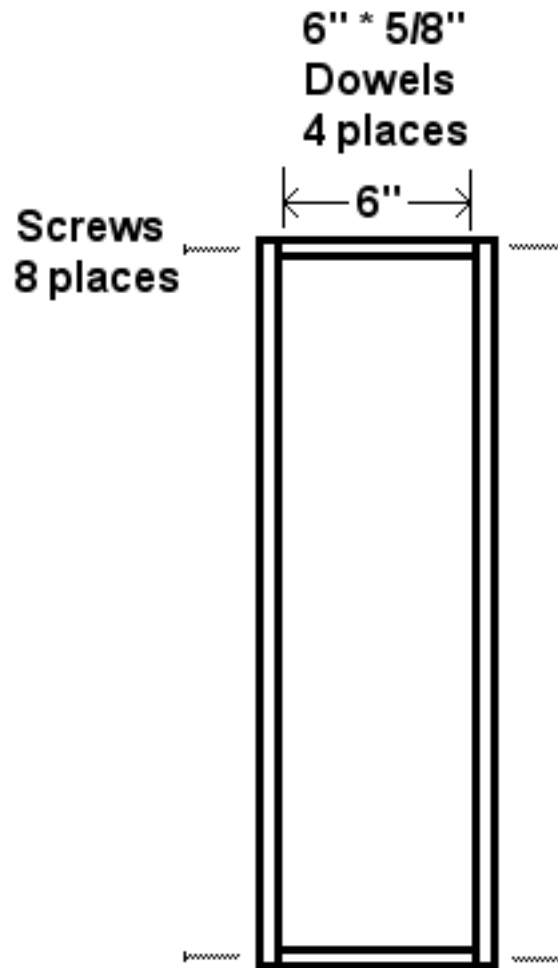

- Mount the tuning capacitor to the inside of one of the pieces of plywood, near one corner, but not where it would interfere with the mounting of a dowel.

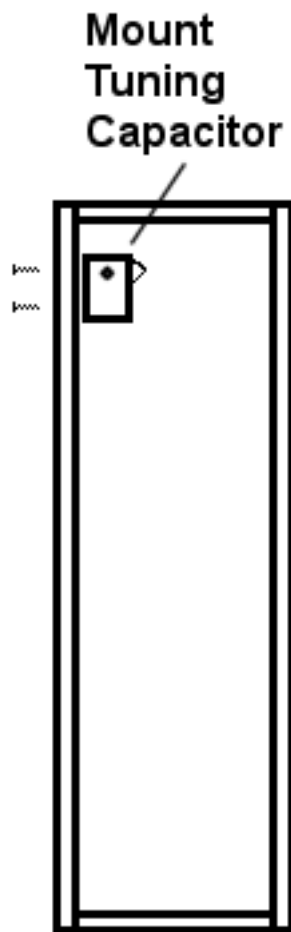

- Wind 16 turns of wire on the dowels - space them out to occupy 4 inches of length on the dowel.

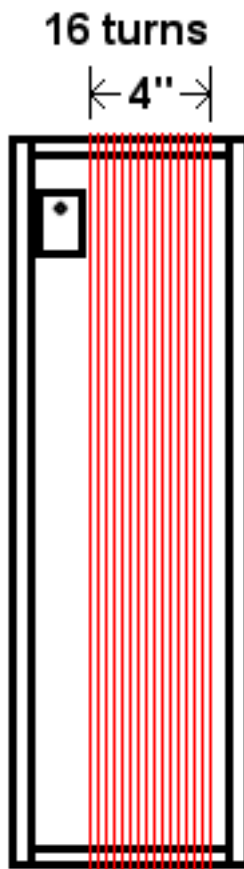

- Wind a single turn of wire between turns 8 and 9 of the main loop.

one turn  
sense  
winding

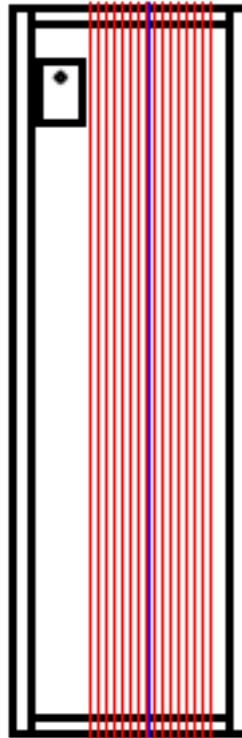

- Make the indicated connections.

### CONNECTIONS

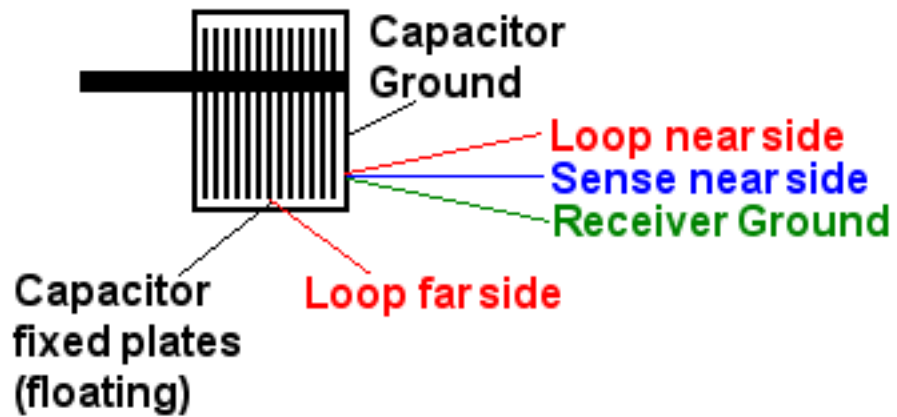

Receiver antenna input ————— Sense far side

## Test Results



As expected, the loop tuned almost the full AM band. It topped out, however, at 1650 kHz. There was some benefit, however on a weak station on 1680 kHz. Both the [UMR EMC lab](#) and [Joe Carr](#) calculators seem to indicate that it is easy to cover the entire AM band. Neither loop tested, however, can go anywhere near 3 MHz. This may be due to self capacitance of the windings. It is probably possible to tune the whole band by switching in an out a single turn of the loop. At some point, this will be tried and the results posted here. The wide range of the tuning capacitor may make it possible to leave out that turn permanently.

The low end of the AM band tuned when the capacitor was opened to approximately the 365 pF position.

There are weak stations in the DFW area on 550, 590, 600, 640, 680, and 750 kHz. There are also many weak stations located higher on the band, including some TIS stations from DFW airport on 1640 and 1680 kHz. Reception on weak stations improved markedly on the inexpensive receiver - some signals that were not present at all, like the TIS stations, appeared and were listenable. Reception improved slightly on the SR-3. The greatest effect was on more distant stations, and those like 550 kHz that are closely spaced to local stations. The presence of a tuned loop increasing signal strength on the distant signal had the effect of overriding the adjacent channel interference. This advantage alone would be enough to justify the use of the loop in the DFW area.

# The Folding Loop Antenna



Folding loop antenna - deployed.



Folding loop antenna - folded.

## Introduction

In my study of AM Box Loop Antennas, I have quickly realized that no matter how good the reception improvement may be using a loop - the loop antenna itself is large and cumbersome. This limits its usefulness to home installations. The large loops do not lend themselves to portability. How can that be changed?

As a teenager in Midland, TX, I brought the best radios available to the pool where I spent many a lazy summer afternoon. No matter what I tried, good radio stations such as KLIF Dallas was just too weak. Even WFAA, during its short career as a top 40 station, was so weak that I

had to turn the volume control all the way up just to hear the signal. I wish I had known about loop antennas at the time, but more than that - I wish I had invented a "folding loop", one that would be easy to carry in, quick to set up, yet not compromise the performance of a large loop in any way.

Now, 25 years later, I am faced with a similar situation. My daughter loves to listen to "Radio Disney" - KMKI, a 5000 Watt AM station on 620 kHz from the Dallas area. She wants to hear it when she visits grandad in Lubbock, TX 330 miles away. And she wants to hear it at a pool in the neighborhood where he lives. To her, all that matters is the music. It must be clear. What we carry to the pool must be a convenient size, light weight, easy to set up, and quick to adjust. It must work the first time, there is no time for tinkering - and it must be reliable. A perfect application for a "folding loop".

I know that one company makes a "pocket loop" - no doubt taking advantage of the spring characteristics of their loop antenna structure to allow it to be twisted into a smaller shape - similar to some automotive shades. Good idea, but I bet the things get tangled after a while - like a slinky. Their unit costs about \$150, making it a lot more serious problem once it does get tangled!

So - with twisting coils not an option, what else could I try? Some 27 inch shelves discarded from a home entertainment system provided the answer.

## Materials

To construct the folding loop, it is necessary to procure the following material:

- Five 27 inch lengths of 1 by 8 lumber (the actual size of 1 by 8 lumber is 11/16 by 5 1/2 inches).
- Ten small hinges and their mounting screws. I found some brass furniture hinges at Home Depot that were perfect. They must be small to avoid interfering with the loop tuning.
- Four small 5 1/2 inch long blocks of wood. 1 by 1 lumber scraps are perfect.
- Eight 1 inch wood screws.
- 150 feet of #20 guage solid wire. Probably the cheapest source is thermostat or doorbell wire, which comes as insulated twisted pair. Simply measure the length of both of the wires, and then take one conductor of the two for the loop. The other conductor can then be used as the secondary wire, or for other purposes. Another source of wire is discarded telephone or network cable – simply splice sections together to make the desired length. These types of wire, however, will give poor results – particularly at the high end of the band. Multi-stranded antenna wire is better.
- A 9.6 to 365 pF tuning capacitor – the large set of plates in a tuning capacitor salvaged from a junk radio.

# Construction

Click on the pictures to see them full size ---

- Connect two of the pieces of 1 by 8 lumber together at the edge with two hinges.

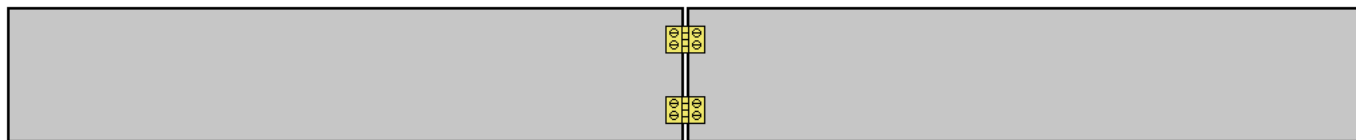

- Continue to connect pieces of 1 by 8 lumber with hinges at the edges until 4 pieces have been joined.
- Connect the fifth piece of 1 by 8 lumber to the side of the first piece with two hinges.

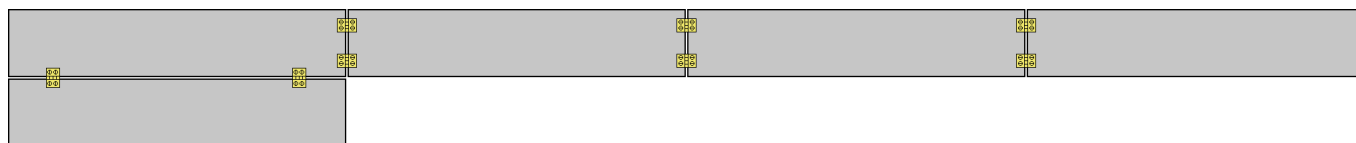

- Attach the tuning capacitor to the exposed edge of the fifth piece of lumber.

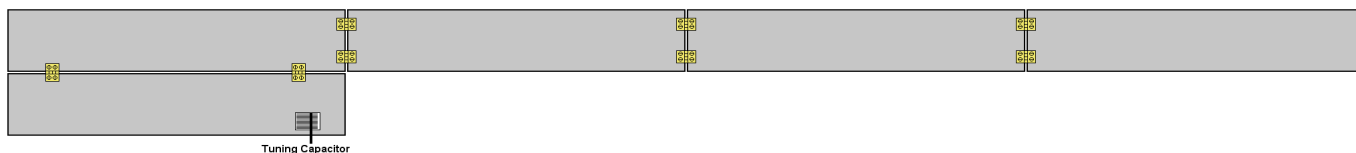

- Fold the 4 pieces into a square shape, and place two additional hinges to connect the end pieces together and complete the frame.

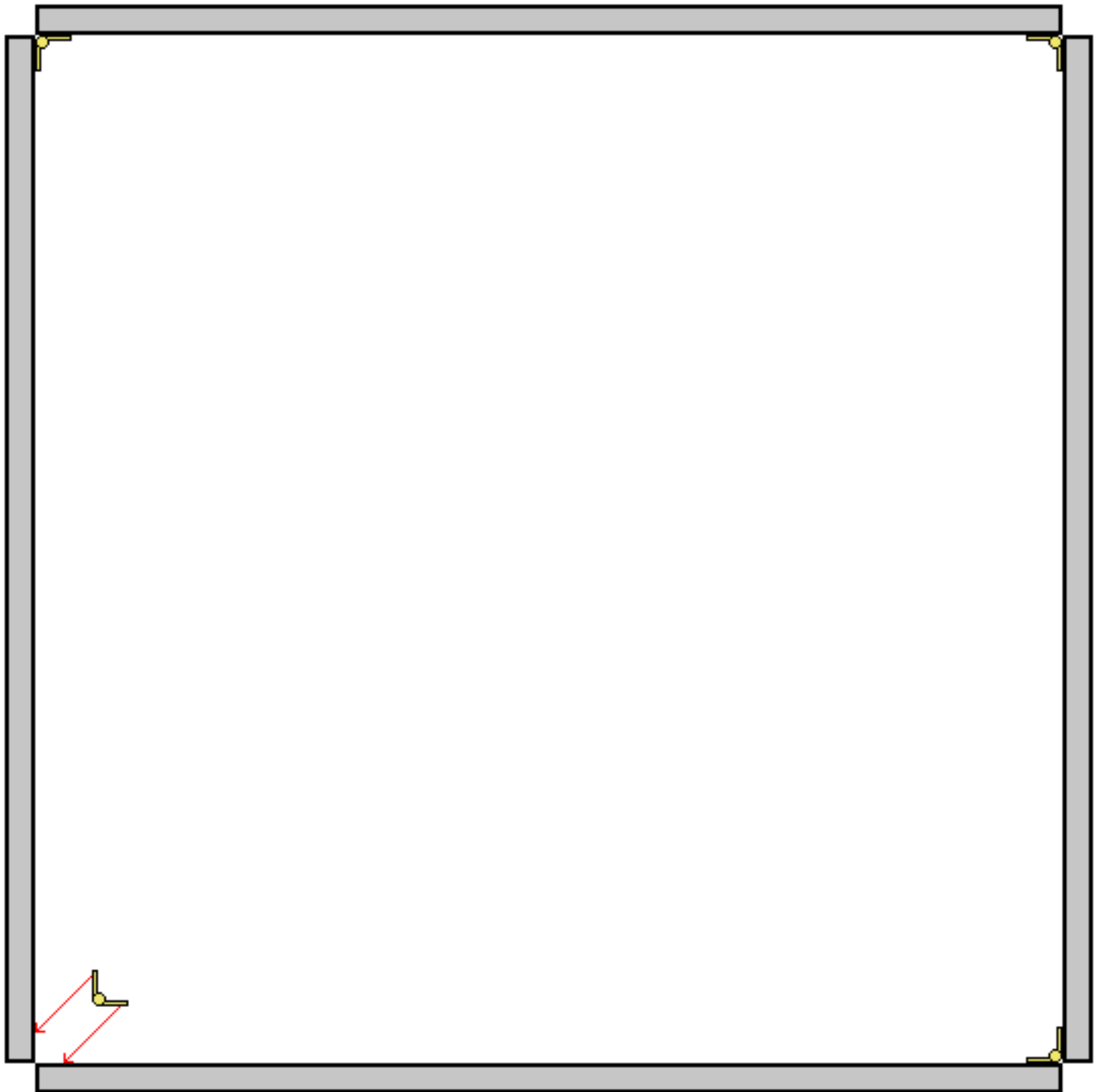

- Fold the tuning capacitor piece of lumber in towards the center of the loop, making sure the edge is inside the top and bottom pieces of the frame. This will support the frame in a square shape - the shape used by the loop when it is in use. When not in use, the tuning capacitor piece is folded back, which allows the loop to collapse for storage.

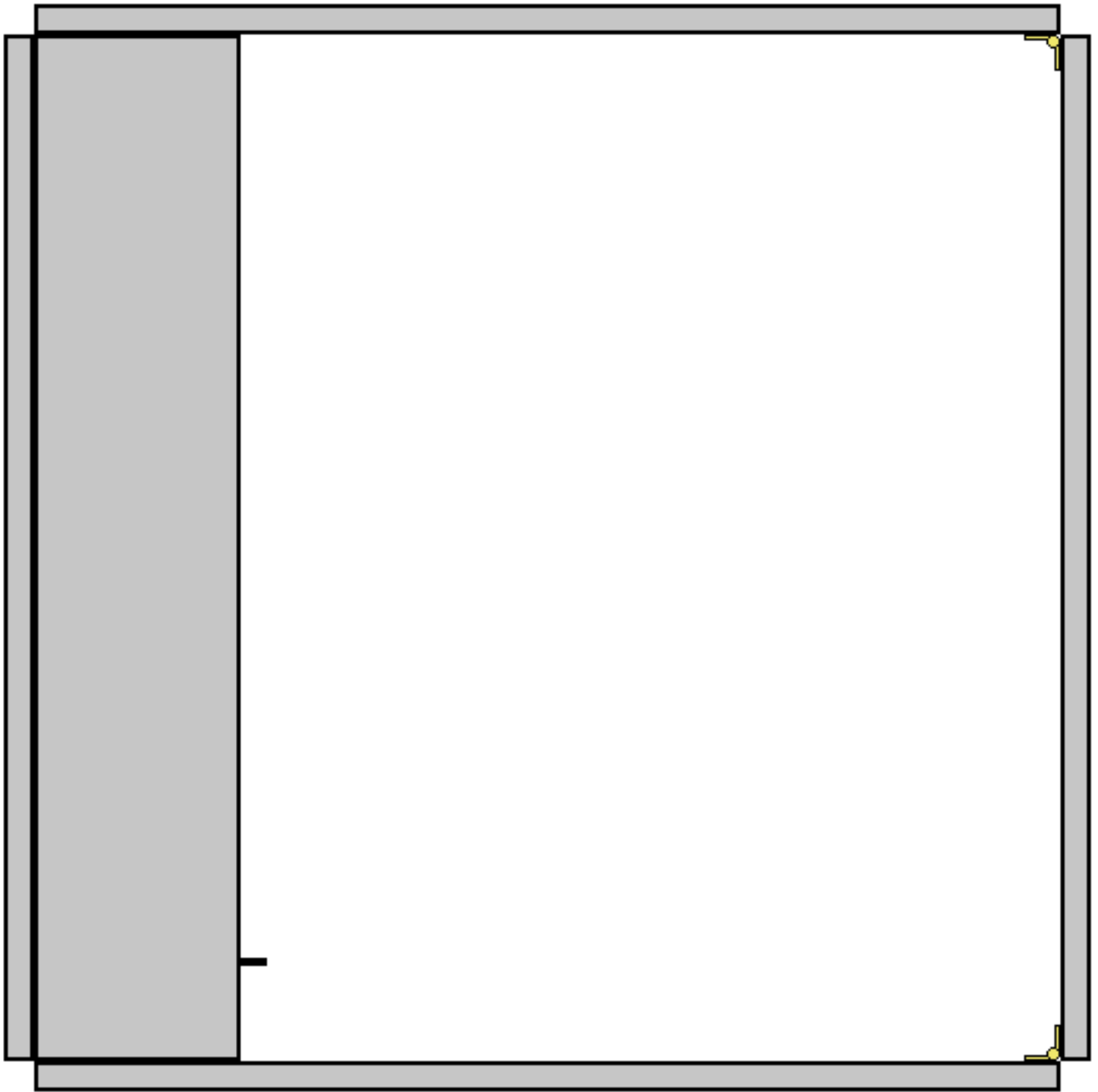

- With the loop in its "in use" shape, as a square frame - wind thirteen turns of wire on the frame. The exact spacing is not terribly important as it has little impact on the inductance of the loop, but the windings should be spread out equidistant from each other.

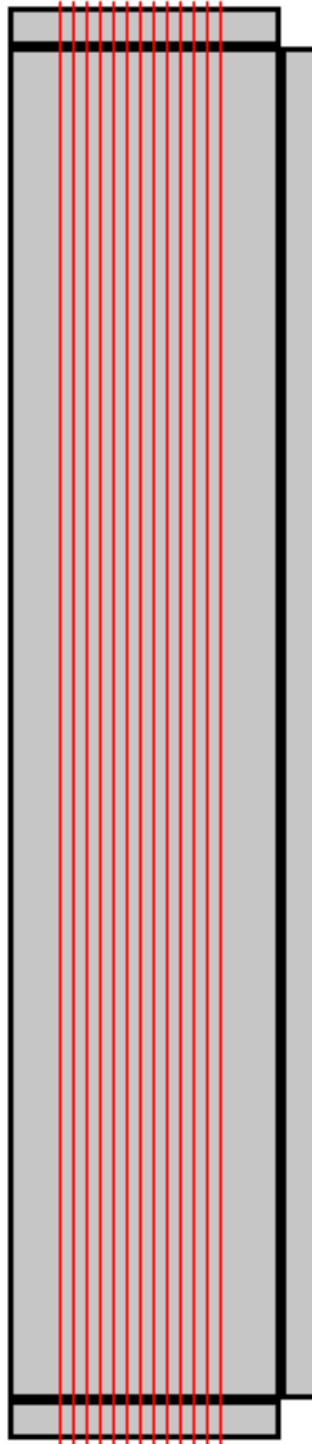

- Prepare 4 pieces of 1 by 1 wood, cut to 5 1/2 inches long. With a saw blade, notch each piece 13 times. A good way to measure the location of these notches is to put it against the turns on the loop, and marking with a pencil. Drill 2 holes on either side of winding notches.



- Screw the pieces of wood over the windings near each hinge joint, making sure the wires

slide freely through the notches. It is not necessary to have a piece of wood on each side of the joint, but it would not hurt anything. The purpose of these pieces of wood is to support the wire when the loop is collapsed. When the loop is collapsed, the wire goes slack.

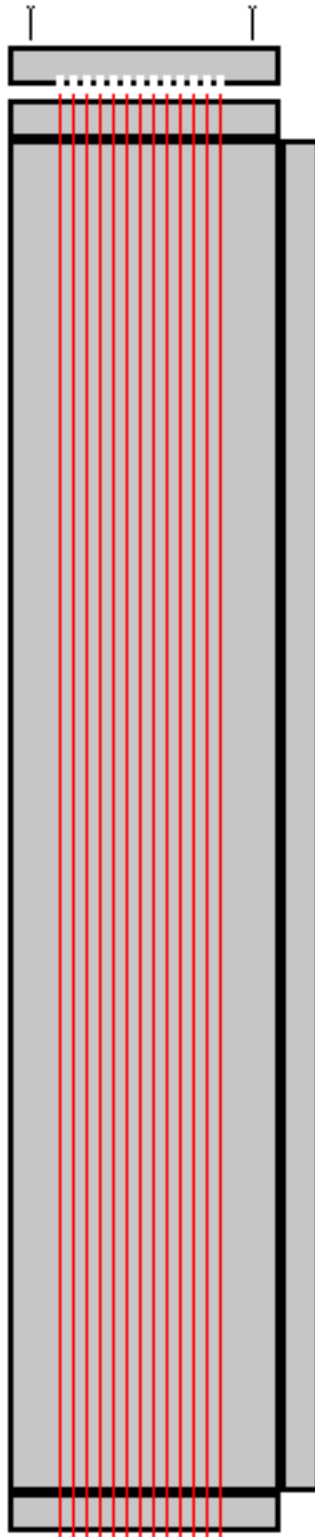

- Connect one end of the winding to the ground terminal of the tuning capacitor, the other end of the winding to the other terminal of the tuning capacitor.



- A single turn "sense" winding can be added to the outside of the loop, if an additional notch is added for it.

The end result is a odd looking contraption when folded, 54 inches long, about 11 inches wide half of its length, and 5 1/2 inches wide for the other half. It has droopy wire hanging on it, and has a tuning capacitor sticking out. It is long enough to be slightly inconvenient, and heavy enough to be slightly annoying - but the weight can be reduced by changing the thickness of the wood, 1/4 inch plywood, perhaps.

You are sure to get a few stares walking into a public area such as a pool with this contraption, but as long as you re-assure anxious lifeguards that you have no intention of taking it into the water as a "surf board", you should be fine!

If the receiver has a ferrite bar antenna, there are two methods of coupling. One is to wrap a few turns of wire around the ferrite bar at the end opposite the existing windings, and couple those windings to the coax. The other is to simply get the radio close to the loop.

Actual tests of the loop have shown that it suffers from a low "Q" - the same as the four foot loop. I have yet to solve this problem, but suspect it has a lot to do with the quality of the tuning capacitor and the wire used. The doorbell wire has over an ohm of resistance over 12 turns - I had to remove a turn because I had a 500 pF tuning capacitor instead of a 365 pF. I suspect that wire with lower resistance would improve performance considerably. Even with the low Q - it improves reception of inexpensive receivers to a great degree. Better quality receivers are not improved as much.

# The Portable 3 Foot Ribbon Cable Loop

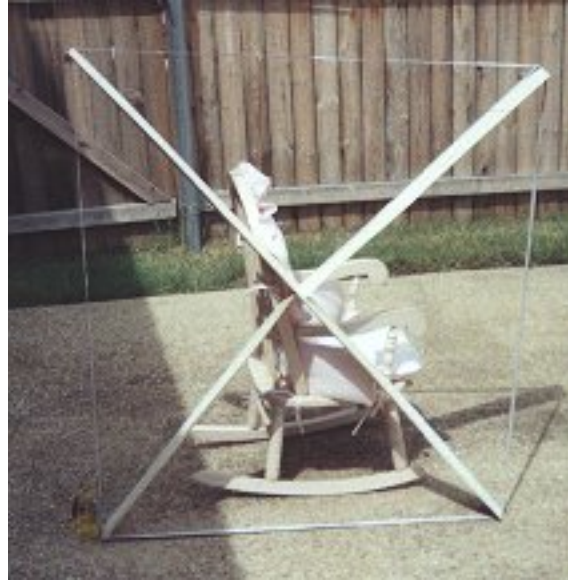

The three foot ribbon cable loop assembled, propped up by a child's rocking chair - it is not self supporting. This is a very "hot" design - excellent "Q" and excellent sensitivity.



The three foot ribbon cable loop dis-assembled, and ready to transport.

## Introduction

One idea that has been suggested for constructing a loop is to use ribbon cable, with a winding spacing of 0.050 inch, to construct the loop. I saw a loop antenna article at one time that recommended the use of flat ribbon cable, and showed how to make a loop by using the ribbon cable, offset by one pin, on two "D" style connectors, and plugging together to form the loop. I have never seen that article again, so I suspect it has been removed from the web. So I thought I would resurrect the idea.

This article describes how to construct a loop from ribbon cable. The [folding loop](#) article describes a portable loop, but I was not very happy with it. In its folded position, it was too long to throw into the back of my van to take to my remote test site. It is also heavy, and suffered

from a low Q that also plagues my [four foot](#) loop. For that trip to the pool I described in the folding loop article, I need something even better! This time, I will add the requirements that the portable loop be lightweight, and that it will not be long - like the folding loop in its folded configuration. I also will not test any loop that suffers from low Q.

I looked around for lightweight materials from which to construct a loop. They also have to be non-metallic, which limits the selection quite a bit. Some discarded vertical blinds offered me the answer. The vertical blind slats are about 84 inches long and 3 1/2 inches wide, and have a slight curve. Individually, they are much too weak to work as a support, but the slight curvature can be used to create a fairly strong support structure.

## Materials

To construct the portable loop, it is necessary to procure the following material:

- Four of the plastic blinds from a discarded set of vertical blinds. They should be the curved plastic type - not metal or wood.
- Construction quality masking tape. I am talking about the type used to tape windows up for hurricanes - which is where I got mine. I used to live in Florida, and had a roll left over. This tape is about two inches wide, and has good adhesive. That little cheap 3/4 inch stuff sold in art stores will NOT do!
- 12 1/2 feet of ribbon cable - the 25 conductor stuff will do fine, and you can make a couple of loops out of it.
- Small shrink wrap tubing.
- A 9.6 to 365 pF tuning capacitor – the large set of plates in a tuning capacitor salvaged from a junk radio.

## Construction

Click on the pictures to see them full size ---

- Cut the four plastic blind pieces to 52 5/8 inches long. Save the discarded pieces.

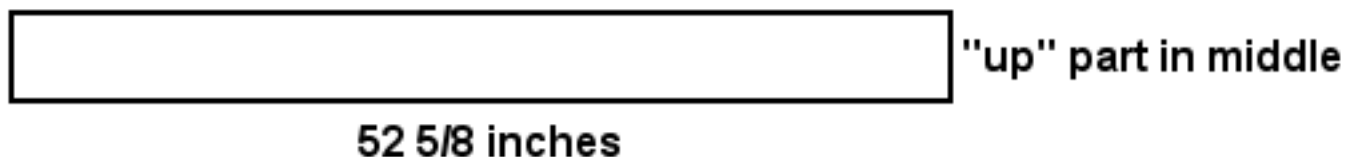

- Place the blind on the work area, with the curved part "up" in the middle. Place masking tape along both edges of one of the blinds, leaving the sticky part about half exposed.



- Turn the blind with the tape over, and place a second blind over the first, again with the curved part "up" in the middle. Fold the tape up and over both edges.



End on should look like this: 

- Repeat the process with two more plastic blind pieces. You now have the two cross braces for the loop.
- In order for the cross braces to interlock, it will be necessary to cut notches halfway through them in the exact middle, or 26 3/8 inches from the end. The width of the notches is determined by measuring the thickness of the middle part of the cross brace, but is probably about 3/8 inch. Cut the notches with heavy duty scissors or tin shearers. If regular scissors have to be used, it may be necessary to separate the two blinds and cut them individually.



- Prepare two one foot sections of blind material from the discarded pieces. Cut two 12 inch by 1 1/4 inch sections from those one foot sections.
- Tape the pieces that you just created onto the braces on the un-notched edge in the middle, one piece on each side. These pieces will compensate for the weakness created by the notch.



- Prepare a 12 foot, 5 inch piece of ribbon cable. It only has to be 7 or 8 conductors wide. Strip and tin each conductor on both ends of the ribbon cable.
- Make sure there are no "kinks" or twists in the ribbon cable, and match up the two ends so they can be worked with in close proximity. Slide short lengths of shrink wrap onto the wires on one side of the ribbon cable. Solder conductor number TWO of one end to conductor number ONE of the other. Solder conductor number THREE of the first end to conductor number TWO of the other. Continue this pattern until all but one wire on both ends have been soldered. You should be left with conductor number one of one side loose, and the last conductor of the other side loose.

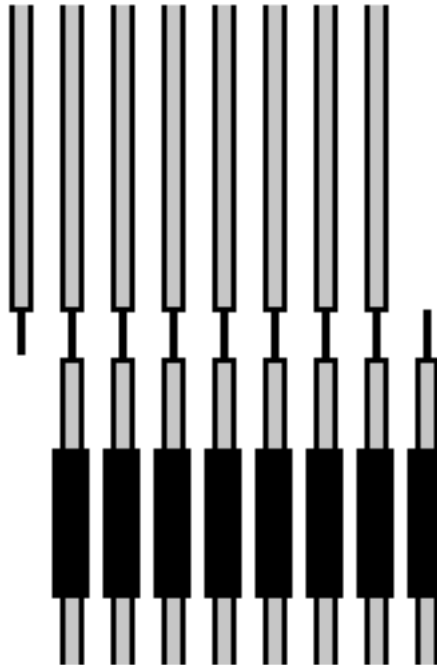

- Connect conductor 1 of the ribbon cable to the ground terminal of the tuning capacitor, the other end of the other side to the other terminal of the tuning capacitor.

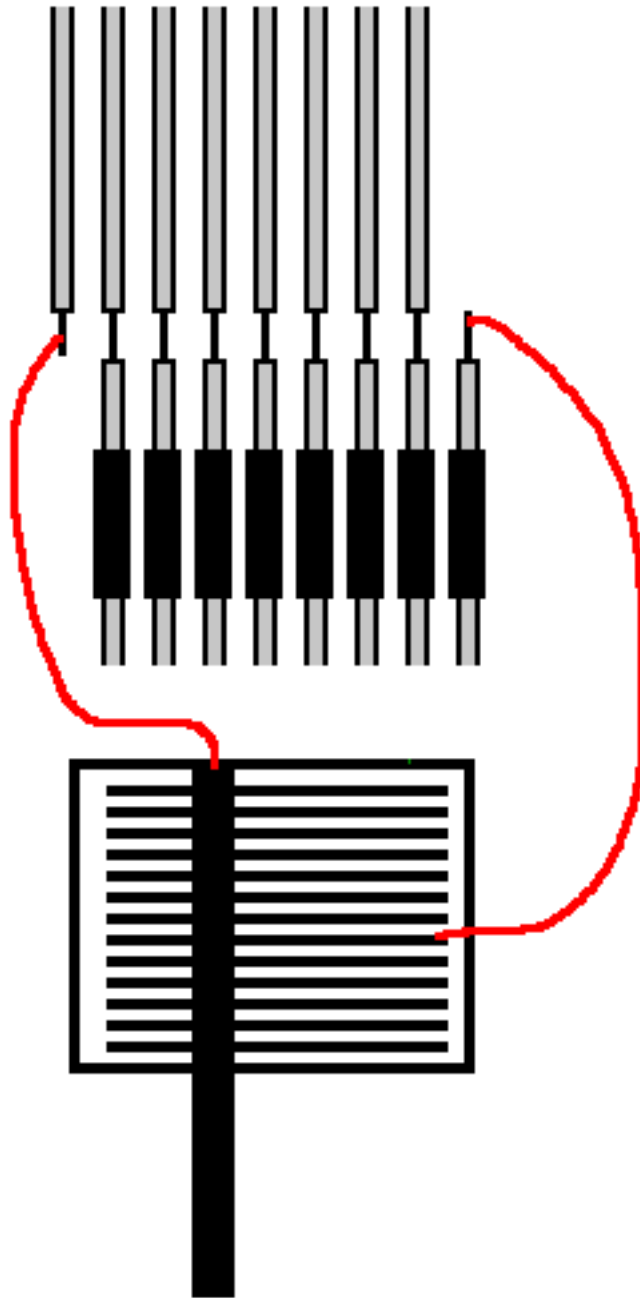

- Slip the two cross braces together for form an "X". This is best done on the floor, as there will be no real strength to the structure yet.

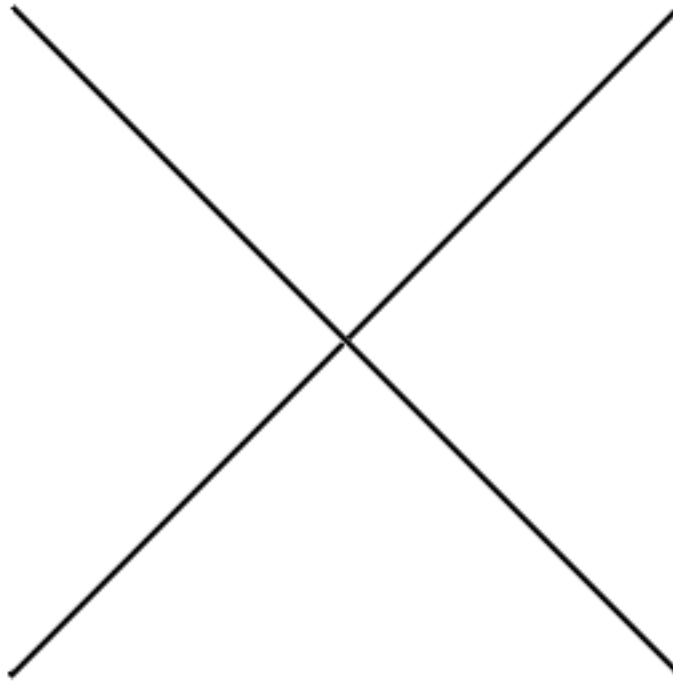

- Slip the ribbon cable over the four edges of the cross braces, slide to the middle. If it is too tight, the edges of the cross braces can be notched. If it is too loose, the ribbon cable will have to be shortened or small pieces added to the braces by stapling to the ends.

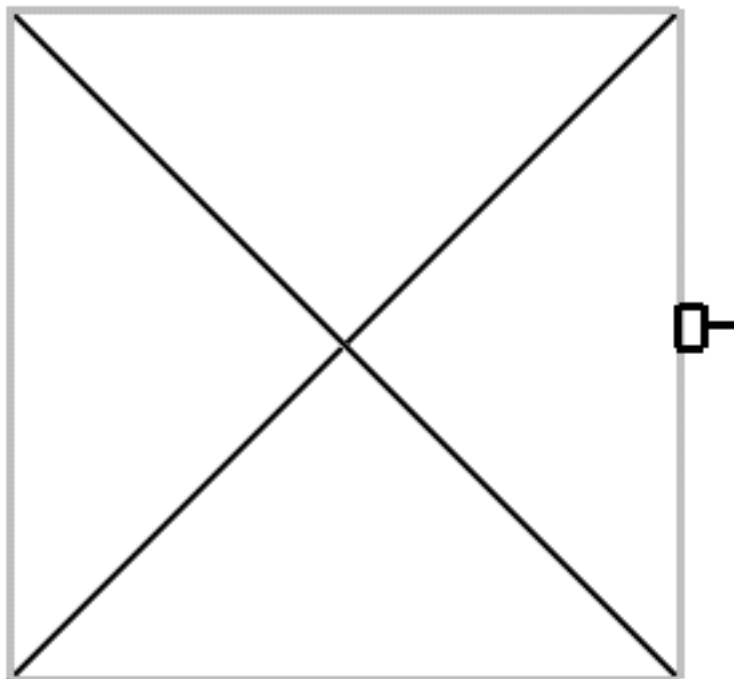

- At this point, the loop structure should be strong enough to erect vertically. It will probably not self support, however, and will need something to lean against (a wooden chair).

- Place a radio in close proximity to the loop, and tune to a weak station near the bottom of the band. Tune the plates of the tuning capacitor until almost closed, and try to optimize the weak station by tuning the loop. IF the plates are not fully engaged for a station at 540 kHz, there are too many turns on the loop. Re-solder the tuning capacitor to the next conductor in from the end of the ribbon cable.
- When the tuning capacitor is fully engaged at the low end of the band, double check the tuning at the high end with a weak station. The loop should tune the high end of the band with the tuning capacitor plates fully disengaged. I was able to compromise between the two ends of the band with 6 conductors in the ribbon cable and a low frequency limit of 550 kHz and a high frequency limit of 1650 kHz. If I wanted full coverage, I would have needed to add a switch to switch a conductor in and out.
- Slide the heat shrink tubing up and fully shrink it to cover the exposed conductors. Tape the tuning capacitor to the ribbon cable, unless you want to use a small plastic box or something to make it look better.
- A single turn "sense" winding can be made out of an extra conductor in the ribbon cable.

Some notes about the author's loop:

- Q of the loop is EXCELLENT - even at the high end of the band. This dispels the myth that winding spacing has something to do with Q - too narrow and the Q goes down.
- The [UMR EMC lab calculator](#) told me that I would need 8 conductors, which is also about the number of conductors in the 1 meter loop projects. This loop only needed 6 conductors, which was disappointing to me, because I thought they had the formula "right". I was able to measure the inductance of my 6 turn loop, and it comes out 200 mH. I have no explanation, unless the aggregate of RF energy in the Dallas area affected my inductance meter (I can usually see it fluctuate some, especially at night, when measuring one of these loops). I also suspect that inter-winding capacitance was making up the difference in capacitance and making it resonate in the AM band. Whatever the reasons, it tunes, it works, re-soldering (or taking off turns) is NOT the pain in the posterior I thought it would be. Hey - once you got a loop that works, you just don't care any more if the calculations were wrong. Just start out with too many turns or conductors, so you can take them off. Taking them off is a whole lot easier than adding them!!!
- A three foot loop is about the largest loop that can be constructed with this technique. This project started as a five foot loop, but the loop would not self-support, and needed to be "downsized".
- Test results in the metroplex were about what was expected. A GE Superadio 3 has little improvement, but "cheapies" show tremendous improvement. The antenna was taken to the remote test site described in the [four foot loop antenna article](#). The results are shown below:

**Internal Antenna Only**



<b>Frequency</b>	<b>Call</b>	<b>12-732</b>	<b>7-2887A</b>
540	KDFT	0	0
610	KSVA	0	2
620	KMKI	3	5
640	WWLS	3	4
650	WSM	0	0
660	KSKY	3	4
770	KAAM	0	0
810	WHB	0	0
820	WBAP	3	5
830	WCCO	0	0
920	KENT	0	0
1020	KCKN	0	0
1110	KYKK	0	0
1150	KUHD	0	0

<b>3 Foot Loop</b>			
<b>Frequency</b>	<b>Call</b>	<b>12-732</b>	<b>7-2887A</b>
540	KDFT	4	5
610	KSVA	2	2
620	KMKI	5	6
640	WWLS	5	6
650	WSM	2	2
660	KSKY	3	4

770	KAAM	5	6
810	WHB	2	2
820	WBAP	5	6
830	WCCO	3	3
920	KENT	5	6
1020	KCKN	5	6
1110	KYKK	6	6
1150	KUHD	2	2

# The Umbrella Loop



The 5 foot umbrella loop in its open "deployed" configuration.



The umbrealla loop folded for transport.

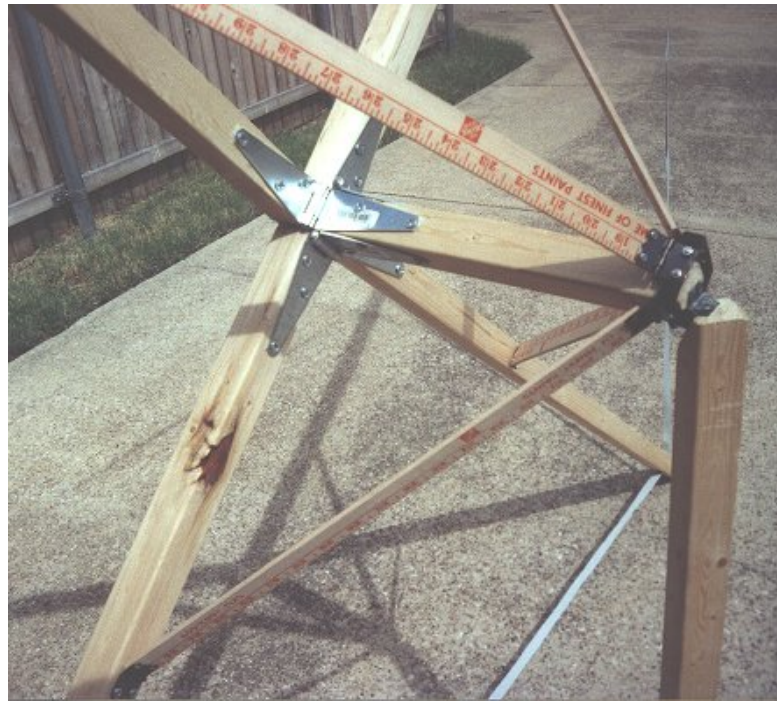

Detail of the folding mechanism of the umbrella loop.

## Introduction

Those of you who have read my previous articles know how I have "learned by doing". I started over 30 years ago salvaging loops out of old radios. About 20 years ago I used a simple formula based on the area and number of turns, and produced a 5 foot planar loop that was good for transatlantic listening - but included no tuning capacitor (it was internal to the radio). I then shelved the project for 20 years.

I still had my 5 foot planar loop, which was soon adapted to a [4 foot edge wound model](#) with a tuning capacitor. Unfortunately, the wood is actually getting rotted, so it sits in my father's storage shed 300 miles away. It has such a low Q on the high end of the band that I considered the performance unsatisfactory.

If you don't mind, I will digress a bit before starting this construction article. I have learned a lot of things in the process of building loops. Among other things, I learned that:

- The calculations for loops are not well documented. I still don't have a satisfactory algorithm. The calculators on the [front page](#) of this article series get you really close, but neither one is correct on the high end of the band. I did make a [2 foot edge wound model](#) based on the [Joe Carr formula](#) that was tuned properly from the moment it was constructed. But - for closely spaced loops, only the [UMR EMC lab](#) calculator gets close to the right number of turns. Furthermore, neither they nor the tesla calculation worked for the Terk AM advantage or its Radio Shack clone - both of which are circular loops. The number of turns is incorrect. A correspondent on an electronics newsgroup referred me to his executable program, which works for small loops but not large. His algorithm is not documented so I don't know where he got his calculations. His program also works for the closely spaced [3 foot ribbon loop](#) that I made, and for the loop described here. So I suspect that it is correct for closely spaced windings. Of course it does not work for widely spaced windings. The bottom line here for hobbyists is that it will probably be unavoidable to put too many turns on the windings and remove them until the loop can be tuned.
- Tuning capacitors are getting hard to find. If you want to build a loop - it would be a good idea to start scouring garage sales for old analog tuned radios. But - I have found that there are several types of tuning capacitors:

1. Extremely old radios and equipment have a type of tuning capacitor with a shaft down the middle, and the plates are on bearings and will not stay in position when the shaft

is released. What is more, the function of the plates is to act as series capacitors between two sets of stationary plates. While it might be possible to use these old devices as tuned elements for a loop, I consider them unsuitable. I was very excited to find some of these large, multi-section tuning capacitors at my local electronics junk shop. Imagine my disappointment when I discovered their true nature!

2. The 9.6 to 365 pF variety. These seem to have gone out of vogue about 30 years ago, replaced by:
  3. The 500 pF (maximum) variety. These are very nice for loop construction projects, because you have a real chance at getting a loop to tune the whole band with one capacitor. You can easily spot these, they have more plates than the 365 pF variety. Grab them when you find them!!!
  4. The 250 pF variety. These are smaller, and have less plates. This is also the type used in the little PCB mount types in portables. The second, smaller set of plates usually does not have enough capacitance to add up to 365 pF when put in parallel. I picked up three of these at my local electronics shop. Surprisingly - they can be used to make loops that tune the whole AM band! I will document these loops, constructed on large pieces of styrofoam, in future articles.
  5. Varactor diodes - I include these because this is where the industry is going. I consider them useless, because one of the nice aspects of loops is that they do not require power to operate. In theory, it would be pretty simple to use a varactor - just vary the voltage across it to get the desired capacitance.
- Multi-stranded wire seems to give better Q than solid wire. My 500 foot spool of doorbell wire is getting pretty depleted after 4 loop projects, but my latest projects use ribbon cable.
  - I am more and more convinced that getting complete coverage of the AM band is one of the hardest tasks facing the loop builder. I have come close with the two foot loop - it tunes from 550 to 1640 kHz. But the umbrella loop described here only tunes 640 to 1700 kHz. I had to include a switch on the windings to cover the whole band. This may not be that bad of a thing - you can expand the concept to cover shortwave bands.

If you have read my other articles, you know I am driven to make a practical - and portable - loop. I have a scenario of the "swimming pool", where I want music from a distant station with a minimum of hassle. The loop is impractical if it is large, heavy, delicate, or takes over 30 seconds to deploy. It is also impractical if it is hard to transport or store in its collapsed form. I wanted to make a really large loop practical to take and use almost anywhere. The [folding loop](#) was impractical because it folded to a flat shape that was too long to fit in a car trunk. The three foot [ribbon loop](#) was impractical because it was too delicate and took too long to deploy.

## The Umbrella Loop Concept

I saw the answer in an everyday object that just about everybody owns - an umbrella. Like my "ideal" loop, it needs to have a large deployed shape, yet needs to be lightweight enough to carry, and needs to fold to a compact form that is easy to store. It needs to deploy quickly. It has many characteristics in common with what I want for loop! But - could I make a loop antenna based on the umbrella design? I cannot use umbrella hardware directly, because it is metal. But - I found a way to use wood instead of metal for the supports, and a minimum of metal used near the center of the mechanism.

Like the 3 foot ribbon cable loop, this design makes use of ribbon cable. This is almost a necessity, because separate turns would get tangled with this design.

## Materials

1. Three 8 foot lengths of 2 by 2 lumber. This is usually the smallest size available at the lumber yard. Some warpage is almost inevitable, but does not affect the construction of the loop. Water sealed lumber will make your loop heavier. I suggest painting the finished pieces as an alternative to water sealed lumber.
2. 2 wooden yardsticks. I found these in the checkout lane of Home Depot for 69 cents.
3. 4 gate hinges with screws. Often times, gate hinges are not provided with wood screws (see next item).
4. 24 1 inch by 1/4 flat head wood screws.
5. 9 1 inch furniture hinges.
6. 12 4\*40 screws, nuts and washers.
7. 12 sheetrock screws.
8. one 2 inch by 2 inch by 1 inch slide assembly (see text).
9. 20 feet of 25 conductor ribbon cable. 25 conductor is the way it is commonly sold.

10. a 9.6 to 365 pF tuning capacitor.
11. a SPDT switch.
12. hookup wire.
13. eight plastic push pins (used during construction).

## Construction

This is a complex construction project (but not too bad). You need to be careful to do each step carefully. There will be some degree of customization and judgement involved - I will try to explain the rationale when you need to do this. I will also break this up into sub-assemblies to make it easier to follow.

### Constructing the Slide Assembly

The slide assembly is one of the most demanding aspects of this design. I spent many hours thinking about how to design this part of the umbrella loop. If you unfold an umbrella, the slide assembly is the thing that slides along the center support of the umbrella. I discovered that it needs to be quite strong - as it takes a lot of abuse. This made the selection of material critical. I searched for something commonly available, strong enough, and a material that can be worked equally. I finally settled on crate strapping metal. There are at least three types in use. One type is not metal at all, but plastic of some sort. Plastic is completely unsuitable - it is not strong enough. There is also a very flimsy metal type of strapping metal, as opposed to a thicker metal strapping. It is the thicker metal strapping that you are looking for. It is about 10 mils thick. It should be easy to beg some from somewhere - as it is usually discarded anyway - and people are anxious to get rid of it because it can cause injuries. I got mine from a computer room retrofit, where it was used to support 6 foot tall racks of equipment. I suspect that refrigerator and washing machines are also shipped with the same type of strapping metal, so stores that sell them may be a good source.

- You will need about 17 inches of thick crate strapping metal, and a scrap piece of 2 by 2 lumber to use as the bending form. 2 by 2 lumber is NOT two inches by two inches - it is smaller. But you will be using it to make a 2 inch by 2 inch metal framework - that will slide easily over a piece of 2 by 2 lumber. A tight fit is NOT necessary.
- Measure 2 inches of strap metal. Bend across the edge of the scrap piece of 2 by 2. It is NOT NECESSARY to make a really tight bend. In fact, the metal is a bit brittle and may break if you bend too sharply. It is best to leave a little radius in the metal at the bend.

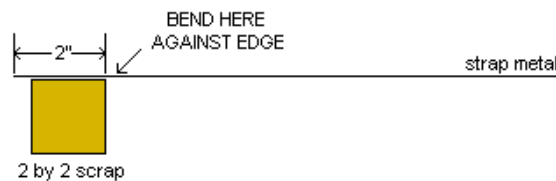

- Make three more bends at two inch intervals until the strap metal makes a square frame.

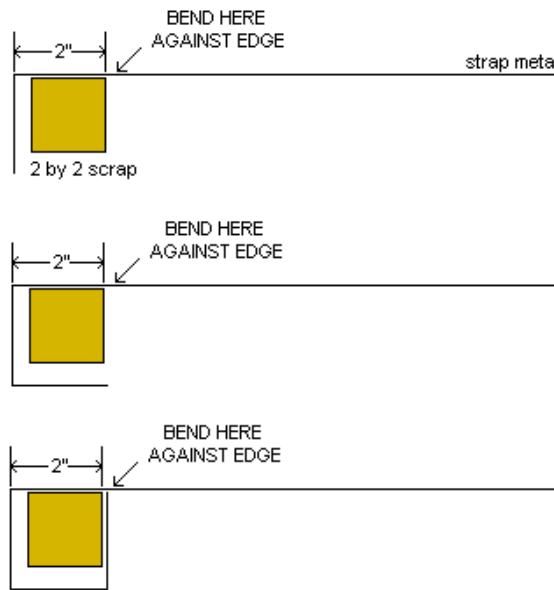

- Make a second layer of strap metal around the first by making four more bends. These bends will be slightly larger than 2 inches, so do not measure. Just bend over the inner bend of metal. The graphic shows some space, but wrap tightly. Break off any excess strap metal.

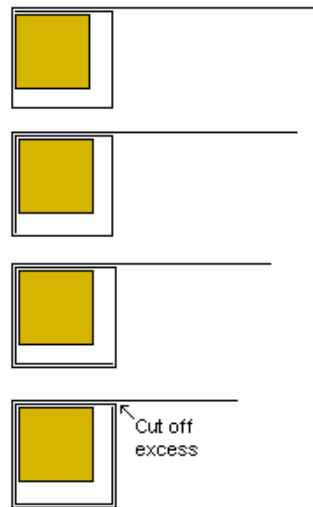

**WARNING** Hold the strap metal tightly or secure in a vice for the next step. Don't let it get away from you, it can cut you! If you slice your finger, don't come crying to me about it with some slimeball lawyer. I warned you!

- Drill two holes in each side of the metal frame to match those in the furniture hinges. Go through both layers of strap metal. It really helps to drill into that scrap piece of 2 by 2, but any way you do it - it is difficult to hold safely. But - I am a total klutz and I did it, you can too!

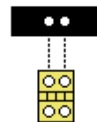

- Attached hinges to the metal frame with number 4 hardware. Do yourself a favor and start with the side that wants to unfold. I am not a mechanical engineer and do not have the exact terminology and length for the bolts - just a bin full of number 4 stuff. Nevertheless - make the bolts the rounded head type, because they will need to slide smoothly up and

down a support without tearing up the wood. You can also use lockwashers if you wish.

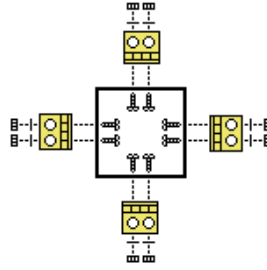

You now should have a nice little square metal frame with hinges on it. Next, we will take this assembly and add the "spokes" to it - similar to the spokes that attach to the sliding part of an umbrella. Only we are going to use yardsticks.

## Constructing the Spoke Assembly

- Prepare the spokes by cutting the two yardsticks in the middle. They are already marked at 18 inches for you! Yes - I know it is a shame to ruin them, but if you read through these directions in advance - pick up a couple of extra to alleviate your guilt. Then you will have them handy for other measurements in this project.
- Drill holes to match the furniture hinges at each end of the 4 pieces of yardstick. THE DISTANCE BETWEEN THE HOLES SETS AT EACH END IS CRITICAL!!! You can measure precisely and drill one piece at a time if you like, but it is a lot easier to tape all four together and drill through all four at a time. The yardsticks are not very thick, so this is not hard to do.



- Attach the four spokes to the top of the four hinges on the slide assembly using number 4 hardware. Attaching to the top of the hinge is necessary, because the spokes will need to fold flat against the center support. The screw needs to come from underneath.



- Attach hinges to the top of the far ends of the spokes with number 4 hardware. The screw needs to come from above. The spoke needs to be underneath and the screw head needs to be on top because the spoke will need to fold flat against the frame. The spoke will actually fold through about 135 angle at the frame, so this is fairly critical.



- You can now fold up the spoke assembly until it is needed for final mechanical assembly. Next, we will make the frame.

## Constructing the Frame

- Cut all three of the 8 foot 2 by 2 pieces of lumber in half, to obtain 48 inch sections. You will use 5 of the sections with one in reserve in case of mistakes.
- Cut one of the remaining 48 inch pieces into two pieces, one 34 inches long and the other 14 inches long.
- This is a difficult step, it involves making an angle cut on the end of the 14 inch piece of 2 by 2. You may want to use a mitre box. Start by marking the cut on the end. Draw a 45 degree line from the middle of one side to the middle of an adjacent side. Next, mark the side of the piece with a triangle extending down about two inches along the sides, starting at the line you drew on the end. Next, using a coping or other saw designed for fine work, saw off a triangular wedge of the side and end of the piece. The wood to be



removed is marked with an "X" on the picture. If you do not have a mitre box, starting on the edge instead of the end may prove easier.

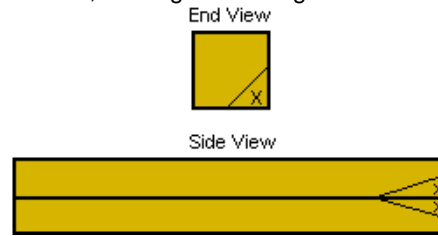

- Make the same cut as the previous step in the 34 inch piece of 2 by 2.
- Attach a gate hinge to one end of the 48 inch sections. Position it such that when unfolded at a 90 degree angle, the flat part of the free end of the hinge is flush with the end of the wood. You should pre-drill holes for the screws, as they are large and may split the wood if you try to screw them in without pre-drilling.

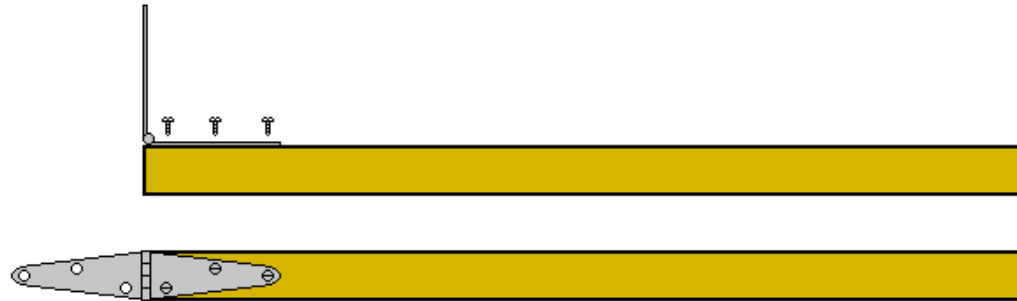

- Attach one side of a gate hinge to the upturned face of each of the 4 pieces, such that when the hinge is opened 90 degrees, its flat side is flush with, and parallel with, the end of the 48 inch piece.
- Lay out four of the 48 inch sections into a cross shape, with 4 ends close together. Take the 14 inch piece of 2 by 2 and position it vertically in the middle of the 4 pieces with the hinges attached. Place it with the diagonal cut up. Fold over the open end of the hinges until you are ready to attach.



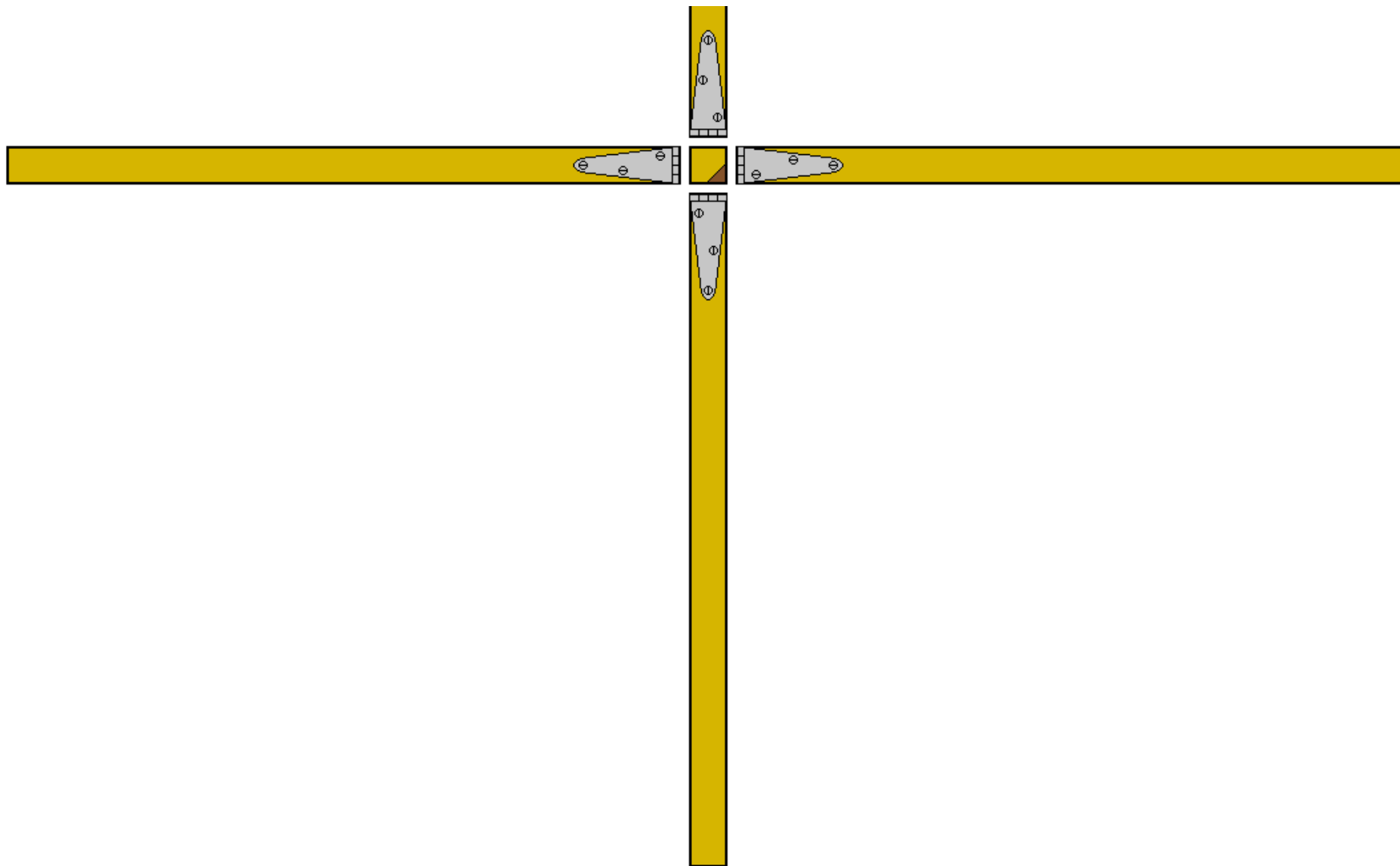

- Attach the open side of the hinges to each side of the vertical piece. The bottom of the 14 inch piece should extend to the floor, and flush with the bottom of the 4 48 inch pieces of 2 by 2. Again - pre-drilling the holes for gate hinge screws is mandatory. Also - the physical arrangement of screws should prevent interference on all but the top screw. It is a good idea to pre-drill the top holes slightly diagonal so the screws will clear each other.

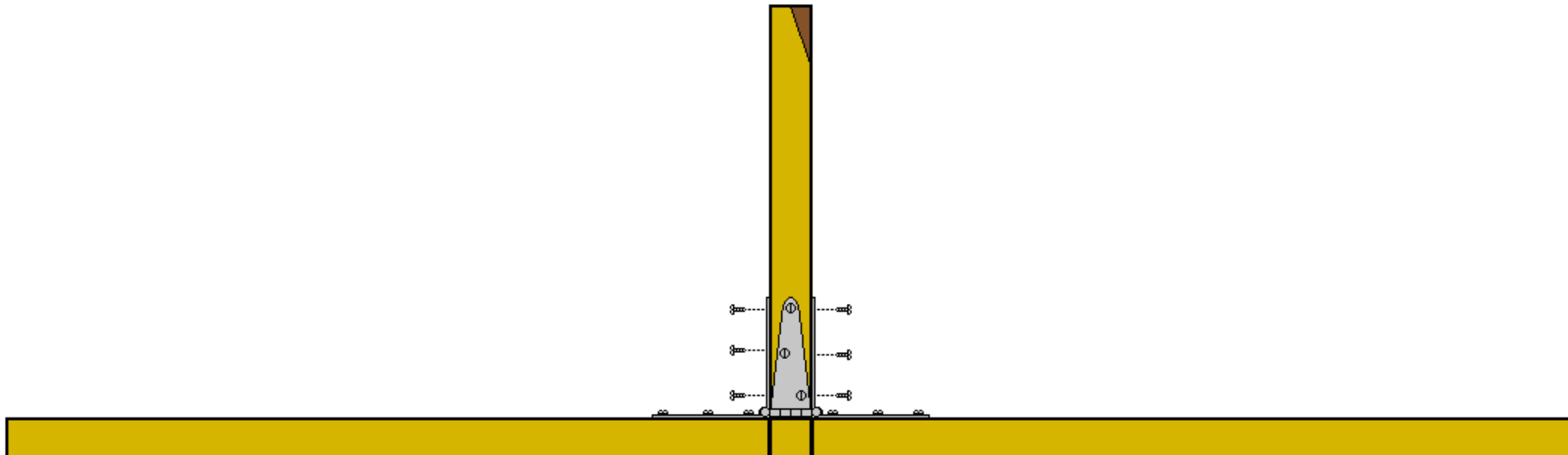

- Leave the frame assembly on the work area for the next section of the assembly process.

## Mating the Slide Assembly and Frame Assembly

This step involves completing the basic "umbrella" mechanism. It will involve a bit of trial and error to get it right, so you are encouraged to play with the mechanism as much as you can to verify that it will work. Now is the time to fix any problems - not when the fragile loop winding is on the frame and can be damaged.

- Unfold the slide assembly, and slide the 2 inch metal frame over the center support of the frame assembly as shown below:



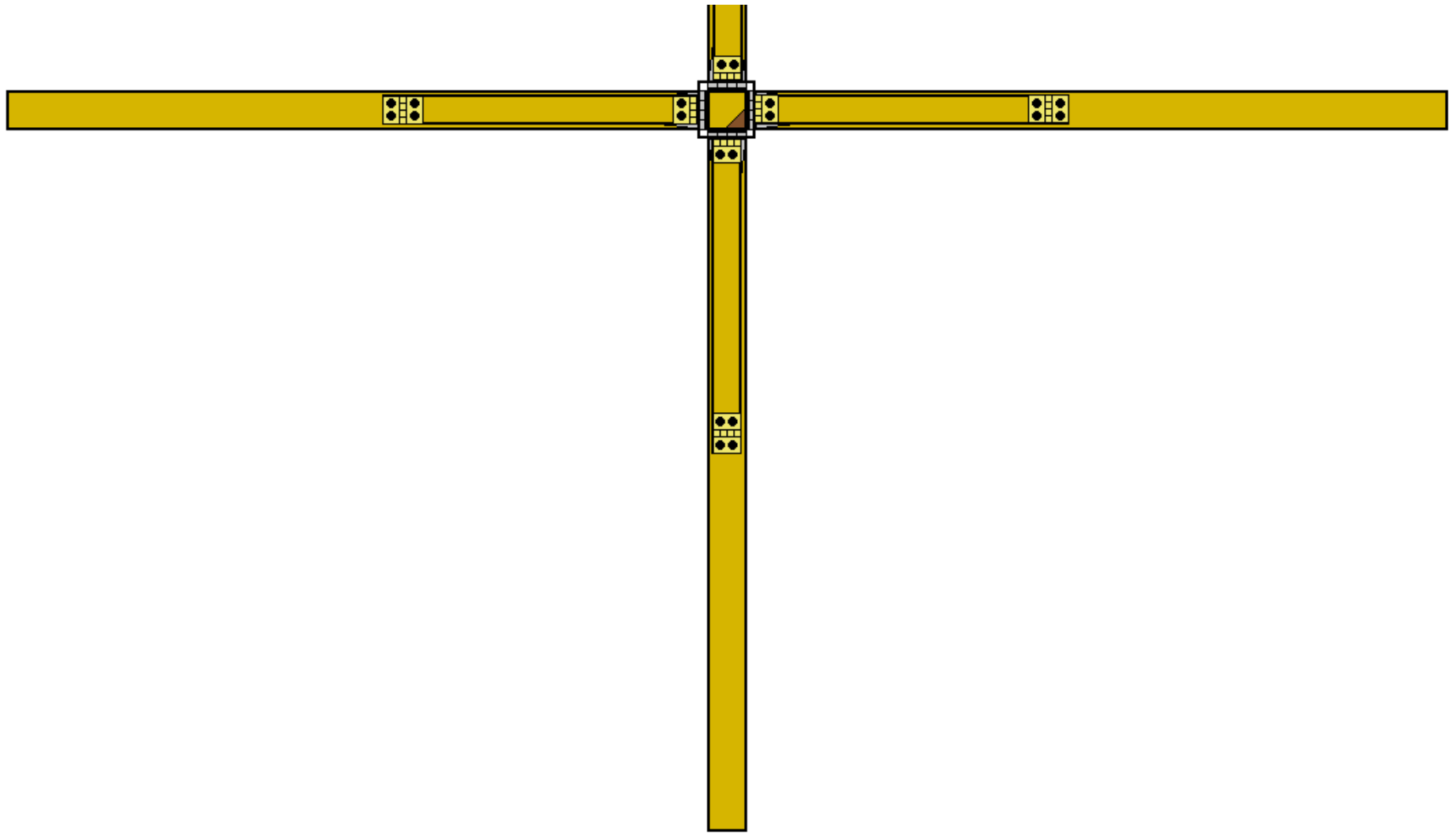

- Starting with the small screws supplied with the furniture hinge, attach the spoke hinges to the frame. The picture is not quite to scale, but gives the idea. Make sure that the top of the slide assembly is flush with the top of the vertical support of the frame. Make sure there is about the same amount of slack between the slide and the vertical support on all four sides. The spokes will angle down to the frame, and ideally intersect the frame at the same place on each support. This is not a given, however. I had to fold and unfold several times to "get it right". That is why you want to start with small screws that don't make a big hole. The folded position is much harder to get right than the open position. It is better to have some misalignment open than it is folded - as you might not be able to fold it all the way and you might put stress on the mechanical members when folding. Trial and error is the order here. Also - beware for your fingers, you can pinch them pretty easily between the vertical support and the slide assembly!

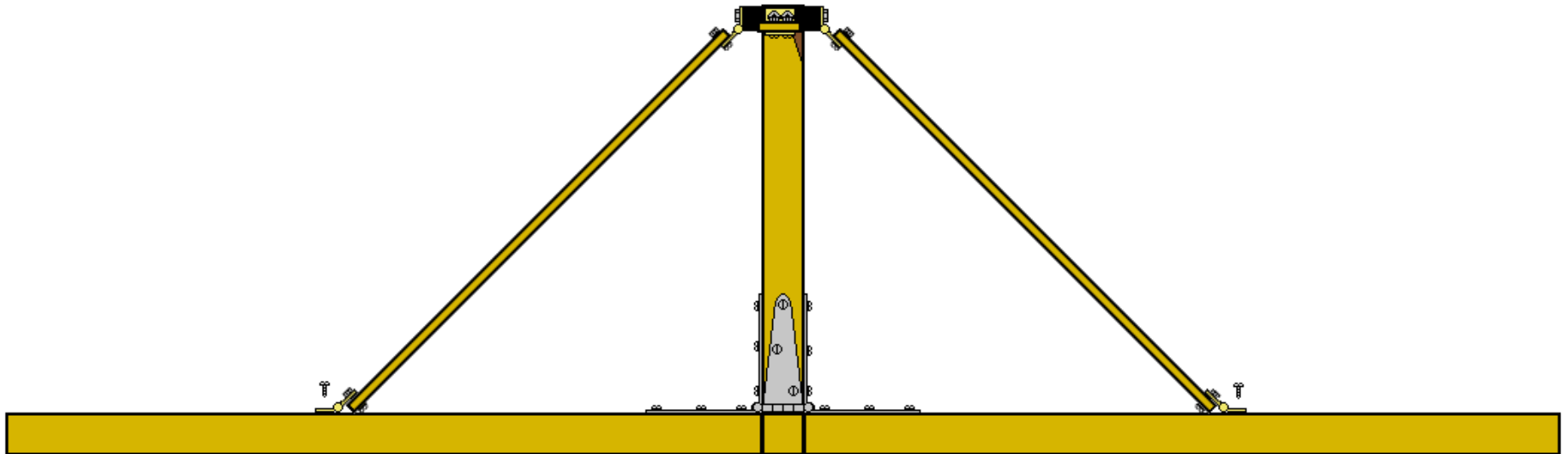

- When you do "get it right", replace the hinge screws with sheetrock screws. Sheetrock screws are skinny, so they will fit through the holes, their heads are flat, and they are tremendously strong to take the stress. It is best to pre-drill the holes for the sheetrock screws. If they are too long and extend out the other side of the frame, cut them off with a hacksaw and sand down the stumps.

A note on "notching" - it is OK to notch the frame slightly to accommodate spokes and their screw heads, although I did not find it necessary. The spokes and screw heads just barely touched the frame in the open position when I built my loop.

## Constructing the Loop

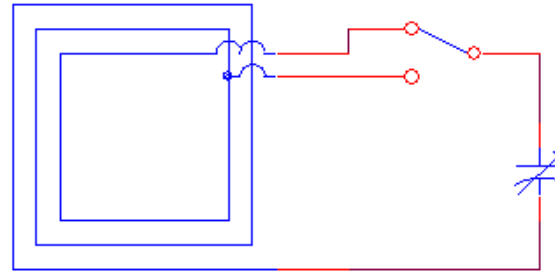

This series of steps involves making the actual loop. The simplified schematic is shown above - the actual loop has 6 turns, but that would be difficult to show so I simplified it. The schematic reflects the fact that I needed to switch one turn in and out to cover the whole AM band. I found a mice little plastic box in which to house my circuit - I suggest you do the same. Even something like those fake "chewing gum pagers" have nice plastic boxes in which you can mount the switch and a small tuning capacitor. Attach to one of the supports with a couple of small wood screws.

- **Important!** Make sure the ribbon cable is flat - no twists.
- Prepare the 20 foot length of ribbon cable by separating the wires about 1/2 inch on each end. Strip and time every other wire (odd numbered wires). The even numbered wires are used to reduce wire-to-wire capacitance of the loop. Extra turns can be left in the ribbon - they will help give it strength.
- Slip a small piece of heatshrink tubing on the wires that were stripped and tinned on one end.

## AM Loop Antennas - the Umbrella Loop

- Starting with the first wire on one end (usually marked with a color stripe), solder it to wire number 3 on the other end (is the cable still flat?). If the start of the loop is "0" in the picture, then the connection of wire 1 and 3 is the first turn - "1".
- Continue by soldering wire 3 on one side to wire 5 on the other side, wire 5 to wire 7, etc as shown in the picture below to form 6 turns of the loop.
- For all but turns 0, 5, and 6; slide the heatshrink tubing over the connection and shrink it.

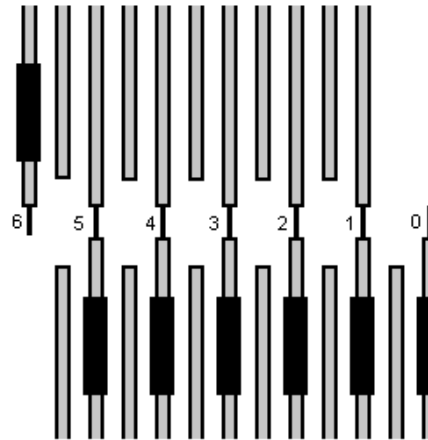

- Using a short piece of hookup wire, connect turn zero of the loop to the frame (and moving plate) connection of the tuning capacitor.
- Using short pieces of hookup wire, connect turns 5 and 6 of the loop to outer two terminals of the switch.
- Using a short piece of Hookup wire, connect the center terminal of the switch to the variable terminal (fixed plate) connection of the tuning capacitor.

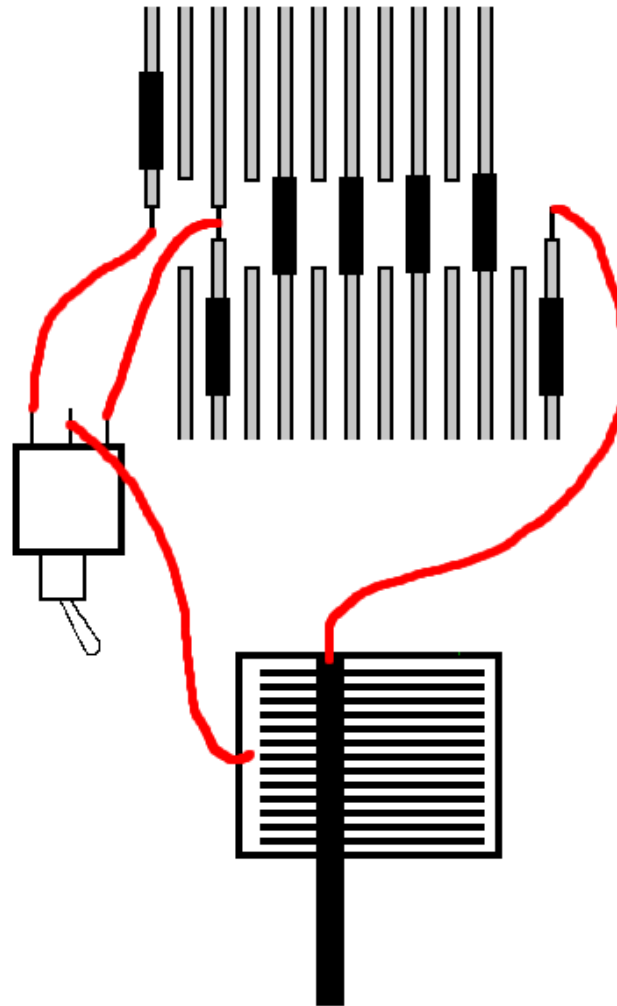

- Slide the heatshrink over the three connections on the loop and shrink.
- Mount the switch and tuning capacitor in a box using whatever technique you have decided on.

## Hanging the Loop on the Frame

This section also involves a bit of "trial and error". It is important that the open (deployed) frame not stretch or otherwise put stress on the delicate loop. Tolerances during assembly make it impossible for me to give you a really good measurement here, but you can get close. If you make a mistake and are an inch off on one support of the frame, the loop will not be a perfect square - but that will not affect it to any degree. Also - the loop must remain a little bit slack. This will mean that the loop will not produce as good a null as some other loop designs, but the large size of this loop makes it optimum for reception of very distant stations - not nulling.

- Arrange the loop across the four supports of the frame. Use plastic push pins to support the loop on each support, start with one on each support, then two - one near each edge as you refine the measurement. You are trying to get the loop supported equidistant from the end of each support. It helps to pre-mark each support with about 3 inches of marks from each end. Your final measurement will be about an inch and a half from each end.



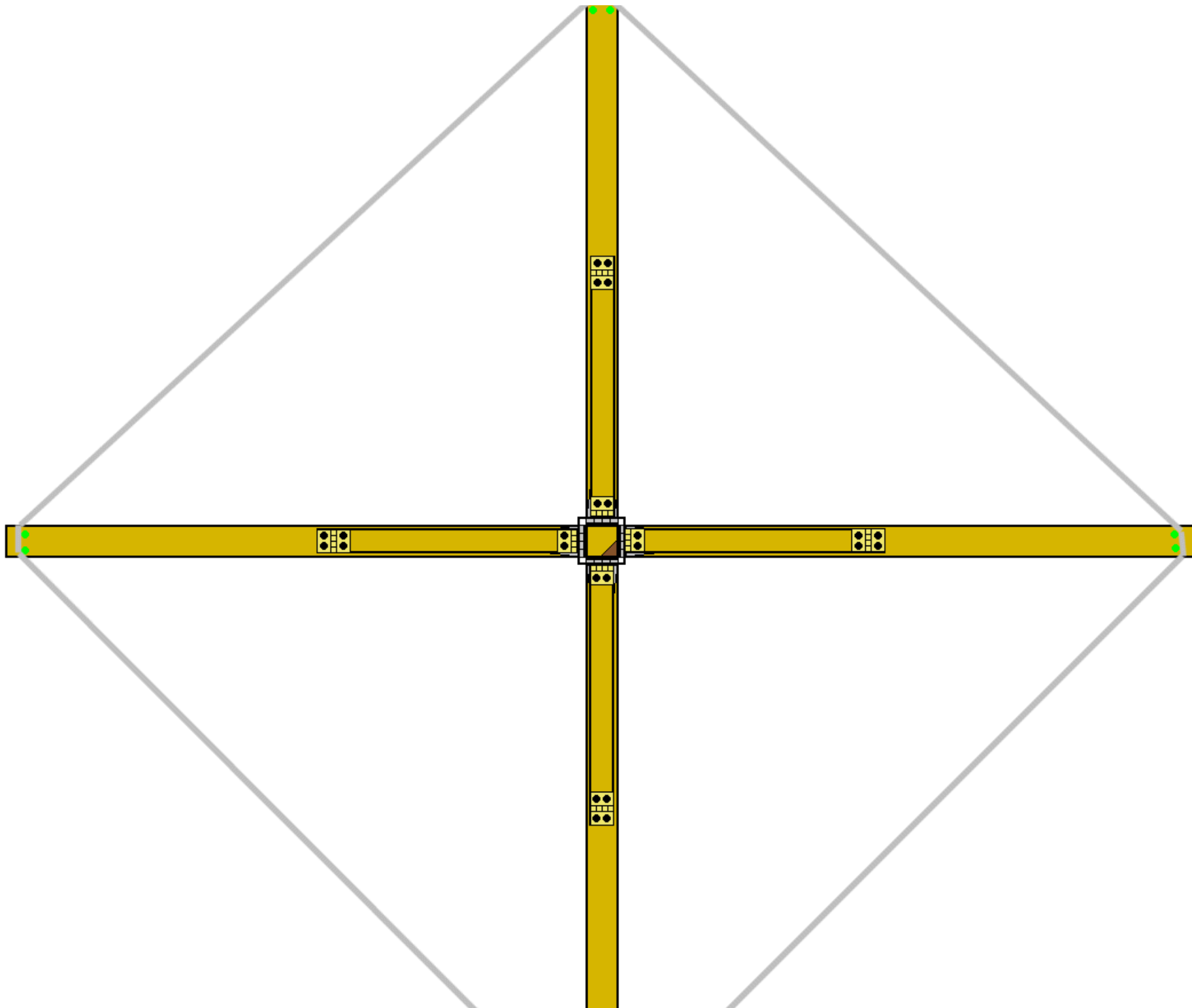



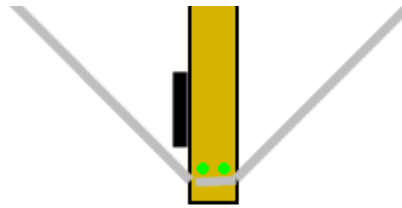

- Mark the position on the end of each support where the loop crosses, and saw down about half way through the support. Your goal is to be able to easily slide the loop into the cut. The wire should be easy to slide into and out of the cut (it should not be so tight that there is no movement).

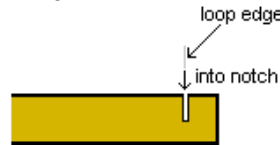

- Do this for all four supports. The last support should be done so that the loop is snug, but not stretched. Some stretching will inevitably happen, and another notch can be made later if necessary. I can almost guarantee that the last support mark will not exactly match where the notch ought to be - use trial and error again.
- When hanging the loop, keep in mind mounting of your tuning capacitor box.
- Mount the capacitor tuning box securely to one leg of the loop. You might want to keep in mind that the loop will be tossed in the back of a car, dropped on the ground, etc. Make sure that the shaft of the tuning capacitor is on the side of the leg, not an outward facing surface. I broke a tuning capacitor that way when I was constructing mine!
- Slip the loop out of the 4 support legs, and wrap it up near the tuning capacitor. This will protect it when the loop is stored, deployed, and taken down.
- I took some little pieces of popsicle sticks and fastened them snugly with a wood screw, but where they could still turn, right below the slots for the loop on each leg. This is not necessary, but could be used to keep the loop from slipping out when deployed.

## Attaching the Leg

This last step attaching the leg that will allow the loop to stand on its own, without leaning against anything. Be very careful not to damage the loop you just hung in the last section as you work!

- Pre-drill holes to support sheetrock screws in the vertical support of the frame, matching the spacing of a furniture hinge. The goal is to make the hinge pin edge line up with the diagonal cut.



- Attach the furniture hinge to the vertical support with sheetrock screws.
- Pre-drill holes to support sheetrock screws in the 34 inch piece of 2 by 2 the same way you did for the vertical support.
- Attach the other side of the vertical support to the 34 inch piece of 2 by 2 with sheetrock screws.

**This (finally) completes assembly (WHEW!)**

## Deploying the Antenna

If you still have the antenna face-down on the work area and haven't figured out what is going on just yet - lift it up and support it on its side by the leg. The figure below is a pretty close (though admittedly not perfect) representation of what is going on. The leg is the right length to allow the loop to rest slightly tilted against it - but in a wind it will blow over. The leg also serves to hold the slide assembly in place when deployed. When the leg is folded up, in line with the loop's center support, it allows the slide mechanism to slide freely, collapsing the loop. It is normal for the loop to be slightly out of "square", due to loose tolerances in the gate hinges. This won't hurt anything.

Once the frame is up, you can then take the loop and hang it on the four legs (you might have to slip it under the support leg). Slide it in the notches and if you put popsicle stick pieces to hold the loop in the slot slide them across the slot. The function of the loop is NOT to support the top two support legs at 45 degrees!!! Just let them stay where they are and hang the loop. The loop wire is not strong enough to pull them up so the loop looks like it is a perfect orthogonal structure.

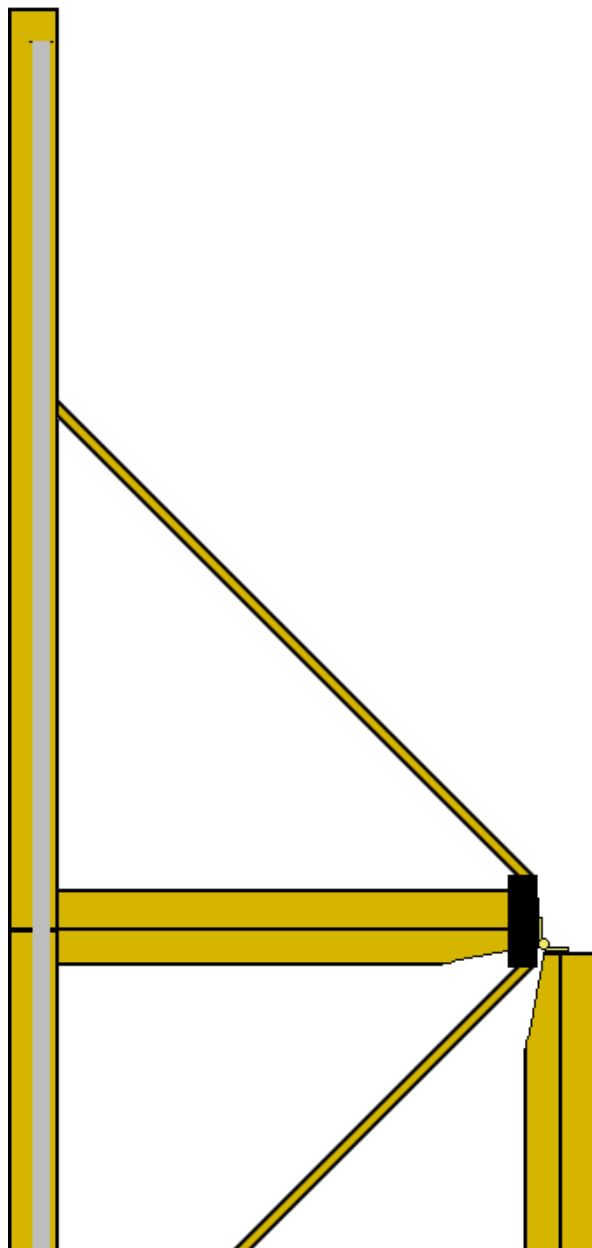

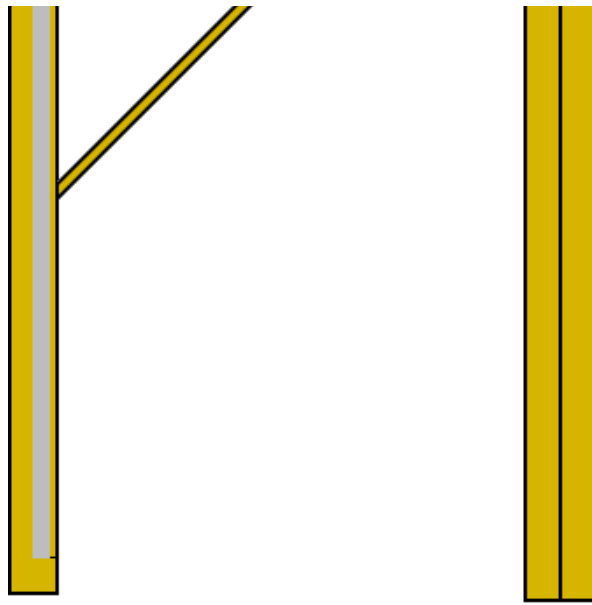

#### Deployment notes ----

- I find that a bungee cord is useful to hold the loop in its folded configuration.
- When taking the loop down, take the loop off of the support legs FIRST, then wrap it up BEFORE folding the frame. The loop is delicate. You can rip out the connections if you try folding and unfolding with the loop in place.
- My loop is constructed out of regular lumber. Pressure treated could be used, but would make the thing heavy.

Well, there you have it. The umbrella loop won't keep you dry, but it is an elegant way of having a large loop that stores and transports easily.

## Test Results

When I took the thing out to my remote test site at my father's house, there was a week of thunderstorms. As any AM DX'er will tell you - that is the END of your DX'ing! Nevertheless, I have found a good test station in the Dallas / Ft. Worth area. It is [KKYX 680 kHz](#), a 50 kW (daytime) station from San Antonio. The format is classic country - so it is nothing I would be interested in receiving - but it is a good test candidate. Even on a GE Superadio 3, the signal is barely listenable - a 2 by the "1 to 7" criteria I set up in the 4 foot loop antenna article. The transmitter is located at 29° 30' 3" N 98° 49' 54" W, making it about 274 miles from my listening location in the DFW area. Reception of this station improved to a 5 to almost 6 using both the GE Superadio 3 and the Optimus 12-603. As expected, the loop did not produce deep nulls, although reception of the 550 kHz station from San Antonio improved markedly when the loop was tuned to 550 - even with the presence of a strong 540 kHz signal in the area.

I found that the loop would tune from 640 kHz to 1700 kHz on one switch position, and about 540 khz to 1500 kHz in the other - full coverage of the band.

I have tested this loop at my remote test site. Results were similar to those obtained with the 4 foot loop on the lower part of the band, but vastly superior on the upper part of the band. I can sum it up in one word: HOT!!! Also very high Q - I spent a couple of hours DX'ing every 50 kW station within a thousand miles of Lubbock. Reception varied from barely readable on WSB Atlanta to loud and clear on KOA Denver. Daytime DX of this nature is characterized by very deep, very slow fades. A station barely readable one hour may be booming in an hour later - so reception tests are not included here due to this variability that I suspect weighted earlier test results. At some time in the future, I may assemble a ten foot loop out there and attempt to characterize distant (more than 1000 mile) daytime DX. I suspect that stations much further may also be receivable, if you can catch them between deep fades. One of the

[http://www.mindspring.com/~loop\\_antenna/umbrellaloop.htm](http://www.mindspring.com/~loop_antenna/umbrellaloop.htm) (17 of 18) [9/6/2004 8:21:28 PM]

surprises of the day was reception of an extended band station in the 1640 to 1660 region from due North of Lubbock. 45 minutes of listening yielded no station ID, but reception was between 6 and 7 by my original criteria. Without the loop, there was not a trace of the station. Perhaps I will try to figure out where it was coming from at some point in the future. But one thing this pointed out - sensitivity of the large loop was greater on the high end of the band. MUCH greater. From zero reception to loud and clear. If the sensitivity of a large loop is indeed proportional to its aperture (as we all have basically known), then the aperture of the loop is much greater to stations on the high end of the band. This has profound implications for shortwave listeners - and to those of us who want the 50 kW monsters on the low end of the band. Or even the longwave DX'ers: It is much more important to get a large aperture on the low end of the band than the high. And even a very small loop may be a good performer for shortwave.

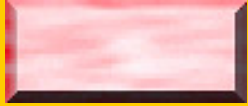
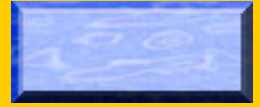
**MDS975****LOOP  
AERIALS  
And  
ATUs****MDS975**[Back to Home Page](#)[To - ATU's - ANTENNA TUNING  
UNITS](#)[Radio Stations & Memorabilia](#)[To DXing And SHORTWAVE RADIO](#)[MAKE A SIGNAL METER](#)**LOOP & FRAME AERIALS  
and ANTENNA TUNING UNITS****LOOPS**

A Loop or Frame aerial is a wonderful tool to assist longwave and mediumwave reception and, indeed, is absolutely essential for serious long distance reception (DX-ing). Fortunately a loop aerial is extremely easy and cheap to construct, you may even have most of the parts required in your junk box. I offer a few pointers to the construction of loop aerials below.

**ATUs**

For good Short Wave reception long 'random wire' aerial really is required to dig those distant stations out of the ether. To effectively couple such an aerial to a radio a matching unit called an ATU (Antenna Tuning Unit) can be extremely helpful. An ATU is relatively straightforward to construct and uses simple parts that are quite easy to obtain. Go to the [ATUs page](#) for a few pointers.

**LOOP AERIALS**

A loop aerial is extremely helpful when trying to receive long distance stations, not only will it dramatically 'boost' the signal received compared to using a portable radio's internal ferrite rod aerial because a loop aerial is much bigger than a ferrite rod, but it also has two other very useful properties: **Directivity** and **Selectivity**. Directivity is very useful in that it can often be used to 'null out' an interfering station and selectivity is useful to overcome overloading of the radio's 'front end' as the loop will tune very sharply to the required frequency will rejecting all others.

A loop can be made for Medium Wave and Long Wave and can be of almost any size you wish, though it must be small enough to fit in your listening room. The bigger the area of the loop the more signal it will collect, the portable loop described below is around 40 cm in diameter and is probably the smallest size worth considering to be effective and useful.

## Portable MW Loop



The portable loop in use, the portable radio is simply placed into the centre of the loop and the signals collected are inductively coupled to the internal ferrite rod antenna of the radio

Traditionally loop aerials have been made on large frames about 1 meter square for use with communications receivers, however the loop shown to the left is much smaller at 40cm (17") and designed for use with a portable radio. The radio is simply placed in the middle of the loop and the signals collected are transferred to the radio via its internal ferrite rod aerial.

The circuit for a loop aerial could not be simpler, being a spiral loop consisting of 10 turns\* of 7/0.2mm 'hook-up' wire wound on the 40cm former, and a tuning capacitor to resonate the loop aerial at different frequencies.

(\*about 40 to 50 turns for Long Wave).

If it is required to connect the loop to a radio via its aerial input terminal then a second winding of just 1 turn of wire is wound over the main 10 turn winding. This secondary winding acts as a coupling coil that is connected to a suitable socket so that a cable can be run from the loop aerial to the radio receiver.

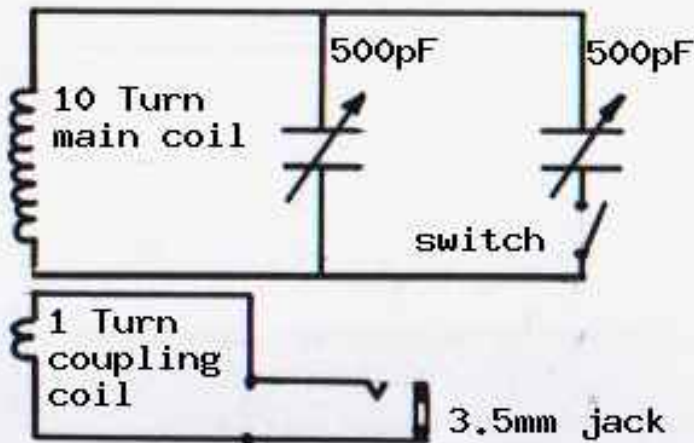

The circuit diagram of the loop showing the 10 turn main winding (100uH) and the tuning capacitor, together with a second capacitor that can be switched into circuit to provide tuning of the lower frequencies of the medium wave band. The second 1 turn

The circuit diagram on the left shows the main loop winding of ten turns (100uH) and the variable capacitor which tunes the loop aerial to the required frequency. Ideally the tuning capacitor should have a value of 700pF to cover the whole of the medium wave band. However standard 500pF tuning capacitors seem to be more widely available and will generally tune the medium wave band from around 700 kHz to 1600 kHz with a 10 turn winding.

To Tune the lower portion of the band a second capacitor can be switched into the circuit to provide the increased capacity required. The second capacitor can be in the form of a variable trimmer that can be pre-set

coupling winding allows direct connection to the aerial terminals of a receiver.

For Long Wave reception about 40 to 50 turns may be required.

to the required value, usually around 200pF. The second capacitor *could* be another tuning capacitor (as shown in the diagram), but that could be rather expensive. Alternatively a fixed capacitor could be used, the best value determined after a little experimentation.

The second coupling winding is of one turn and allows the aerial to be directly connected to any radio with antenna terminals or an aerial socket.

Scanned in below are my notes for the construction of the portable loop. The former of the loop was made out of 'Trent' plastic edge strip that was available from my local DIY store. This edging is about 20mm wide with a 6mm channel, though any similar edging or plastic product such as curtain track, perhaps, could be used. The strip is bent into a circle of 40 cm in diameter with the channel on the outside and fastened to a wooden block with some large head screws. The 10 turns of 7/0.2mm hook up wire are carefully wound side by side around the former and connected to the tuning capacitor. I used red strip and blue wire to be colourful.

The single turn coupling winding is wound next to the main winding and connected to the output socket. I simply used a 3.5mm jack socket as this is the same as on a Sony portable radio, though any coaxial socket could be used such as Belling Lee or PL259 etc.

The loop and wooden block are fixed into a suitable plastic box of about 150mm x 100mm x 60mm, the wooden block and heavy tuning capacitor adding weight to aid stability. A suitable box would be BOX034 from [Bowood Electronics](#).

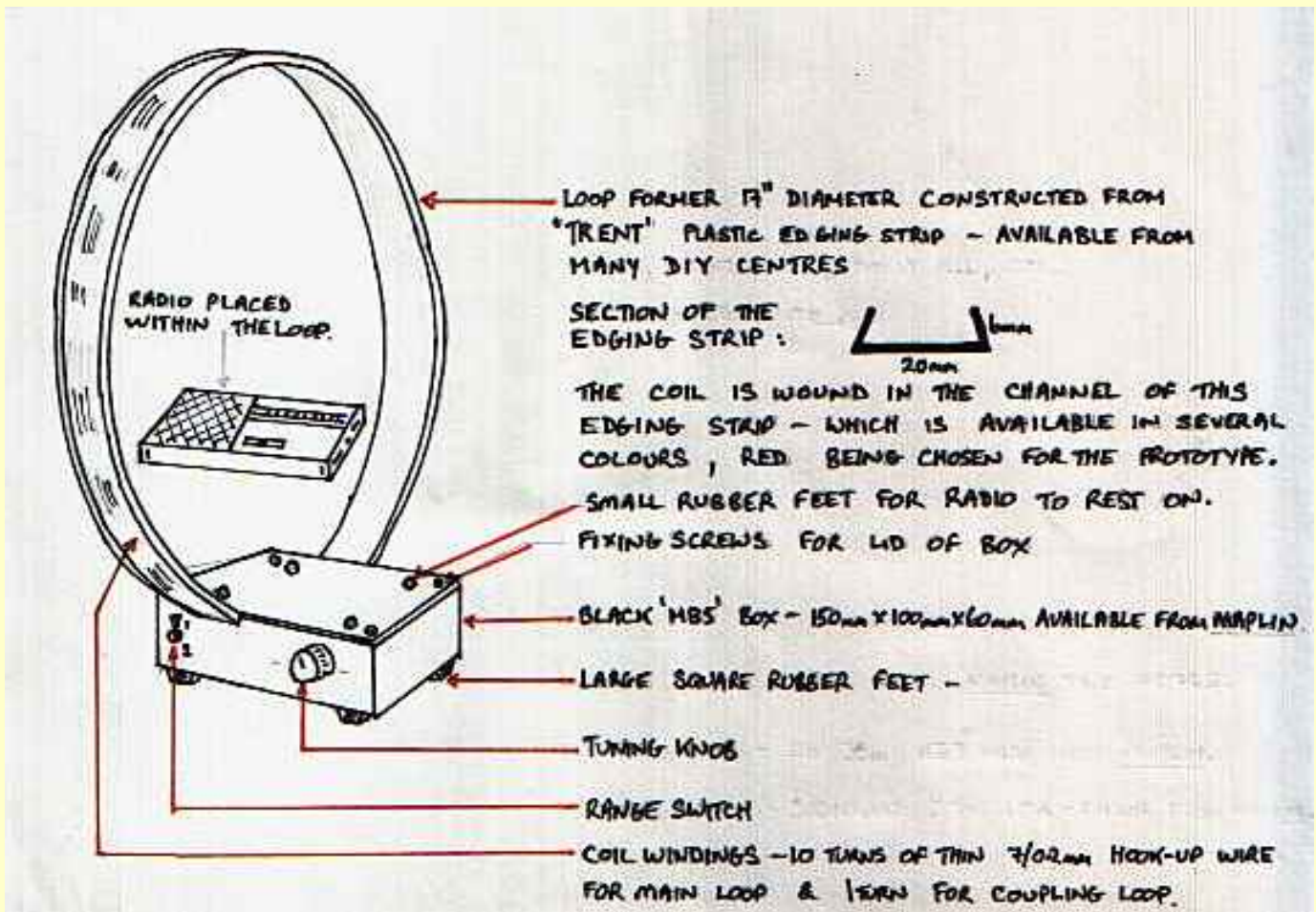

Drawing showing the external appearance of the Portable Loop Aerial

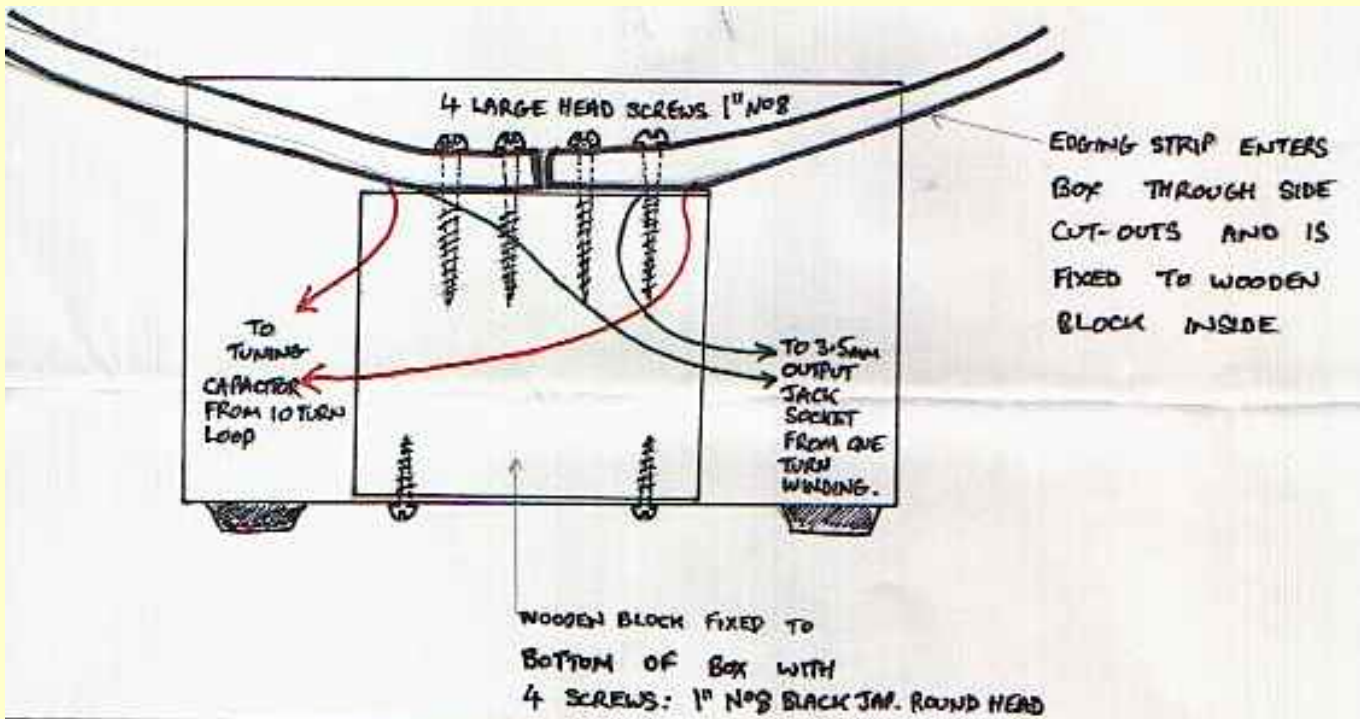

Drawing showing how the loop is fixed to a wooden block and secured into the enclosure



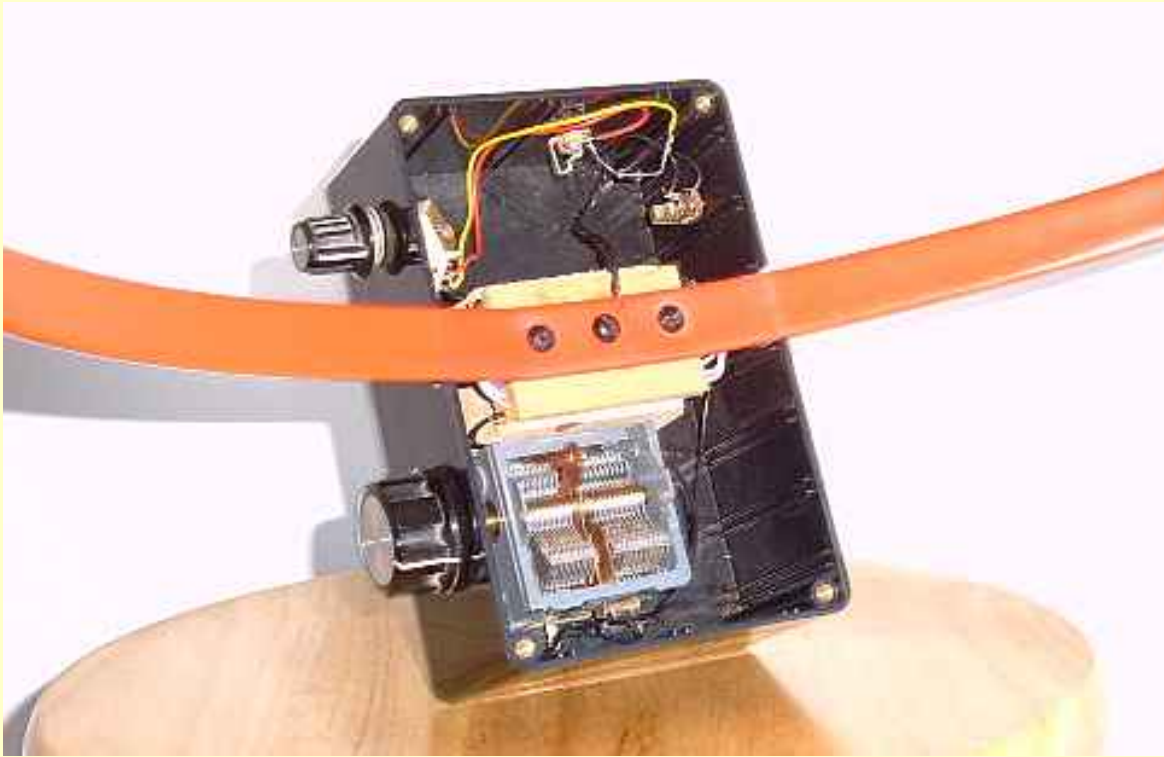

Internal photo of loop aerial showing air-spaced Tuning Capacitor (bottom left), Range Switch (top left), Output Socket (top), Wooden Block to which the loop former is attached (centre).

[Note the 3.5mm jack socket on the back panel (top right), this is for a crystal earphone as this loop is also a portable crystal set - see below]

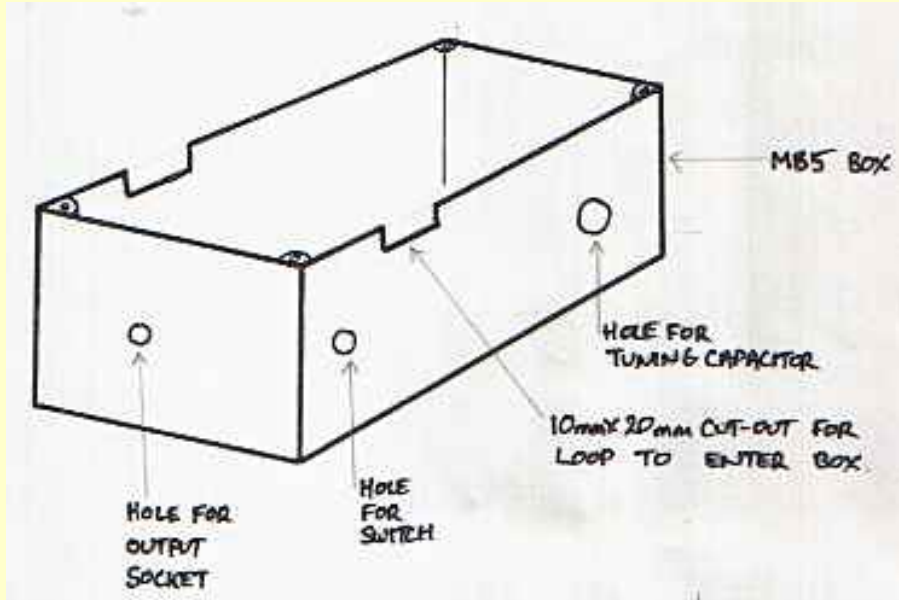

A suitable box with cut-outs to accommodate the entry of the loop into the box and holes for tuning capacitor, switch and output socket.

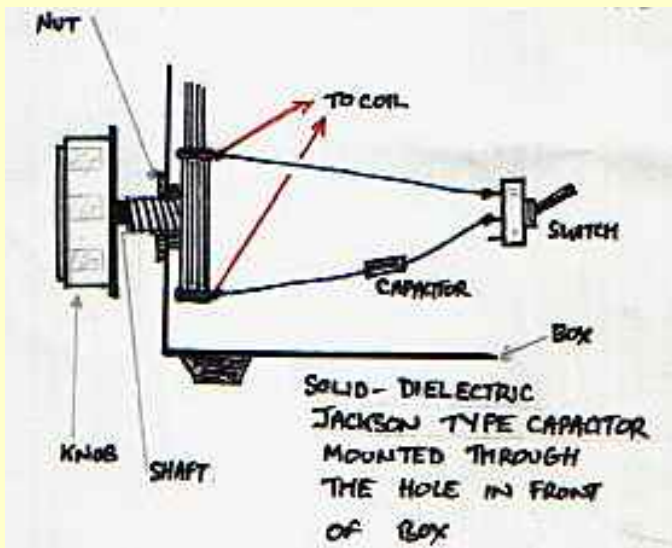

A solid Dielectric Jackson type tuning capacitor can simply be mounted through the front of the box and held in place with the brass nut.

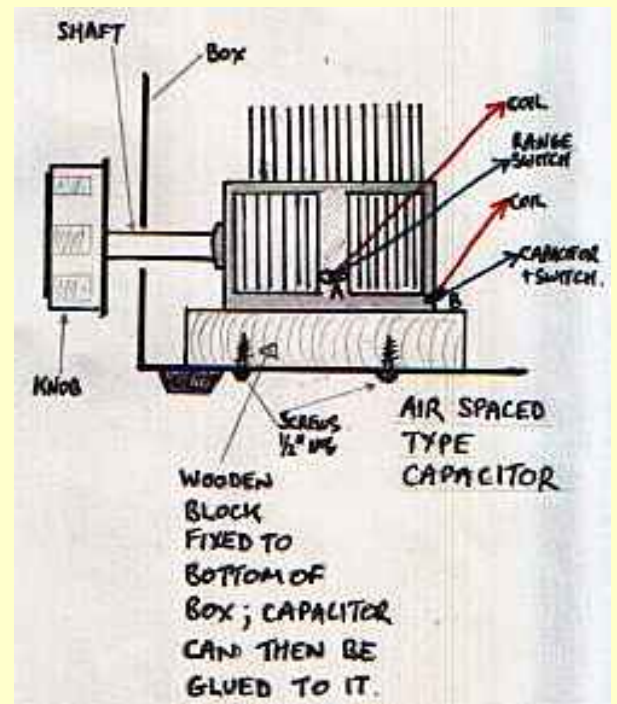

A traditional air-spaced tuning capacitor can be glued to a wooden block using Araldite which is then screwed to the bottom of the box.

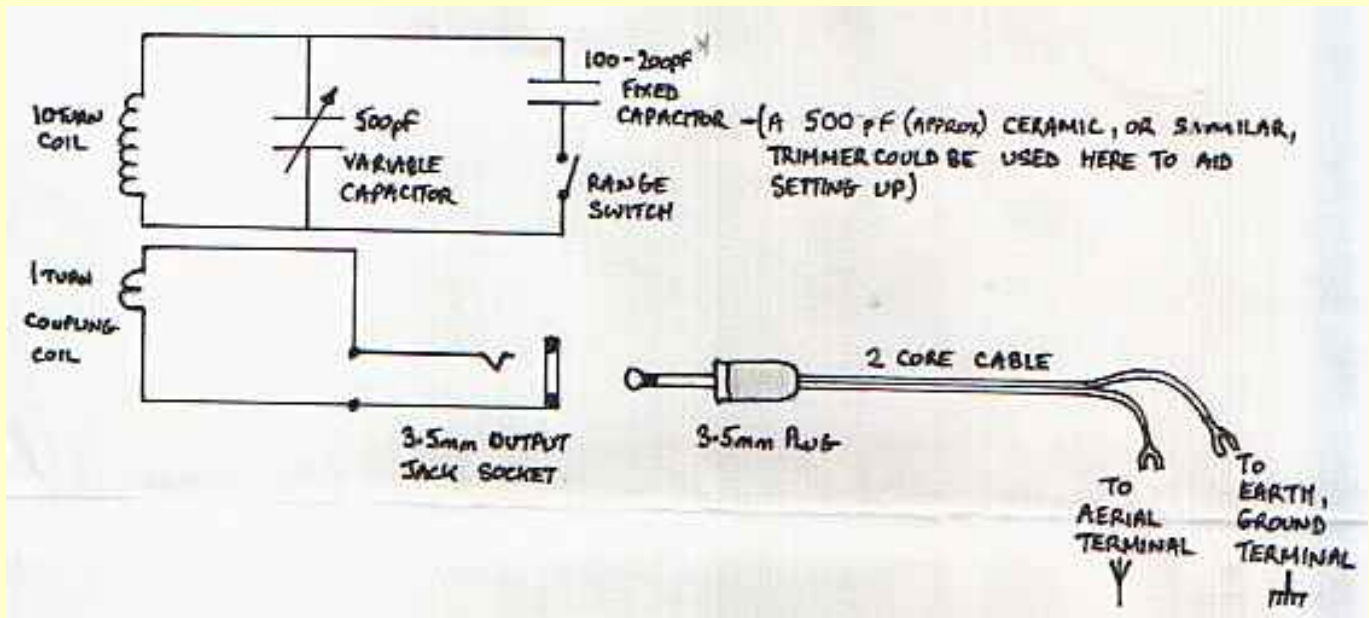

Connecting a loop to a radio receiver or Hi-Fi tuner

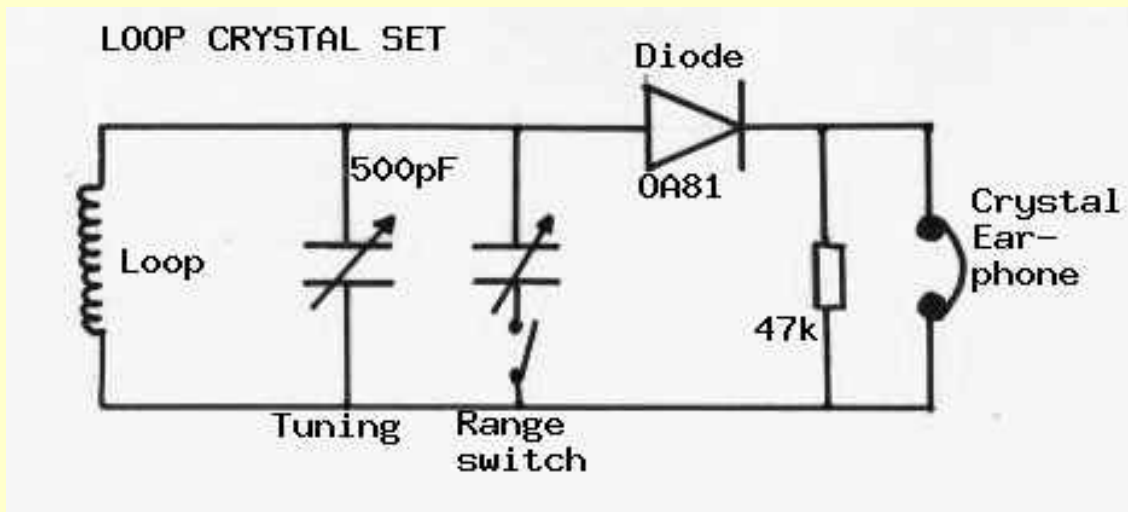

The circuit diagram above is an interesting modification to the loop aerial, and can be made to any loop aerial. With the addition of a germanium diode (not silicon) such as an OA81, OA91 or OA47, a 47k ohm resistor and a crystal earphone, the loop aerial becomes a portable crystal set which is quite effective given sufficient signal strength at your locality.



The photo on the left shows the finished loop in use, in this case merely placing the radio inside the loop will obtain much improved reception!

The loop is tuned to the required frequency with the tuning knob which will really peak up the reception.

Rotating the loop will maximise the signal strength &/or minimise co-channel or adjacent channel interference for clearer reception.

Using this loop I can hear distant local stations that would otherwise be completely impossible to receive and it helps improve reception on all other weak stations. It's a nice little project that produces a really useful listening aid.

Once you've built this little beauty you may want to try something a bit bigger.

Traditional loop aerials were built on a large wooden frame, about 1 meter across, and it is quite easy to make one, especially if you are



The Portable Loop in use!

handy with a few simple woodworking tools. The information below gives a few tips. Essentially a big loop is just the same as this portable loop but bigger, so make sure you have room - and permission!

## MW and LW Frame Aerial

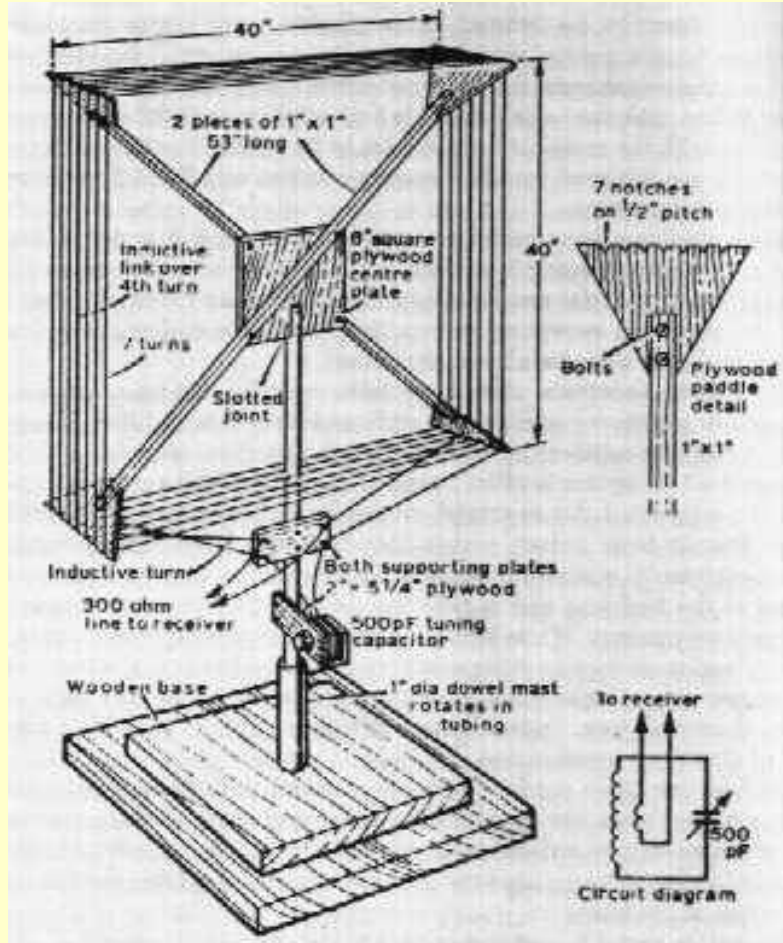

Constructional details

The illustration opposite was taken from a very old listening guide and shows the basic method of constructing a large frame for a bigger loop aerial. It is 40 inches (100cm) square and made of wood with the loop windings wound over the four plywood 'paddles'. I have tried this method and it works very well.

Certainly the increased surface area really improves signal pick-up and is ideally suited to 'communications' receivers.

I have also experimented with different shapes, since 40 inches (100cm) can be a bit too wide for some small rooms. My favourite is taller than it is long and is hexagonal in shape being 150cm tall and 70cm wide.

For Medium Wave reception 9 turns are required for the main winding and for Long Wave reception about 30 turns are needed.

The coupling winding is 1 single turn.



**A Long Wave Loop Aerial**

**The photo on the left shows a Long Wave loop aerial. The windings are wound over the 'paddles' described above and consist of 31 turns plus the one coupling turn.**

**The frame is made from broom handles which are joined together using halving joints and a screw. The base is used for this aerial and a Medium Wave loop aerial and is made from an offcut of kitchen worktop which is dense and heavy. A block is screwed to the base with a hole bored in it to suit the diameter of the 'broom handle' frames.**

**The tuning capacitor, switch and sockets are neatly housed in a plastic enclosure of the same type as the one used for the portable loop described above.**

**This Long Wave loop is only 55cm wide and is easily accommodated in a small 'box room'.**



**A close up photo showing the 'control box' and the joint of the broom handles that for the frame. The loop windings which are first taken to a tag-strip and soldered in place before the wires are taken into the control box, this help keep the windings taugt.**

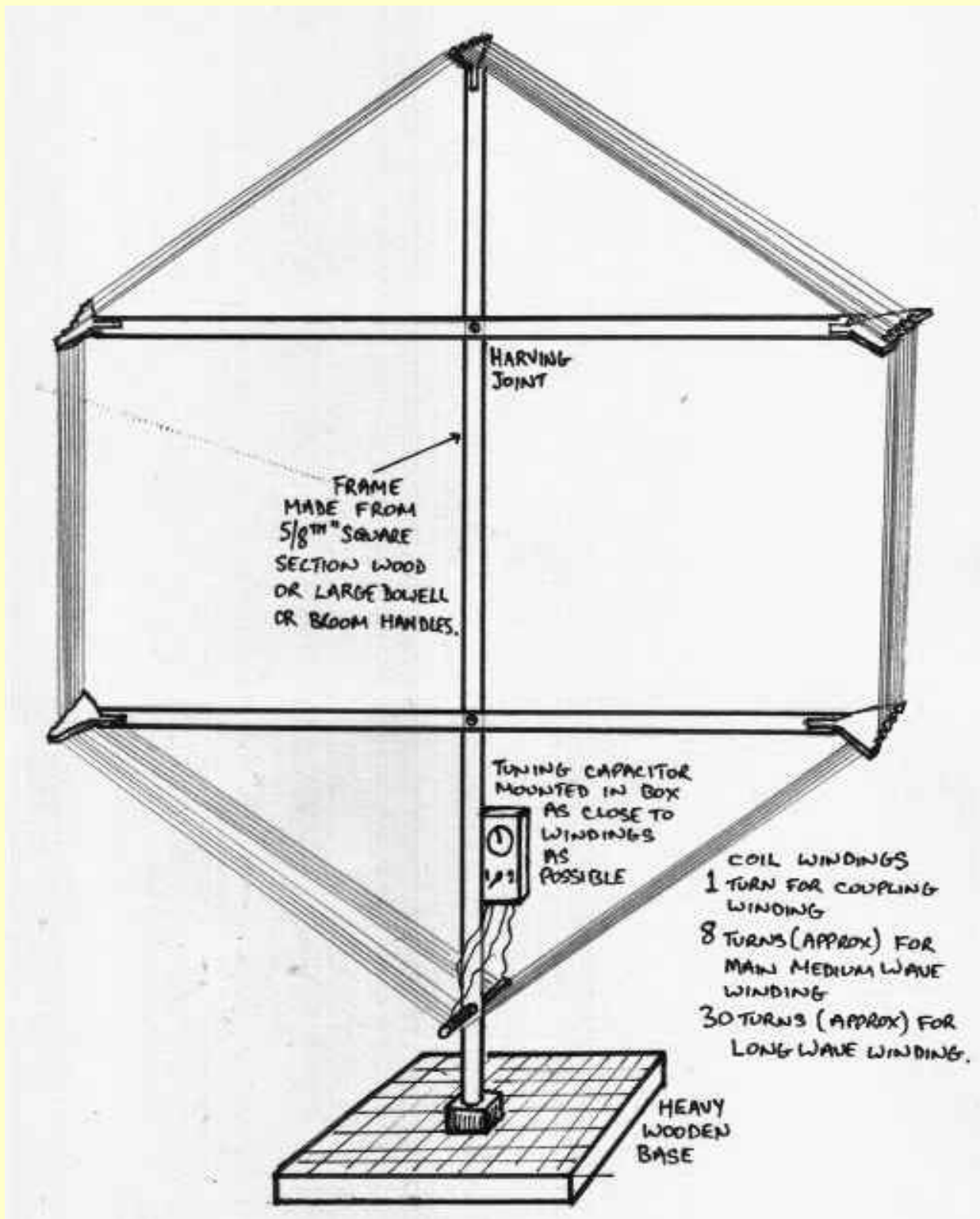

**Diagram of Long Wave Loop**

So there you are - LOOP AERIALS - cheap and very easy to make. The portable loop certainly looks the part, being very neat and tidy. The larger frame aerials are by their very nature more obtrusive, but can be more effective at collecting radio wave energy due to their extra size. If construction is kept neat and tidy with the rough edges rounded off and the controls housed in a neat box a big loop need not be a major eye-sore.

**Good Luck with YOUR loop aerial and happy LW and MW DX-ing!**

**Next I'll take a look at Antenna Tuning Units which will help match your long random wire aerial to your radio. ATU's, as they are known, will help with Short Wave reception as well as Long and Medium Wave too:**

**[To ATU's \(ANTENNA TUNING UNITS\)](#)**



Home Page

**DX-ing and Short Wave Radio**



Radio Stations and Memorabilia

**Antenna Tuning Units (ATUs)**



**Make A Signal Meter**



[Home](#) | [Contact](#) | [Site Map](#) | [Reciprocal Links & Credits](#) | [Thank You](#)

MDS975.co.uk © 2004



# Magnetic Loop Antenna Experiments

by Jeff Imel, K9ESE

## General Overview

Last month, I began looking for ways of lowering the noise floor at my QTH. Talking with several area amateur radio operators, I learned that many of us were experiencing daytime noise floors that exceeded S-6 and sometimes increased to as high as S-9. I was looking for antenna ideas that may help attenuate the noise floor without compromising received signal strength too much.

Magnetic loops popped up early in my research and I learned that a magnetic loop is a high-Q tuned antenna that also possesses a narrow pass band that usually runs between 15 - 30 Hz. This high-Q and narrow pass band is beneficial as it significantly reduces off-frequency noise and typically receives less noise than a conventional antenna. The loop is a tuned circuit and it will act as a pre-selector for your receiver. The received signal that you are really interested in, but usually buried in the noise - will be more readable.

I thought, "Wow! This could be my answer!"

During my research, I found many Internet sites that proved to be helpful and educational. I can't take credit for the design of the loops I constructed as I used the website of Steve Yates, AA5TB, as my primary source of information. I encourage you to review his site at:

<http://www.qsl.net/aa5tb/loop.html>

**WARNING: Even at low RF levels the loop can exhibit several hundred volts and produce a large magnetic field. At higher RF levels, several thousands volts may be present on this antenna. Exercise caution when building and using this antenna. Build this antenna at your own risk.**



[Jeff Imel, K9ESE](#) has been licensed since 1977. He lives with his family in Muncie, Indiana where he enjoys CW, QRP, and playing with magnetic loop antennas. He is ECI-QRP #008 and a member of FISTS, QRP-ARCI, the Flying Pigs, and ARS. Look for him when he is ARS BumbleBee #007 in the 2004 ['Flight of the Bumblebees'](#).

## Building the Loop

Building a magnetic loop antenna feels more like a small plumbing project as the principle building materials consists of copper water pipe and fittings that must be soldered ("sweated") together.

### Here are the parts and tools list to build a magnetic loop:

- (2) 10'  $\frac{3}{4}$ " copper water pipe
- (8)  $\frac{3}{4}$ " 45 degree copper couplers
- (1) Air Variable Capacitor, 2 gang, 370 pF per gang
- (1) 5 feet of RG-58U coax
- (1) PL-259 coax connector

### Miscellaneous Items:

- 12 or 14 gauge copper wire (1 foot)
- Rosin Core Solder
- Paste Flux
- 200 - 300 grit sandpaper or "0" steel wool
- Hammer Finish Paint

### Required Tools:

- Copper pipe cutting tool or hack saw
- Propane Torch
- Eye protection
- Diagonal cutters
- Wire Stripper
- (8) 2x4 cut to 6" in length

I built two loops. One loop is 38" in diameter and uses 8 pieces of copper pipe cut to 13.5" long. It tunes from 10 to 40 meters. The second loop is 64" in diameter and uses 8 pieces of copper pipe cut to 24" long and it tunes from 10 to 80 meters.

Construction of the loop is straightforward. Cut the 10 foot sections of copper pipe into 8 equal lengths. Clean the ends of the copper pipes and the 45-degree fittings with sand paper and alcohol. Remove the bar code stickers from the copper while you are at it. Lay the copper tubes and connectors on the ground so that they form an octagon. One of these copper tubes will be the top of your loop and is where your air variable capacitor will be mounted. Measure a tube and indicate the exact center. If your tube is 13.5 inches long, then the exact center will be 6.75 inches from each end.

Mark the center of the tube with a marker. Measure  $\frac{1}{2}$  inch from each side of this mark, and mark the tube again. Now cut this tube of the two marks you just made. This will leave two tubes that are 6.25" long. This is the top tube where you will connect your capacitor. Cut a 2x4 into 8 - six inch pieces. Flux both the copper tubes and join the tubes with the 45-degree connectors. You will now have an octagon that has a 1-inch opening on one side. Place a 2x4x6 under each side of the octagon, raising the loop off of the ground. Make a few more checks of your loop insuring that each joint is firmly seated inside of each 45-degree connector and that your loop looks like a nice shaped octagon.

Looking cool already, huh?

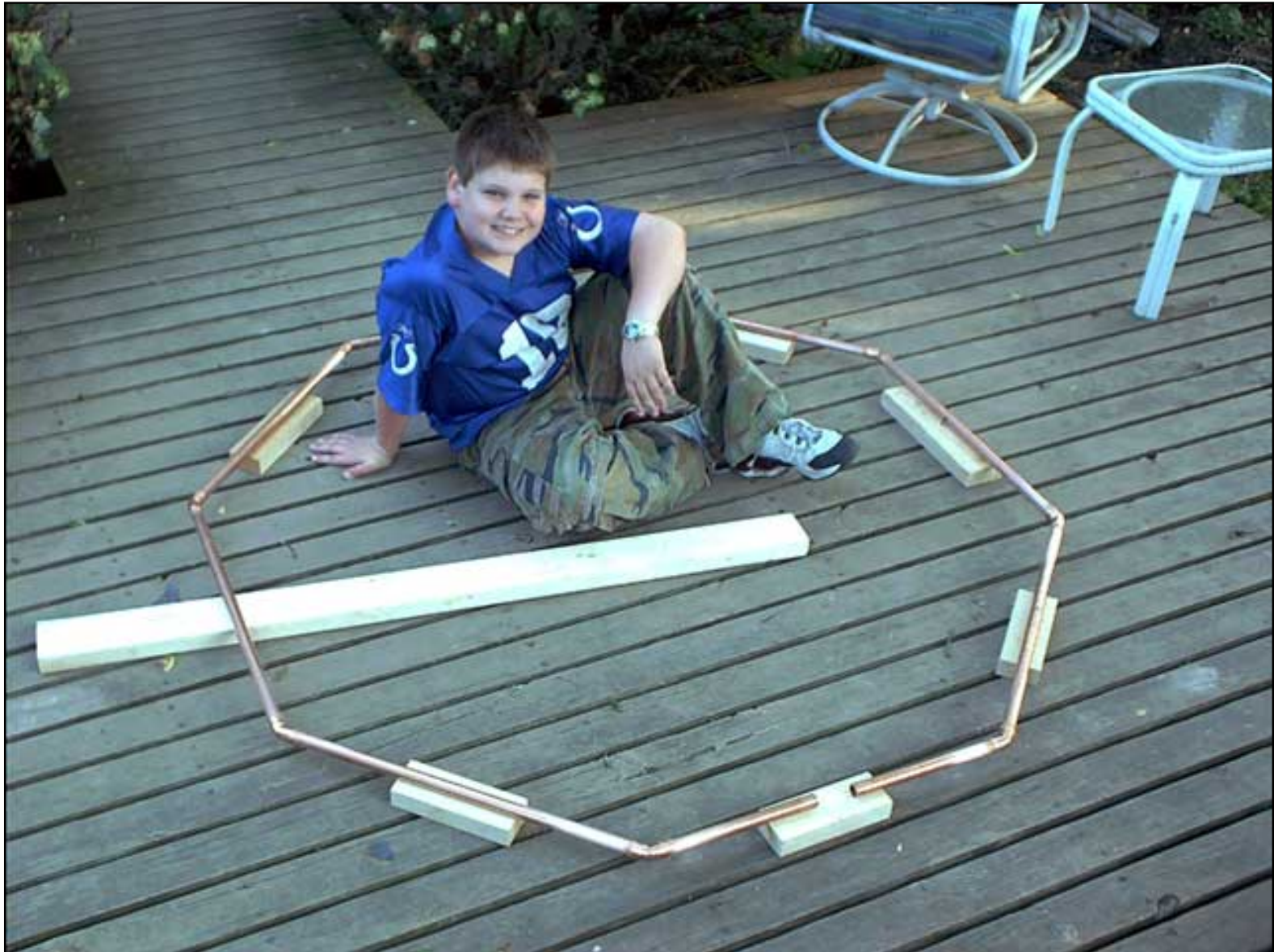

With your propane torch and your rosin core solder, solder the pipes and joints together. Be patient and don't rush the soldering. After you are finished, give your loop a good 10 to 20 minutes to cool down. Cooper is a great conductor of heat and it is amazing how long the loop will stay warm.



While your loop is cooling, you can construct the Faraday Loop. The Faraday Loop is not physically connected to the copper loop. It interacts and couples with the copper loop through magnetic flux. I use RG-58 coax to construct the loop. This diameter of this loop should be exactly 20% of the diameter of the larger loop. If your copper loop is 38" in diameter, then your Faraday Loop will be 7 5/8" in diameter.

The drawing will give you an idea how to construct the Faraday loop. At the top part of the loop, the inner conductor is attached to the outer conductor. At the bottom of the loop, the outer conductors are soldered together. Using electrical tape, tape up the connections neatly and you'll have a completed Faraday Loop.

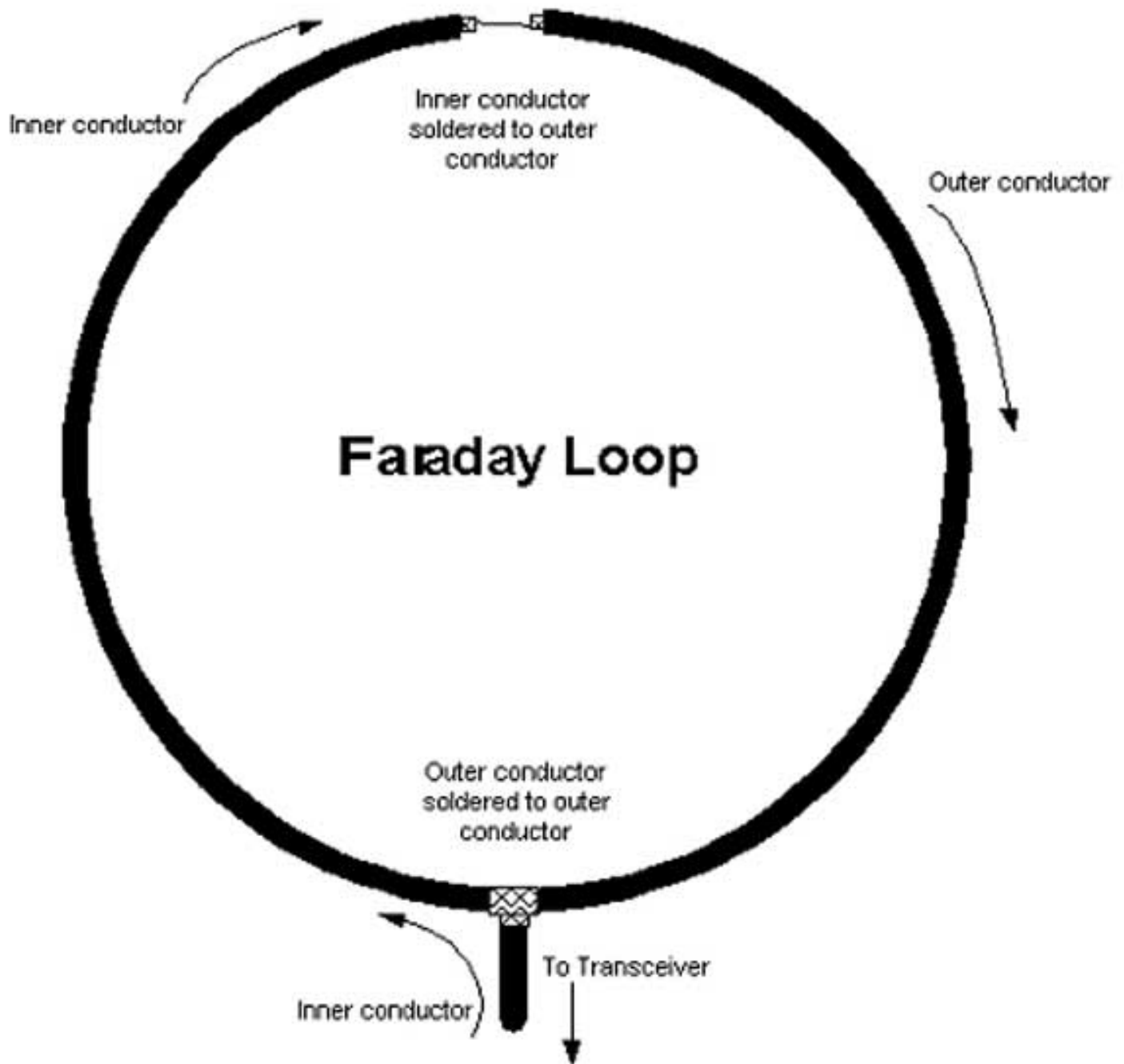

Your copper loop should be cool by now, so now you can attach the capacitor. I used a two gang, air variable capacitor rated at about 500 volts. It came out of an old broadcast band receiver. You can use much more expensive vacuum variable or butterfly capacitors if you wish. Plan to spend \$100 to \$300 if you go this route. Since I'm using less than 5 watts and just wanted to get the antenna on the air to try it out, I used a capacitor from my junk box.

Connect and solder one side of the copper loop to one gang and the other side of the copper loop to the other gang. Install a large knob of some sort on the capacitor shaft for tuning ease.

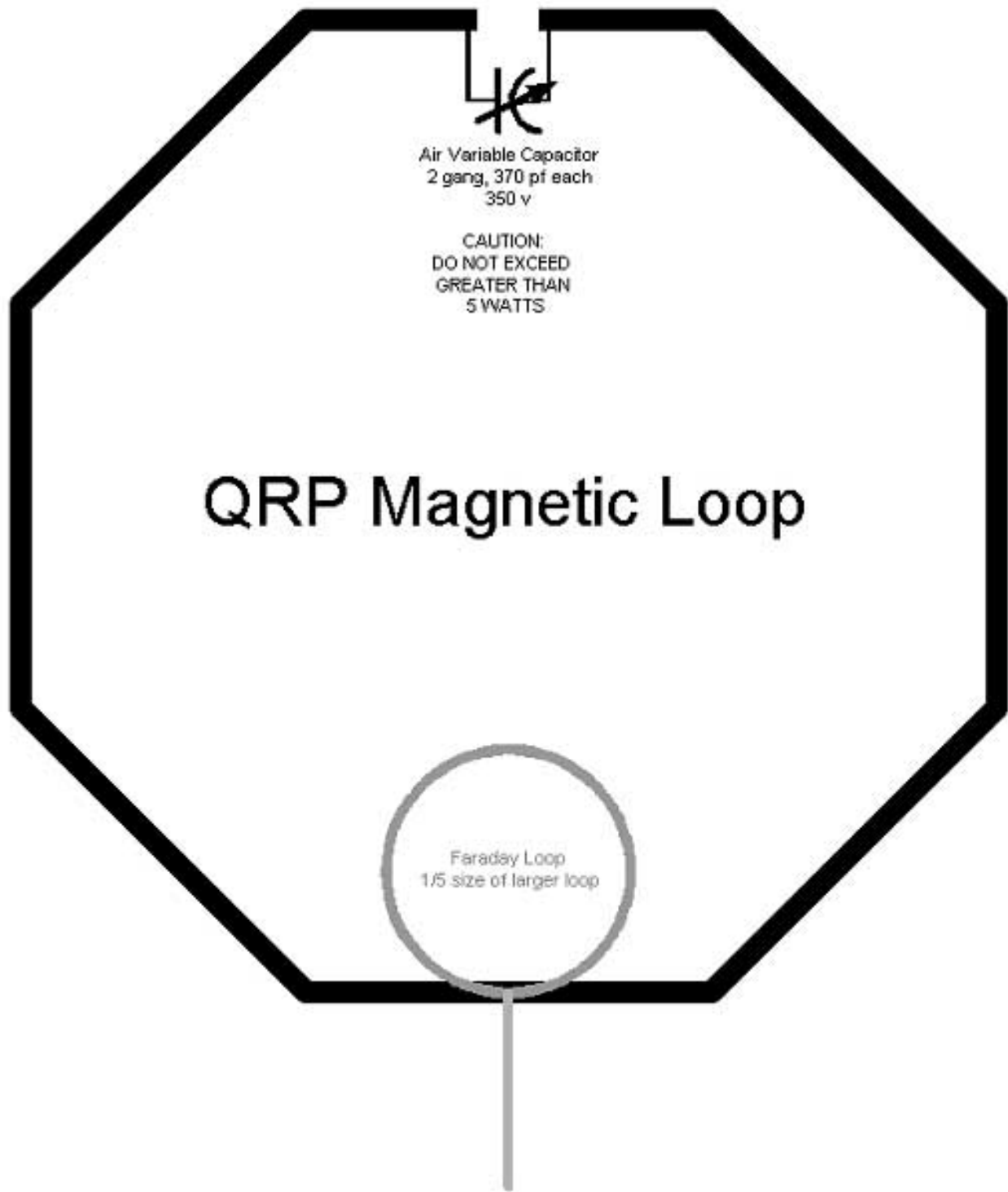

Using electrical tape or plastic wire ties, attached the Faraday Loop to the bottom of the copper loop.

You can construct a really nice loop stand from PVC pipe or you can use a wood ladder to support your loop. I used a wood ladder as a temporary support.

For cosmetic purposes, I painted my 38" loop with black hammer finish paint. Without a protective coating, the copper pipe will oxidize and turn green. The hammer paint does a great job in not only protecting the copper, but it also gives your loop a really cool looking finish. Hammer finish paint is available at Wal-Mart in the spray paint section.

## Tuning

You must have an antenna analyzer. Forget about trying to tune the loop without one. I used an MFJ antenna analyzer. I connected the analyzer to the Faraday Loop, set my analyzer for the proper frequency and adjust the variable capacitor on the loop. You will find the tuning to be sharp and be warned, your body will interact with the loop.



Through experience, you will find how much your body detunes the loop and you can eventually compensate for this effect. I'm able to get 1.2:1 or better with about 40 Hz bandwidth at 2:1 or better.

## Performance

My noise floor dropped 3 to 5 S-units while received signals only dropped 1 S-Unit as compared to a center fed zepp antenna.

What a difference!

Signals that were in the noise popped out of the noise using the loop. On 20 meters using the 38" loop I'm able to work most stations that are heard. On 40 meters, my signals reports were equal to or slightly less than reports using my center fed zepp. The loop does a great job in reducing noise, increasing my listening comfort and bringing out signals buried in the noise.

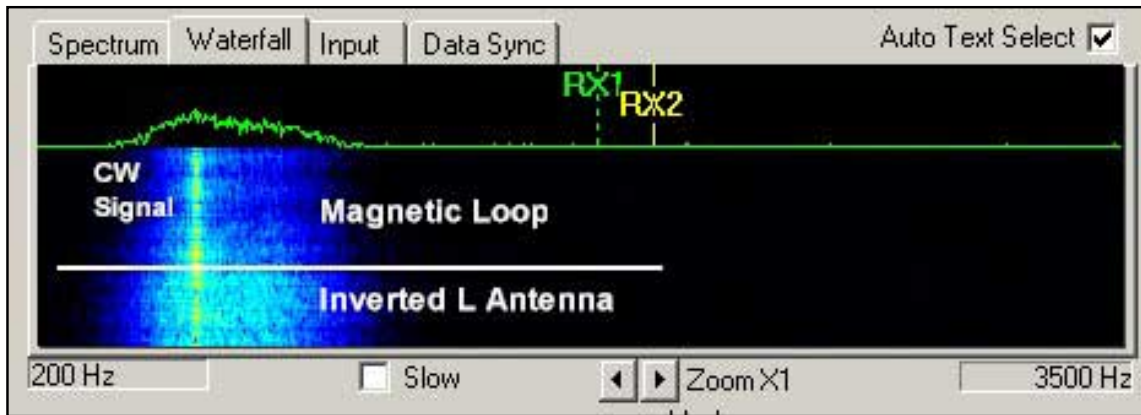

**Figure 1. Inverted-L at 40 feet compared to a magnetic loop at 2 feet above the ground**

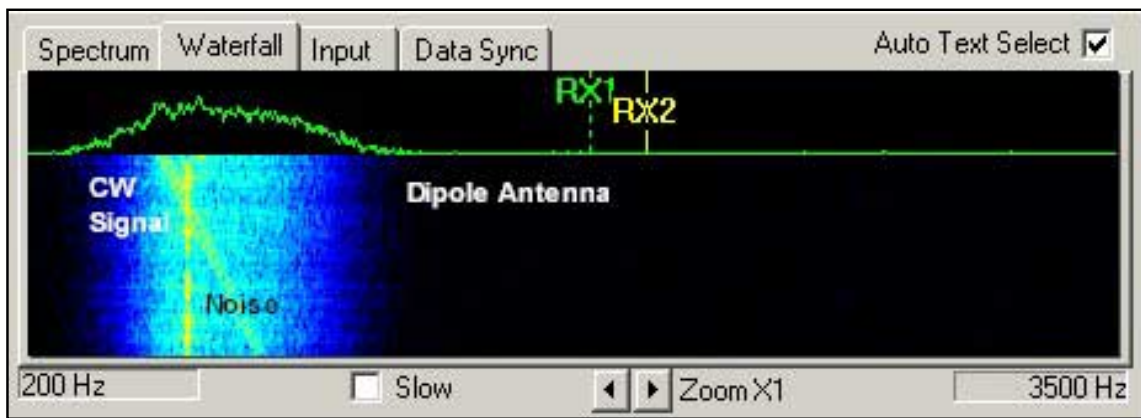

**Figure 2. 40 meter dipole antenna a 25 feet. My S-meter was indicating S-7 of noise**

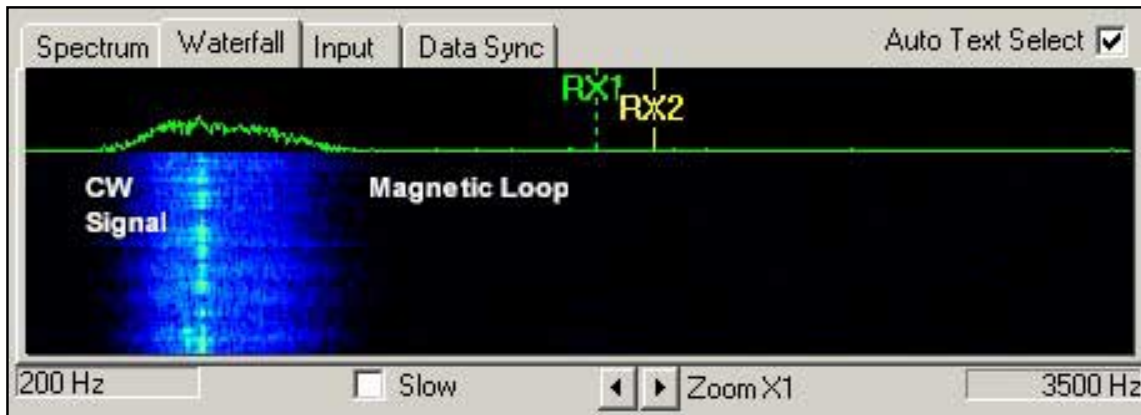

**Figure 3. Same signal as in Figure 2. Receiver was switched over to a 62" magnetic loop mounted 18 inches about the ground. Noise is now down to S-3.**

I built a larger loop with a 62" diameter for use on 40 and 80 meters. It tunes 1:1 SWR on 40 meters. Signal reports are better than my zepp when stations are more than 750 miles away. It seems that the loop has a much lower angle of radiation than the zepp.



The loop is directional--acting like two co-phased verticals. If I want to work the west coast, I make sure that the loop is positioned with the vertical sections pointing East - West ... the loop is broadside to the North - South.

## Sources:

- <http://www.qsl.net/aa5tb/loop.html>
- <http://www.arrl.org/tis/info/Loop-H.html>
- <http://www.iri.tudelft.nl/~geurink/magnloop.htm>
- <http://www.qsl.net/mnqrp/Loop/index.html>
- <http://www.g3ycc.karoo.net/loop.htm>
- <http://www.g3ycc.karoo.net/rigs1.htm>
- <http://www.g3ycc.karoo.net/rock.htm>
- <http://www.alphalink.com.au/~parkerp/nodec97.htm>
- <http://www.qsl.net/pa3hbb/arframe.htm>

---

Back

Copyright © 2004 [Jeff Imel, K9ESE](#) All Rights Reserved  
May Not Be Reproduced in Any Form Without Written Permission

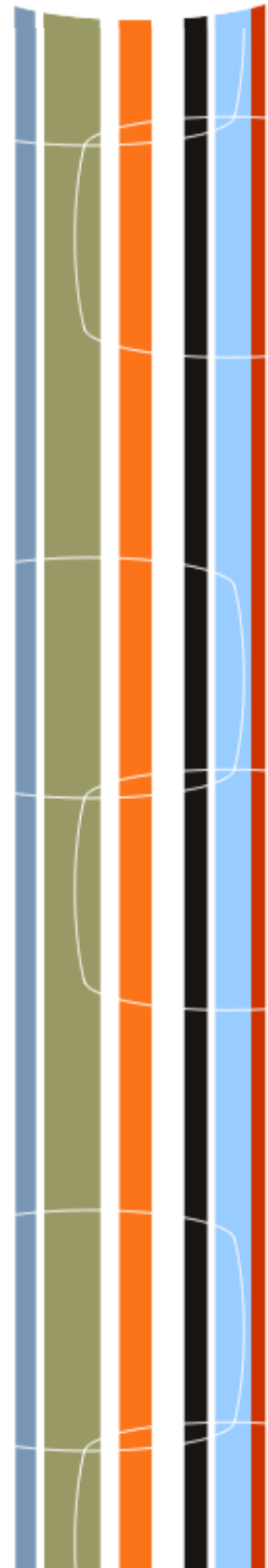

# AM ANTENNAS

## Internal AM Radio Antennas

Many portable AM radios rely on an antenna which is an internal part of the radio receiver. To improve reception, reorientate the radio by rotating it or moving it to a new location.

If problems continue, listeners can try attaching the end of the radio's indoor antenna wire to the earth terminal of the receiver to form a small loop, preferably positioned vertically. This will reduce the overall signal strength, but will also significantly reduce interference.

Some radios, such as hi-fi tuners, come with an external AM antenna. Connecting the supplied antenna will provide the best reception.

## Outdoor AM Antennas

Outdoor antennas are less prone to electrical interference as they are situated away from household appliances. Although offering the best quality reception, outdoor AM antennas are not readily available from retailers as demand is low. Signal strength is usually strong within a radio station's coverage area, and antenna solutions for those outside the coverage area are specific to the individual location.

There is a variety of useful outdoor AM antenna configurations including:

[AM Booster](#)

[Long Wire](#)

Tuned Loop

Untuned Loop

Loop antennas are both technically complicated and relatively expensive to construct. In liaison with a professional antenna installer, listeners will find that in most instances a Long Wire or AM booster will resolve reception problems.

## AM Booster

The antenna inside most modern AM radios is a ferrite rod with a coil of wire wound around it. A booster in the form of a balance dipole antenna and ferrite coupler can be used to magnify incoming signals into an AM radio ferrite antenna to improve its reception.

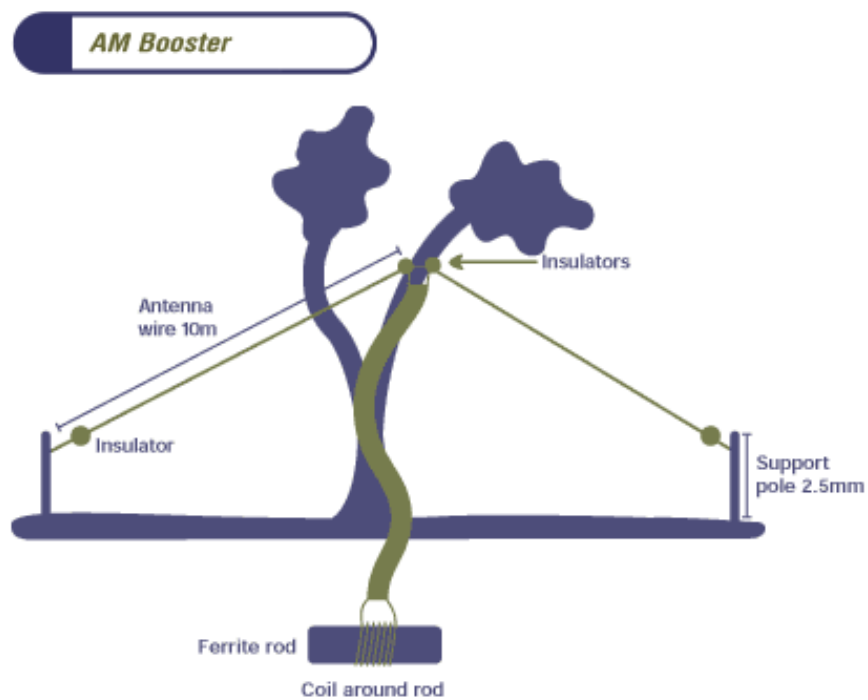

## Long Wire Antenna

The relatively simple long wire antenna can be used as an extension to a radio's existing antenna, or connected to the radio receiver terminals.

The basic long wire antenna system consists of:

Heavy gauge insulated wire or 4 gauge copper wire for the antenna.

Wire situated at least 2.5 metres high (ie above head height).

The wire should be at least 20 metres long with no joins.

Insulators are installed at each end of the wire to ensure the house and tree (or post) is isolated from the antenna.

The antenna should be placed away from any objects that may interfere with reception.

The feed line is soldered to the antenna wire. There must be a loop in the feed line just before it enters the house so rainwater drips off.

The feed line is connected to the antenna terminal of the radio. A separate wire runs from the earth terminal to an earth spoke.

If the radio does not have terminals, the feed line can be attached to the radio's own antenna.

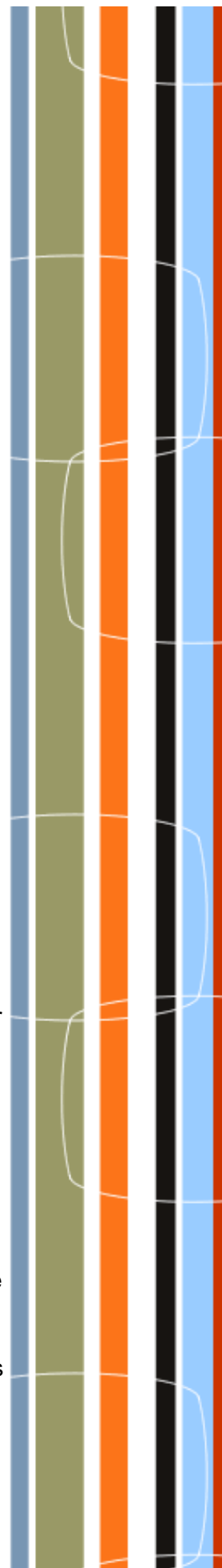

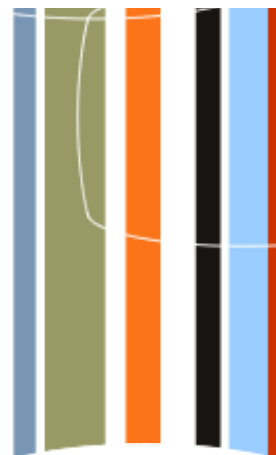
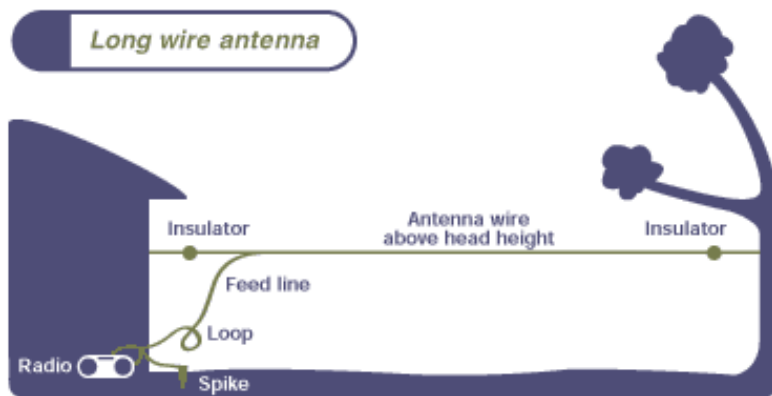

**Reception Adviceline**  
**1300 13 9994**



©2004 ABC | [Privacy Policy](#)

# LOOP ANTENNA

The loop antenna was designed using #14 stranded wire, similar to the one Casper Hossfield describes in the [April 2002 AAVSO Solar Bulletin](#).

## PARTS:

### HOME DEPOT

4	1 1/4" PVC	27 3/4"	
4	1 1/4" PVC	4 3/4"	
1	1 1/4 " PVC	6"	
3	1 1/4" PVC	90 DEG. ELBOW	C406-012
1	1 1/4 " PVC	TEE	C401-012
4	1 1/4 " PVC	END CAP	C447-012
1	1 1/4" PVC	CROSS	C420-012
1	1 1/4" PVC	MALE ADAPTER	C436-012
1	1 1/4" GALVANIZED FLOOR FLANGE		311 F-114
1	2' BY 2'	3/4" PLYWOOD	
1	500'	#14 STRANDED COPPER WIRE	

### RADIO SHACK

1	BOX	PART NO. 270-1801
---	-----	-------------------

1	BARRIER STRIP	PART NO. 274-656
1	SO-239 CHASSIS SOCKET	PART NO. 278-201
1	50' CABLE	PART NO. 278-971
1	1/8" MONO PLUG	PART NO. 278-227





### ASSEMBLY:

When connecting the PVC lightly sand both ends before applying PVC cement.

Install the four 27 3/4" 1 1/4" PVC to the cross.

Install the tee, as per the picture, to one of the 27 3/4" sections. On the bottom.

Install the three elbows, as per the picture, to the three remaining 27 3/4" sections.

Install the 4 3/4" PVC to the elbows, and the tee.

Install the 1 1/4" caps, do not cement the one on the tee at this time. This is so you can have access to the wires when pulling them to the center of the cross.

Install the 6" PVC to the bottom of the tee.

Install the male adapter to the bottom of the 6" PVC.

Install the floor flange to the center of the 2' by 2' plywood.

Drill a hole, in the 4 3/4" section connected to the tee, large enough to push the #14 wire through, next to the tee, on the underside. Also drill one next to the cap, on the underside.

Feed about 4' of the #14 wire into the hole next to the tee, this will be pulled up to the center of the cross, on the inside of the PVC.

Wrap the #14 wire around the 4 3/4" sections 21 times. Cut wire leaving about 4' to feed

into the hole next to the cap.

Feed the 4' of the #14 into the hole next to the cap, on the tee 4 3/4" section.

Drill a hole large enough to pull two #14 wires in the back center of the cross.

Push the wires on the inside of the PVC up to the center of the cross, do this through the male adapter, pull the wires out the hole in the back center of the cross.

Cement the cap on the 4 3/4 tee section.

Screw the antenna assembly to the floor flange on the plywood 2' by 2'.

Mount the barrier strip on the inside bottom of the box, 3" length of the box, with super glue.

Drill a hole in the bottom of the box, above the barrier strip, to bring the two #14 wires from the cross, into the box. Pull the two #14 wires into the box, cut and hook up to the barrier strip.

Super glue the box to the cross.

Mount the SO-239 socket on the lid of the box so that it does not hit the barrier strip when installed on the box. Wire the socket to the antenna wires on the barrier strip.

For 24 khz use .0276 ufd of capacitance to tune the loop. Hook this across the antenna leads on the barrier strip.

Cut off one of the PL-259 plugs on the 50' lead in cable, and install the 1/8" mono plug. This will plug into the Gyrator II receiver.



Capacitance to tune the loop for other frequencies.

khz	ufd
21.4	.0346
24	.0276
24.8	.0257
26.1	.0233
27	.0218
30.6	.0166

**RETURN**

[Home](#)[Product selection](#)[Specifications](#)[Value added](#)[Order form](#)[Request quote](#)[Contact us](#)[HAM Pricing](#)[Search](#)

## BROADBAND TRANSFORMERS: FERRITE RODS, BARS, PLATES AND TUBES

Ferrite rods, bars, plates and tubes are primarily used in radio antennas and chokes. They are available in materials from permeability of 20 to 10,000. However, only rods with #61 ( $\mu_i = 125$ ), and #33 ( $\mu_i = 800$ ) materials are standard stocking items. All other materials are custom manufactured, but readily available with lead time for delivery.

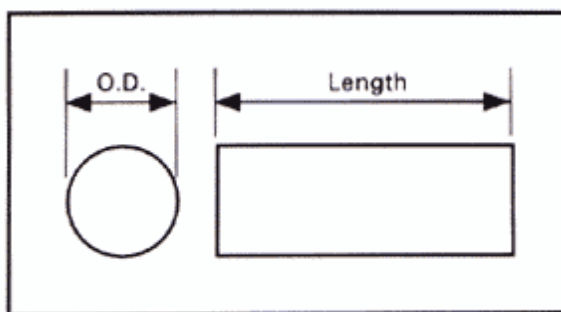

### STANDARD STOCKING RODS

Part number	Material	Permeability	Diameter (in)	Length (in)	$A_L$ value mh/1000 t	Ampere turns
R61-025-400	61	125	0.25	4.0	26	110
R61-037-300	61	125	0.37	3.0	32	185
R61-050-400	61	125	0.50	4.0	43	575
R61-050-750	61	125	0.50	7.5	49	260
R33-037-400	33	800	0.37	4.0	62	290
R33-050-200	33	800	0.50	2.0	51	465
R33-050-400	33	800	0.50	4.0	59	300
R33-050-750	33	800	0.50	7.5	70	200

Other Dimensions and materials are available. Please call for your other requirements.

**FERRITE RODS** are available as standard stocking item in various sizes in the #33 and #61 materials. Ferrite rods of other materials are available with lead time. The most common use of a ferrite rods is for antennas and choke applications.

**ANTENNAS:** Ferrite Rods are widely used as loop antenna such as broadcast-band receivers, direction-finder receivers, etc. The #61 material rods are widely used for commercial AM (550 KHZ to 1600 KHz) radio antenna and by radio amateurs (2 MHz to 30 MHz). The #33 material rods are more suitable for very low frequency range ( 100 KHZ to 1 MHz). The table on next page lists the recommended frequency range for a few different materials.

To calculate the inductance or number of turns, please use the formula below:

$$N = 1000 \sqrt{\frac{\text{desired 'L' (mh)}}{A_L \text{ (mh/1000 turns)}}} \quad L(\text{mh}) = \frac{A_L \times N^2}{1,000,000} \quad A_L(\text{mh/1000 turns}) = \frac{1,000,000 \times 'L' \text{ (mh)}}{N^2}$$

N = number of turns      L = inductance (mh)      A<sub>L</sub> = inductance index (mh)/1000 turns

Loop antenna has a height factor called effective height,  $h_e$  ( in m ) , which when multiplied with field strength, F (in  $\mu\text{V/m}$ ), provides the loop-induced voltage (in  $\mu\text{V}$ ).

$$h_e = \frac{2\pi N A \mu_e}{\lambda}, \text{ in meter.}$$

$$\text{Loop Induced Voltage} = F h_e = \frac{2\pi N A \mu_e F}{\lambda}, \text{ in } \mu\text{V.}$$

Where N = no. of turns  
 A = area in square meter (m<sup>2</sup>)  
 $\lambda$  = wavelength in meter  
 $\mu_e$  = effective permeability of rod  
 and where  $d/\lambda < 1$ , d = diameter of rod

It can be seen from the equation that the highest induced voltage occurs when the windings occupied the entire rod (when N is largest).

Initial Permeability, $\mu_i$	Maximum Permeability, $\mu_m$	Saturation Flux Density, Bs, at 13 Oe	Recommended Frequency *Range (MHz)	Amidon Material
20	—	2000 at 40 Oe	80-100	68
40	—	3000 at 20 Oe	10-80	67
125	450	2350	5.0-30	61
250	375	2200	0.05-4	64
300	3600	3900	0.001-5	83
800	3000	2750	0.01-7	33
2000	4600	1150	0.001-2	77

\* Frequency ratings are for optimum Q in narrow-band tuned circuits.

**CHOKE applications:** Both the #33, and the #61 rods are used extensively in choke applications. The #33 material should be selected for the 3.75 - 7.5 MHz (40-80 meters band). The #33 rods are also often used in speaker cross-over networks. The #61 material is most suitable for the 7.5-30 MHz ( 10-40 meters band) range. Due to the open magnetic structure of the rod confide ration, considerable current can be tolerated before it will saturate.

There are several factors that have a direct bearing on the effective permeability of a ferrite rod, which in turn will effect inductance and 'Q', as well as the A<sub>L</sub> value of the rod and its ampere-turns rating. These are: (1) Length to diameter ratio of the rod, (2) Placement of the coil on the rod, (3) Spacing between turns and, (4) Air space between the coil and the rod. In some cases, the effective permeability of the rod will be influenced more by a change in the length to diameter ratio than by a change in the initial permeability of the rod. At other times, just the reverse will be true.

Greatest inductance and A<sub>L</sub> value wail be obtained when the winding is centered on the rod rather than placed at either end. The best 'Q' will be obtained when the winding covers the entire length of the rod.

Because of all of the above various conditions it is very difficult to provide workable  $A_L$  values.

However we have attempted to provide a set of  $A_L$  and NI values for various types of rods in our stock. These figures are based on a closely wound coil of #22 wire, placed in the center of the rod and covering nearly the entire length. Keep in mind that there are many variables and that the inductance will vary according to winding technique.

#### EFFECTIVE PERMEABILITY

Coil placements and the length of windings on the rods, bars, plates and tubes affect the effective permeability of these devices. The corrected permeability for variation in coil length versus rod length is:

$$\mu' = \mu_e \sqrt[3]{(\ell_r / \ell_c)}$$

Where  $\mu'$  = corrected  $\mu$ ,  
 $\mu_e$  = effective permeability from the chart  
 $\ell_r$  = rod length in cm or inches  
 $\ell_c$  = length of coil windings in cm or inches

#### EFFECTS ON 'Q'

The spacing between the turns has a significant effect on the 'Q', and the inductance of the rods. The best values of 'Q' are obtained when the coil turns are spaced one wire diameter apart, with the windings located at the center of the rod. Litz wire provides the highest level of 'Q'.

Reference: "Ferromagnetic Core Design Handbook" by Doug DeMaw.

Initial Permeability, $\mu_i$	Maximum Permeability, $\mu_m$	Saturation Flux Density, Bs, at 13 Oe	Recommended Frequency * Range (MHz)	Amidon Material
20	-	2000 at 40 Oe	80-100	68
40	-	3000 at 20 Oe	10-80	67
125	450	2350	5.0-30	61
250	375	2200	0.05-4	64
300	3600	3900	0.001-5	83
800	3000	2750	0.01-7	33
2000	4600	1150	0.001-2	77

\*Frequency ratings are for optimum Q in narrow-band tuned circuits.

Except for those rods (#61 & #33) listed on previous page, the following plates, rods, tubes and strips listed below are non stocking items. Non stocking items are custom manufactured parts with lead times. Please call for information on pricing and delivery. Those stocking item rods can be shipped out immediately. The materials available are: #68 ( $\mu_i = 20$ ), #67 ( $\mu_i = 40$ ), #61 ( $\mu_i = 125$ ), #33 ( $\mu_i = 800$ ), #77 ( $\mu_i = 2000$ ), #73 ( $\mu_i = 2500$ ), #F ( $\mu_i = 3000$ ), #J ( $\mu_i = 5000$ ), and #W ( $\mu_i = 10,000$ ). The rods, tubes and strips can be manufactured with different length up to a maximum of 12 inches. The dimensional tolerances for rods, tubes and strips are approximately  $\pm 6\%$ , and for plates are  $\pm 2\%$ . All length tolerances are  $\pm 2\%$ . The camber tolerance is .011 per inch.

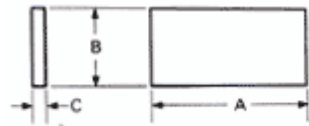

FIGURE 1

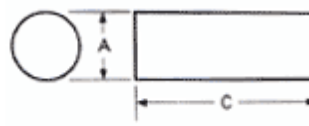

FIGURE 2



FIGURE 3

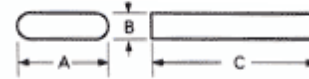
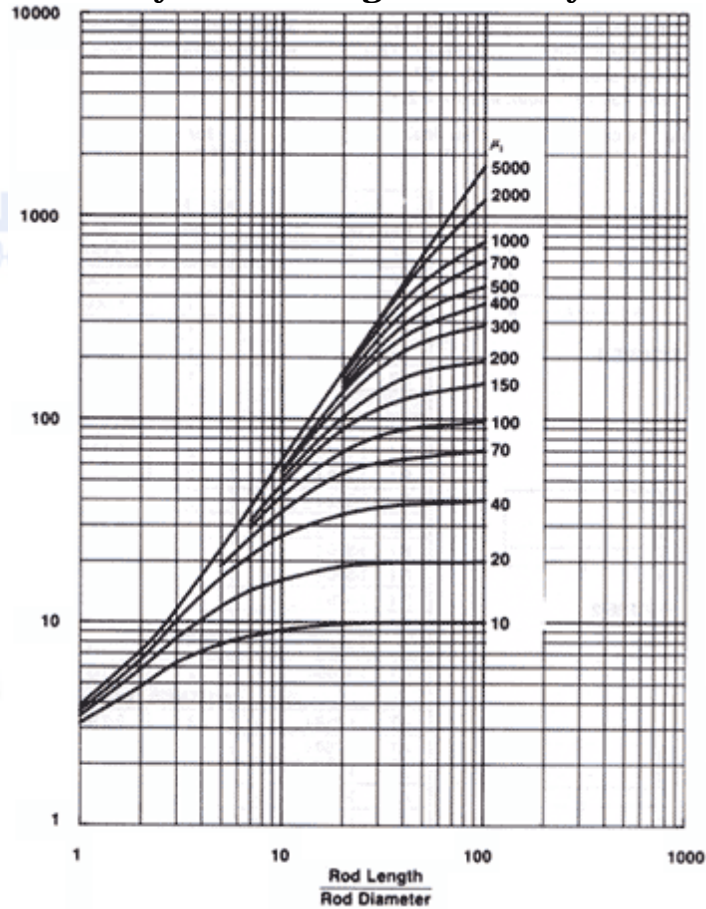

FIGURE 4

All dimensions in inches					
ANTENNA PLATES					
	PART NO.	FIG.	A	B	C
Fig. 1	AP ( )-1070	1	2.187	1.437	0.187
	AP ( )-1049-1	1	3.500	3.500	0.250
	AP ( )-996	1	4.500	4.500	0.250
	AP ( )-1053	1	5.500	2.750	0.375
	AP ( )-1051	1	5.500	5.500	0.500
	AP ( )-1052-2	1	13.000	2.125	0.250
ANTENNA RODS					
Fig. 2	R ( )-125-( _ _ )	2	0.125		7.500
	R ( )-187-( _ _ )	2	0.187		7.500
	R ( )-250-( _ _ )	2	0.250		7.500
	R ( )-312-( _ _ )	2	0.312		7.500
	R ( )-330-( _ _ )	2	0.330		7.500
	R ( )-375-( _ _ )	2	0.375		7.500
	R ( )-500-( _ _ )	2	0.500		7.500
	R ( )-625-( _ _ )	2	0.625		7.500
	R ( )-750-( _ _ )	2	0.750		7.500
	R ( )-875-( _ _ )	2	0.875		7.500
	R ( )-1000-( _ _ )	2	1.000		7.500
ANTENNA TUBES					
Fig. 3	AT ( )-218-( _ _ )	3	0.218	0.063	7.500
	AT ( )-250-( _ _ )	3	0.250	0.125	7.500
	AT ( )-375-( _ _ )	3	0.375	0.125	7.500
	AT ( )-500-( _ _ )	3	0.500	0.250	7.500
	AT ( )-750-( _ _ )	3	0.750	0.375	7.500
	AT ( )-875-( _ _ )	3	0.875	0.431	7.500
	AT ( )-1000-( _ _ )	3	1.000	0.500	7.500
	AT ( )-1250-( _ _ )	3	1.250	0.500	7.500

ANTENNA STRIPS					
Fig. 4	AS ( )-350-( _ _ )	4	0.350	0.200	7.500
	AS ( )-480-( _ _ )	4	0.480	0.125	7.500
	AS ( )-725-( _ _ )	4	0.725	0.125	7.500
	AS ( )-780-( _ _ )	4	0.780	0.165	7.500
	AS ( )-1000-( _ _ )	4	1.000	0.090	7.500
	AS ( )-1000-( _ _ )	4	1.000	0.375	7.500
	AS ( )-1250-( _ _ )	4	1.250	0.250	7.500
	AS ( )-1375-( _ _ )	4	1.375	0.250	7.500

**Rod Permeability vs. Rod Length divided by Rod Diameter**



This family of curves shows the value of the effective permeability of a ferrite rod as a function of its length to diameter ratio, as well as a function of the material permeability of the rod. It illustrates that generally, a great difference exists between the material permeability and the effective permeability of a rod. It also illustrates how, in some instances, the effective permeability of a rod can be influenced by changing its mechanical dimensions, more than by changing its material permeability, while in other cases, the reverse is true.

[Back to Product Selection](#)

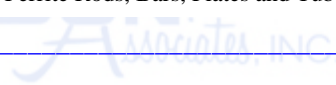

**Amidon Inc.**

240 Briggs Ave. Costa Mesa, California 92626 USA  
Call Toll Free: 800-898-1883, or 714-850-4660 | Fax: 714-850-1163  
Web: [www.amidon-inductive.com](http://www.amidon-inductive.com) | Email: [sales@amidon-inductive.com](mailto:sales@amidon-inductive.com)

**American  
Cores &  
Electronics**

**American  
Cores &  
Electronics**

**AMIDON** INDUCTIVE  
COMPONENTS

**AMIDON** INDUCTIVE  
COMPONENTS

**AMIDON**  
*Associates, INC.*

**AMIDON**  
*Associates, INC.*

**American  
Cores &  
Electronics**

**American  
Cores &  
Electronics**

**AMIDON** INDUCTIVE  
COMPONENTS

**AMIDON** INDUCTIVE  
COMPONENTS

## FERRITE RODS, BARS, PLATES AND TUBES

Ferrite rods, bars, plates and tubes are primarily used in radio antennas and chokes. They are available in materials from permeability of 20 to 10,000.

Only rods with #61 ( $\mu_i = 125$ ), and #33 ( $\mu_i = 800$ ) materials are standard stocking items. All other materials are custom manufactured, readily available with lead time for delivery.

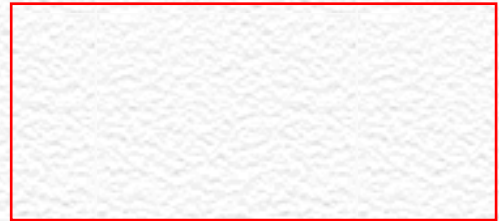

### Standard Stocking Rods

Part number	Material	Permeability	Diameter (in)	Length (in)	$A_L$ value mh/1000t	Ampere turns
R61-025-400	61	125	.25	4.0	26	110
R61-037-300	61	125	.37	3.0	32	185
R61-050-400	61	125	.50	4.0	43	575
R61-050-750	61	125	.50	7.5	49	260
R33-037-400	33	800	.37	4.0	62	290
R33-050-200	33	800	.50	2.0	51	465
R33-050-400	33	800	.50	4.0	59	300
R33-050-750	33	800	.50	7.5	70	200

Other dimensions and materials are available. Please call for your other requirements.



**FERRITE RODS** are available as standard stocking items in various sizes in the #33 and #61 materials. Ferrite rods of other materials are available with lead time. The most common use of a ferrite rod is for antenna and choke applications.

**ANTENNAS:** Ferrite Rods are widely used as loop antennas for such as broadcast-band receivers, direction-finder receivers, etc. The #61 material rods are widely used for commercial AM (550 KHz to 1660 KHz) radio antennas and by radio amateurs (2 MHz to 30 MHz). The #33 material rods are more suitable for very low frequency ranges (100 KHz to 1 MHz). The table below lists the recommended frequency ranges for a few different materials. Loop antennas have a height factor called effective height,  $h_e$  (in m), which when multiplied with field strength,  $F$  (in  $\mu\text{V}/\text{m}$ ), provides the loop-induced voltage (in  $\mu\text{V}$ ).

Where:

$N$  = number of turns

$A$  = area in square meters ( $\text{m}^2$ )

$\lambda$  = wavelength in meters

$\mu_e$  = effective permeability of rod, and

$d/\lambda < 1$ ,  $d$  = diameter of rod.

It can be seen from the equation that the highest induced voltage occurs when the windings occupied the entire rod (when  $N$  is largest).

Initial Permeability, $\mu_i$	Maximum Permeability, $\mu_m$	Saturation Flux Density, Bs, at 13 Oe	Recommended Frequency *Range (MHz)	AMI Material
20	--	2000 at 40 Oe	80-100	68
40	--	3000 at 20 Oe	10-80	67
125	450	2350	0.2-10	61
250	375	2200	0.05-4	64
300	3600	3900	0.001-5	83
850	3000	2750	0.01-1	43
2000	4600	1150	0.001-2	77

\*Frequency ratings are for optimum Q in narrow-band tuned circuits.

**CHOKE** applications: Both the #33, and the #61 rods are used extensively in choke applications. The #33 material should be selected for the 3.75 - 7.5 MHz (40-80 meters band). The #33 rods are also often used in speaker cross-over networks. The #61 material is most suitable for the 7.5-30 MHz (10-40 meters band) range. Due to the open magnetic structure of the rod configuration, considerable current can be tolerated

before it will saturate.

There are several factors that have a direct bearing on the effective permeability of a ferrite rod, which in turn will effect inductance and 'Q', as well as the  $A_L$  value of the rod and its ampere-turns rating. These are: (1) Length to diameter ratio of the rod, (2) Placement of the coil on the rod, (3) Spacing between turns and, (4) Air space between the coil and the rod. In some cases, the effective permeability of the rod will be influenced more by a change in the length to diameter ration than by a change in the initial permeability of the rod. At other times, just the reverse will be true.

Greatest inductance and  $A_L$  value will be obtained when the winding is centered on the rod rather than placed at either end. The best 'Q' will be obtained with the winding covers the entire length of the rod.

Because of all of the above various conditions it is very difficult to provide workable  $A_L$  values. However we have attempted to provide a set of  $A_L$  and NI values for various types of rods in our stick. These figures are based on a closely wound coil of #22 wire, placed in the center of the rod and covering nearly the entire length. Keep in mind that there are many variables and that the inductance will vary according to winding technique.

### EFFECTIVE PERMEABILITY

Coil placements and the length of windings on the rods, bars, plates and tubes affect the effective permeability of these devices. The corrected permeability for variation in coil length versus rod length is:



Where  $u'$  = corrected  $u$

$u_e$  = effective permeability from the chart

$l_r$  = rod length in cm or inches

$l_c$  = length of coil windings in cm or inches

### EFFECTS ON 'Q'

The spacing between the turns has a significant effect on the 'Q', and the inductance of the rods. The best values of 'Q' are obtained when the coil turns are spaced one wire diameter apart, with the windings located at the center of the rod. Litz wire provides the highest level of 'Q'.

Except for those rods (#61 & #33) listed above, the following plates, rods, tubes and strips are non-stocking items. Non-stocking items are custom manufactured parts with lead times. Please call for information on pricing and delivery. Those stocking item rods can be shipped out immediately. The materials available are: #68 ( $u_i = 20$ ), #67 ( $u_i = 40$ ), #61 ( $u_i = 125$ ), #33 ( $u_i = 800$ ), #77 ( $u_i = 2000$ ), #73 ( $u_i = 2500$ ), #F ( $u_i = 3000$ ), #J ( $u_i = 5000$ ), and #W ( $u_i = 10,000$ ). The rods, tubes and strips can be manufactured in lengths up to a maximum of 12 inches. The dimensional tolerances for rods, tubes, and strips are approximately +/- 6%, and for plates are +/- 2%. All length tolerances are +/- 2%. The camber tolerance is 0.11 per inch. (dimensional graphics and tables)

Part numbering: Insert ( ) for material desired and insert ( \_ \_ \_ ) for length desired when ordering. All dimensions are in inches.

**ANTENNA PLATES**

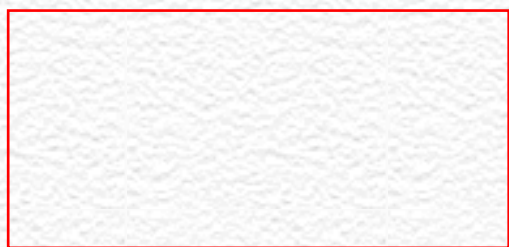

figure 1

<i>Part No.</i>	<i>Fig.</i>	<i>A</i>	<i>B</i>	<i>C</i>
AP( )-1070	1	2.187	1.437	0.187
AP( )-1049-1	1	3.500	3.500	0.250
AP( )-996	1	4.500	4.500	0.250
AP( )-1053	1	5.500	2.750	0.375
AP( )-1051	1	5.500	5.500	0.500
AP( )-1052-2	1	13.000	2.125	0.250

**ANTENNA RODS**



figure 2

<i>Part No.</i>	<i>Fig.</i>	<i>A</i>	<i>B</i>	<i>C</i>
R( )-125-( _ _ _ )	2	0.125		7.500
R( )-187-( _ _ _ )	2	0.187		7.500
R( )-250-( _ _ _ )	2	0.250		7.500
R( )-312-( _ _ _ )	2	0.312		7.500
R( )-330-( _ _ _ )	2	0.330		7.500
R( )-375-( _ _ _ )	2	0.375		7.500
R( )-500-( _ _ _ )	2	0.500		7.500
R( )-625-( _ _ _ )	2	0.625		7.500
R( )-750-( _ _ _ )	2	0.750		7.500
R( )-850-( _ _ _ )	2	0.875		7.500
R( )-1000-( _ _ _ )	2	1.00		7.500

**ANTENNA TUBES**



figure 3

<i>Part No.</i>	<i>Fig.</i>	<i>A</i>	<i>B</i>	<i>C</i>
AT( )-218-( _ _ _ )	3	0.218	0.063	7.500
AT( )-250-( _ _ _ )	3	0.250	0.125	7.500
AT( )-375-( _ _ _ )	3	0.375	0.125	7.500
AT( )-500-( _ _ _ )	3	0.500	0.250	7.500
AT( )-750-( _ _ _ )	3	0.750	0.375	7.500
AT( )-875-( _ _ _ )	3	.0875	.0431	7.500
AT( )-1000-( _ _ _ )	3	1.000	0.500	7.500
AT( )-1250-( _ _ _ )	3	1.250	0.500	7.500

**ANTENNA STRIPS**

<i>Part No.</i>	<i>Fig.</i>	<i>A</i>	<i>B</i>	<i>C</i>
-----------------	-------------	----------	----------	----------



figure 4

AS( )-350-( _ _ )	4	0.350	0.200	7.500
AS( )-480-( _ _ )	4	0.480	0.125	7.500
AS( )-725-( _ _ )	4	0.725	0.125	7.500
AS( )-780-( _ _ )	4	0.780	0.165	7.500
AS( )-1000-( _ _ )	4	1.000	0.090	7.500
AS( )-1000-( _ _ )	4	1.000	0.375	7.500
AS( )-1250-( _ _ )	4	1.250	0.250	7.500
AS( )-1375-( _ _ )	4	1.375	0.250	7.500



1510 E Edinger Ave #B Santa Ana CA 92705

**800-679-3184**

---

© 1996 - 2002 **CWS ByteMark**  
All Rights Reserved

*Last Updated undefined*  
*CWS ByteMark is no longer affiliated with AMI or its associates.*

## High-Gain Preamp

By Lyle Koehler, KØLR

An on-line version of my [Universal Antenna Preamp](#) article, which first appeared in the August 1995 LOWDOWN, is available in the File Libraries section of the Longwave Home Page. This preamp will work with short whips, parallel-tuned loops, and various forms of coax-fed wire antennas. There are other "bells and whistles" including options for remote tuning and regeneration. All of these features are useful under some circumstances, but frankly I rarely use most of them, and a simpler circuit is usually adequate.

The circuit shown in the diagram below may be used with either parallel-tuned loops or with coax-fed wire antennas. With switch S1 in the "LOOP" position, the frequency range of the preamp is determined by the inductance of the loop and the capacitance range of variable capacitor C3. The diagram shows a range of 30-500 pF for C3. At one time, Mouser Electronics sold a compact 2-gang capacitor that was ideal for this circuit, but unfortunately they have discontinued the part. A single or dual 365-pF variable would be a good substitute. I recommend Reg Edward's RJLOOP3 software, available on the G4FGQ web page, for designing a loop that will work on the desired frequency range with whatever capacitor you have available. Although the preamp was designed for use on LF, it will deliver good performance well into the HF range with the proper loop antenna. It is important to keep the lead lengths short when using the "LOOP" position. For example, if the loop is connected to the preamp through 3 feet of 50-ohm coax, this puts a fixed capacitance of about 90 pF across the loop and will limit the upper end of the tuning range. Any reasonable length of almost any coax may be used between the preamp and the receiver.

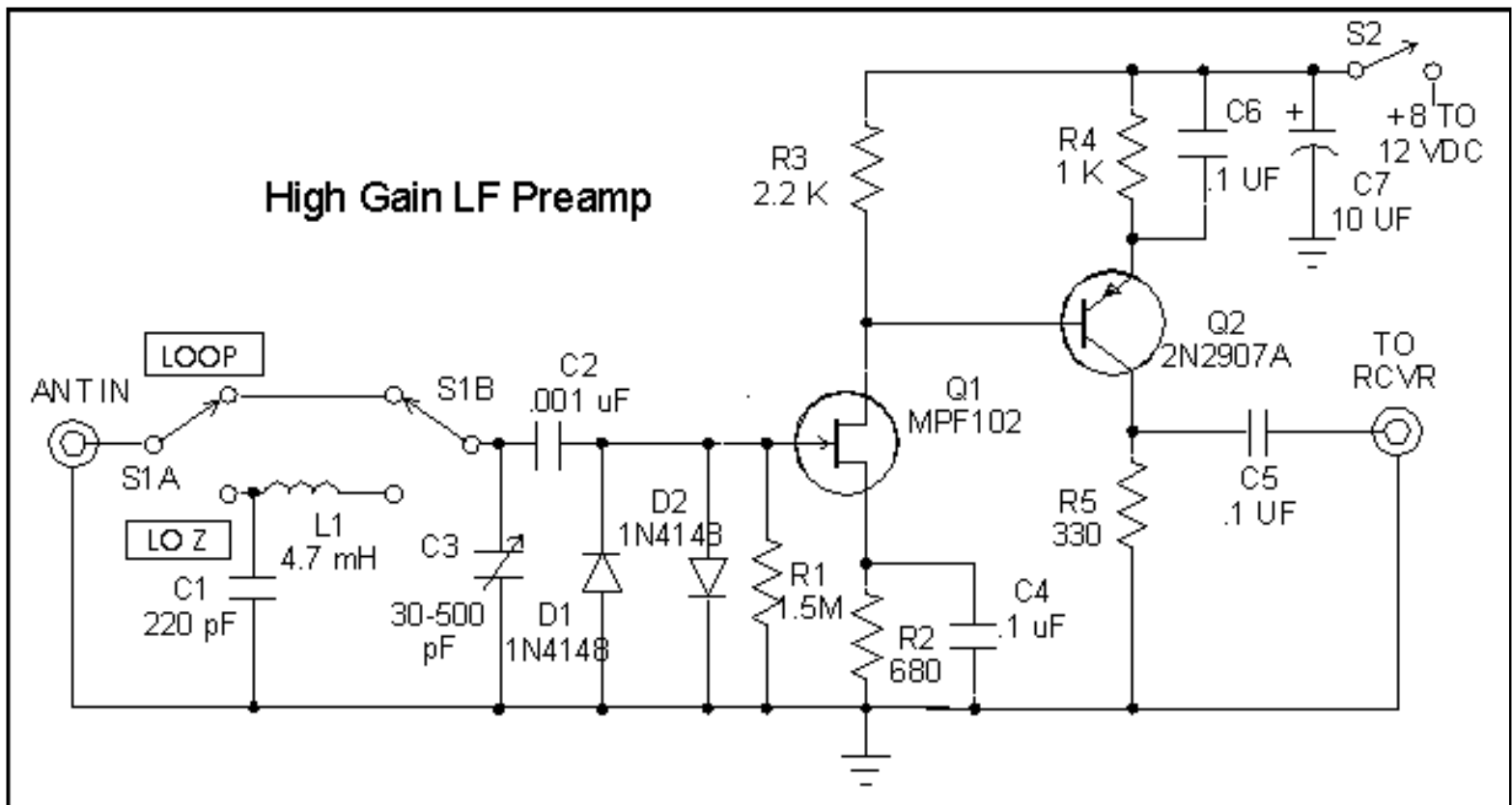

The "LO Z" or low-impedance position of S1 is used for coax-fed wire antennas. There is enough gain for use with fairly short whips such as the 5/8-wave 2-meter whip that I often use for mobile LF reception. When used with large antennas like an 80-meter or 160-meter dipole, it may be necessary to attenuate the input signal to prevent overloading. A 0.02 uF or larger capacitor connected across the input terminals will help to reduce overloading

from strong local broadcast stations. The recommended part for L1 is a Mouser Electronics 434-02-472J. Different values of L1 may be substituted for use on frequencies other than LF.

Diodes D1 and D2 are simply clamping diodes to protect the gate of the FET from high voltages that might appear on the antenna. They can be left out of the circuit if the preamp is to be used only with small loops, but they don't impair the performance and constitute a cheap "insurance policy". That is, if the diodes clamp the voltage before the FET blows out.

It helps to mount the antenna some distance from the shack, to get it away from noise sources like power supplies, computers, and the digital display in the receiver itself. When used with a parallel-tuned loop, which is how I do 99 per cent of my longwave listening, the preamp has to be located close to the loop and some form of remote tuning control is necessary. Those who are not as mechanically challenged as I am might find ways to do it with motor-driven air-variable capacitors. An easier solution is to use voltage-variable capacitance diodes (often referred to as "varicaps" or "varactors") in place of capacitor C3. In the diagram below, C3 has been replaced by two pairs of MVAM109 or MVAM108 diodes, which will give a capacitance range of about 40 to 500 pF. A loop with an inductance of 2 millihenries should tune from about 160 to 500 kHz. The tuning control potentiometer R9 can be in the shack, with a two-conductor shielded cable carrying the power and tuning voltage to the remote preamp. A separate coax is used to carry the signal from the preamp to the receiver. My "universal preamp" article shows how to run power, signal and tuning voltages through a single coaxial cable. However, it's often easier just to run separate wires. It is not necessary to use an extremely well regulated power supply, although the maximum voltage applied to the tuning diodes should not be much higher than 9 volts (only 8 volts is required to get the full tuning range with the MVAM108). The + side of the diodes, as indicated in the sketch showing the pinouts, goes to the common connection point of the diodes, where the tuning voltage is applied.

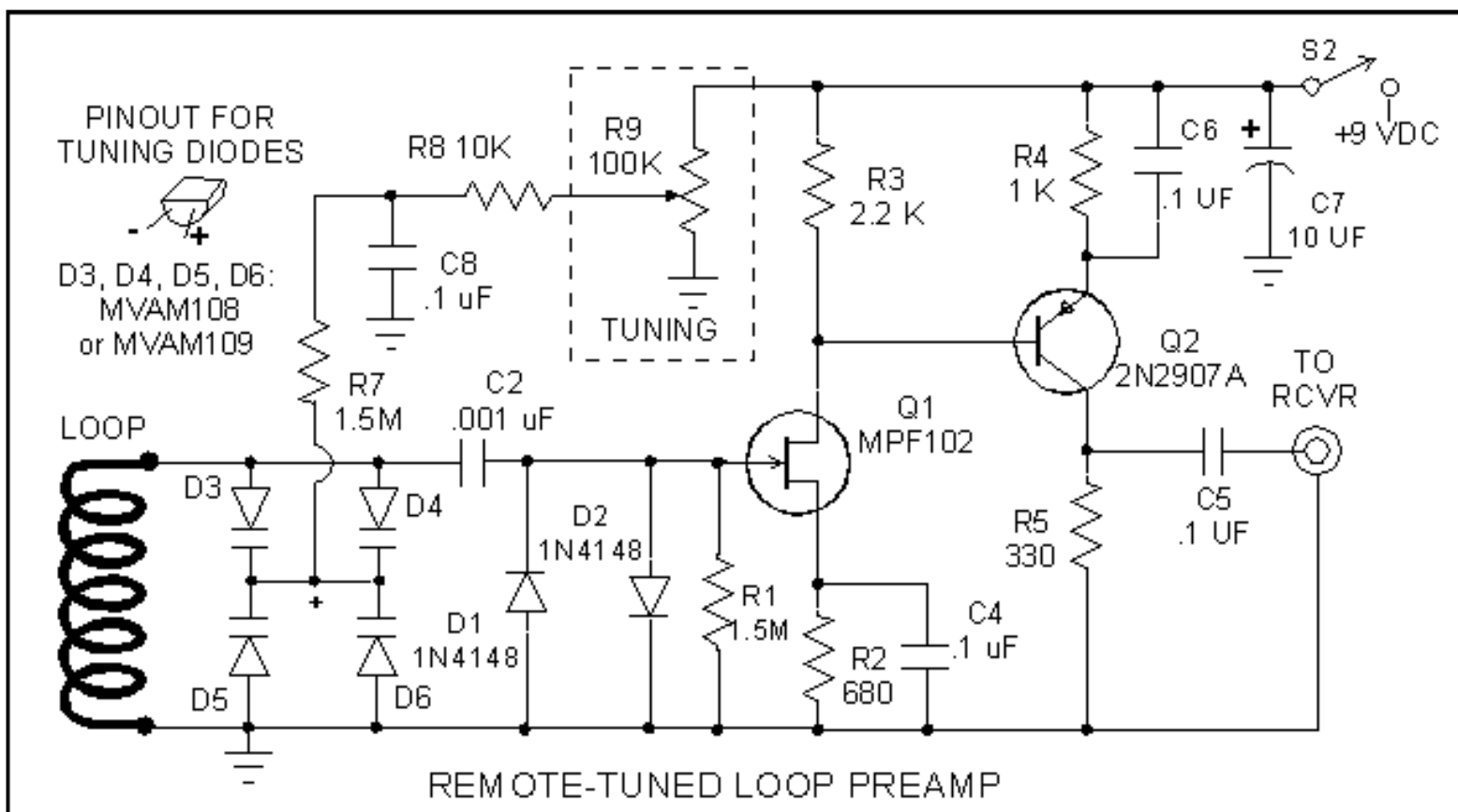

A note about tuning diodes: Most of them have a maximum capacitance of less than 100 pF, and need a wide

voltage swing to go from the maximum capacitance condition (at zero bias) to minimum capacitance. However, there is a series of "hyper-abrupt junction diodes" that were designed for use in electronically-tuned AM radios. The Motorola MVAM109 will tune from about 500 pF with 1 volt of reverse bias to about 40 pF with 9 volts reverse bias. Since the resonant frequency of the loop/capacitor combination is proportional to  $1/C$ , a capacitance range of 10 to 1 will provide a tuning range of about 3 to 1 in frequency (limited at the high-frequency end by the internal parallel capacitance of the loop or inductor L1 in the preamp circuit). The MVAM108 has about the same capacitance change as the MVAM109, and requires a bias voltage range of only 1 to 8 volts. Not all of the parts suppliers that cater to experimenters carry tuning diodes, but Dan's Small Parts has them in his [on-line catalog](#). Tuning diodes are also available from DC Electronics (1-800-467-7736) and Tech America (1-800-877-0072).

SELECT:

[Home](#)

LINKS:

[Random  
Wire versus  
Magnetic  
Loop Test](#)[My  
Magnetic  
Loop  
Antenna  
\(Tx\)](#)Comments,  
suggestions  
or  
questions?  
[Drop me  
an email!](#)

## A Magnetic Loop Antenna for Shortwave Listening (SWL)

Now that we're on the downward slope of sunspot cycle 23 you may have noticed that some of your favorite broadcast stations don't come in as strong as they did a few years ago. This is especially apparent on weaker DX stations. The whip on your shortwave receiver used to be sufficient to pull in some good DX, but now you find yourself looking for something better.

Maybe you have been thinking, or even have already tried, putting up a wire antenna. This may be a great solution if you live in a reasonably quiet area, noise wise, and your shortwave receiver doesn't easily overload in the presence of strong signals. Perhaps you live in an apartment or are situated where installing a wire antenna is simply not feasible. Or maybe you're looking for something that offers a bit more mobility so you can take it into different rooms of your house. Consider the small single turn magnetic loop antenna if any of the above situations apply to you.

### Small Single Turn Magnetic Loop

The small single turn magnetic loop (SSTML) antenna consists of a single winding inductor, about 3 feet (1 meter) in diameter, and a tuning capacitor. A second loop, which is one fifth of the diameter of the large loop, is connected to the feedline and this small loop is positioned in the large loop on the opposite side of the tuning capacitor.

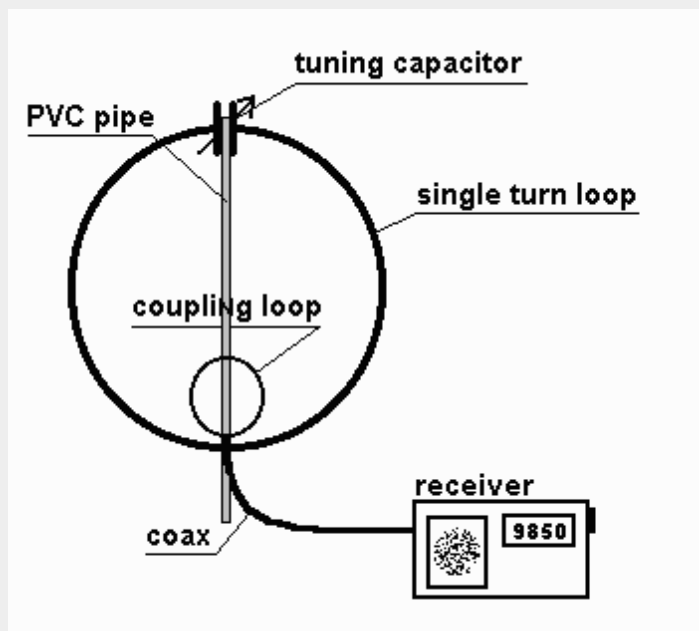

The SSTML has some very interesting properties:

- It has a small footprint. The loop I describe here looks like a circle in the vertical plane and is just a little over 3 feet (1 meter) in diameter.
- It is a rather quiet antenna. It doesn't pick up as much man-made noise from nearby sources as a wire antenna would in the same situation.



- c) This antenna is somewhat directional, which can benefit you in two ways. You can either aim (rotate) the antenna for maximum signal strength, or for minimum noise pickup. I prefer to do the latter, and here's why. This antenna has what is called a deep null on each side of the antenna, the broad sides, meaning that signals coming from that direction will be attenuated quite a bit (30 dB is an often-quoted figure). However, this is mostly true for signals we receive directly, like noise sources, and not so much for signals from broadcast stations coming to us through skywave propagation. I aim the antenna for minimum noise pickup, which results in the best signal to noise ratio. In some situations it is quite possible to fully tune out a noise source such as a TV or computer monitor.
- d) Since this antenna is really a tuned circuit, it also acts as a preselector. It only receives well in a narrow bandwidth of a few hundred kilohertz (kHz). The antenna requires retuning if you change the frequency on the radio by a hundred to two hundred kHz. This may sound like a disadvantage, but if you have ever tried a long wire antenna on a rather sensitive receiver, you probably have noticed that your receiver may get overloaded, resulting in hearing multiple stations at once or hearing broadcast stations on frequencies where there really aren't any. This may make it impossible for you to pull in that DX station you're really interested in or even make listening to a strong broadcast station rather unpleasant. This antenna will help prevent overloading your receiver.

When you search the World Wide Web for magnetic loops, you usually run into magnetic loops meant for transmission in the upper ham bands, perhaps 14 MHz and above. To be able to transmit on these loops you'll have to follow stringent design rules in order to maximize the efficiency of the loop. If you're interested in a receive-only loop, then the design rules become very relaxed. There's no need for large diameter tubing and neither for a low loss capacitor to successfully build a loop antenna. On this page I will present a description of my SWL loop.

## **Main Loop**

I built the main loop of my SSTML from quarter-inch diameter soft copper tubing. This type of tubing is used to hook up an ice maker in a fridge to a water line. It's rather flexible and keeps its shape nicely after being formed into a circle. This kind of tubing comes in lengths of 10 feet in a bag, and you can find it at most hardware or appliance stores for about \$6. In fact all parts, except the tuning capacitor can be obtained from the hardware store. You can also use large diameter copper ground wire for the main loop. #6 will do just fine. However, this wire is rather heavy and not very flexible. I'll assume we use small diameter copper tubing.

Take the coiled tubing out of the bag and unroll it on a flat surface. A hardwood floor would be ideal. When you unroll the tube, try not to unroll it into a straight line. Instead, try to make a large circle while you unroll it. You'll see that this is rather easy to do. This will ensure that you get a nice circular shape that requires very little additional bending. This is more about aesthetics than performance, though.

To support the loop antenna, use a five foot schedule 40 (white) PVC pipe, with a three-quarter inch diameter. You can tie the loop on the pipe with some wire ties, but this will not be very sturdy. It is better to have the loop go through the PVC pipe. The top of the main loop where the ends come together can be mounted on piece of a bamboo skewer (purchased at the grocery store) that goes through the pipe. The bottom part of the loop goes all the way through the PVC pipe.

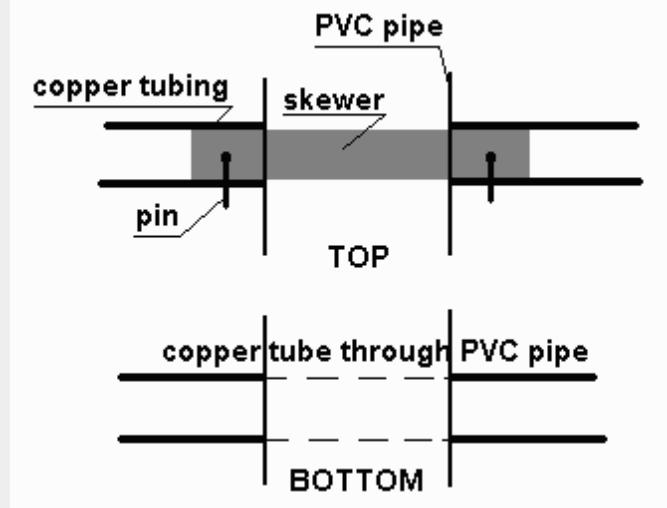

First make sure that the piece of skewer fits snugly in the copper pipe. Then drill a hole of the same diameter as the skewer near the top of the PVC pipe. Put the skewer in the hole so that about three quarter of an inch sticks out on both sides. Then lay the main loop on the PVC pipe so you can measure where the bottom hole goes. This hole should be the same diameter as the copper tube, and make sure you drill it in the same direction as the skewer. Now move the main loop through the bottom hole until the ends meet near the skewer at the top. Use the same motion as if you would put a key on a key ring. This will ensure that the loop maintains its shape. Then slide the ends of the main loop onto the skewer until the tube is flush against the PVC pipe on each side. Drill a small hole through the tube and the skewer. Next, form a pin from a small piece of solid #14 house wire, and slide it in the hole. Then bend the ends down on each side to prevent the pin from falling out. Do the same on the other side. Now the main loop is securely fastened to the PVC pipe and can still be taken apart if necessary.

## Tuning Capacitor

The tuning capacitor I used comes from an old alarm clock that had an AM/FM radio built in. You can find these at yard sales for a buck or two. Another excellent source are those five-dollar AM/FM mini boom boxes. I bought several of these radios at various chain stores and they all have a suitable tuning capacitor. The only thing you need to pay attention to is that the radio is indeed an AM/FM radio and not just an FM radio. These small radios are also a good source for parts for the homebrewer. You get a lot of parts for just \$5. The radio below is an example of such a mini boom box. The picture on the right shows you what the tuning capacitor looks like.



The tuning capacitors found in these radios consist of 4 separate variable capacitors (C1 through C4) and each of these capacitors has a trimmer parallel to it. There's also a convenient tuning wheel attached to the tuning capacitor. You'll need that also.

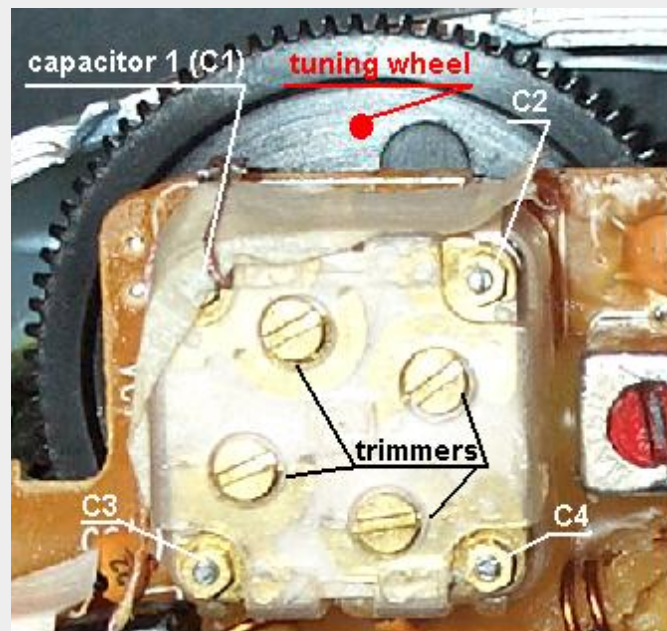

The tuning capacitor can easily be taken off the printed circuit board (PCB) by first removing the tuning knob and the two tiny screws that hold the capacitor to the PCB. Then you can desolder each of the six tabs and the capacitor is detached from the board.

Each of the tabs in the corner is attached to a separate capacitor, as marked in the picture above. Then there are one, two or three center tabs. If there is more than one, then these are all internally connected. You'll only need one of the center tabs, but don't cut off the ones you don't need. Just bend them so they're out of your way when you mount the capacitor, and make sure the unused tabs don't touch anything else.

One easy way to mount this capacitor is to first attach it to a mounting plate and then attach the mounting plate to the PVC pipe with some wire ties. The mounting plate can be made of any non-conducting material. I have used a rectangular piece of thin plastic from a picture frame, but you could also use a jewel case from your spouse's favorite CD as a source of thin plastic.

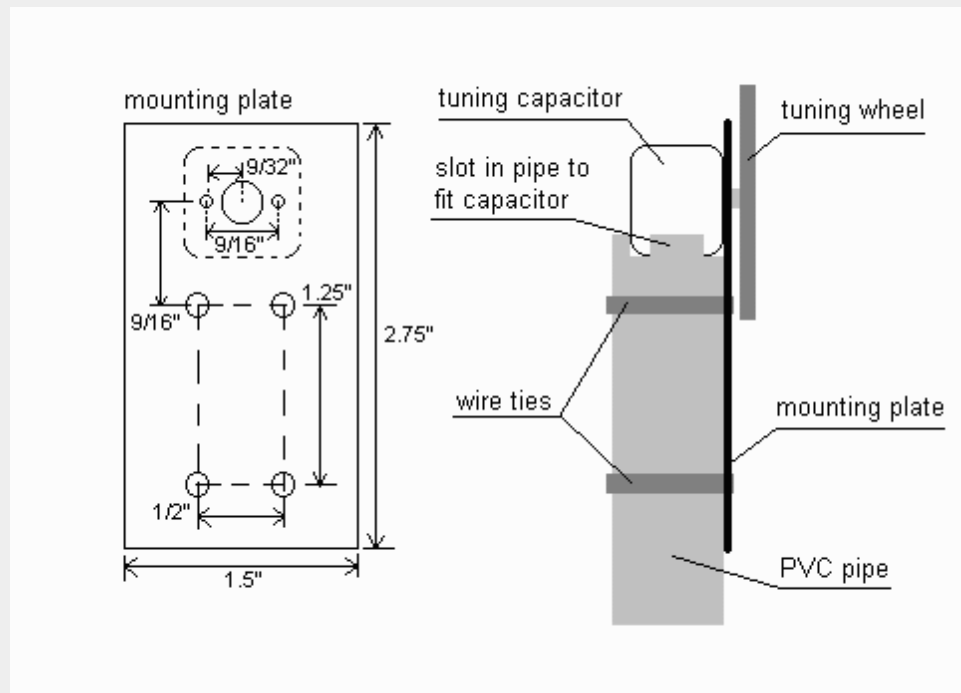

The measurements given in the drawing above are just guidelines. Actual dimensions and the sizes of the holes depend on the capacitor and the size of wire ties you intend to use. To prevent the mounting plate from sliding on the PVC pipe, cut or file a slot in the top of the PVC pipe into which the capacitor will have a snug fit. This will result in a secure mount for the tuning capacitor.

After mounting the tuning capacitor on the PVC pipe, you can go ahead and make the electrical connections. Solder the tabs of C1 through C4 together first. The tabs are probably long enough to do this. If not, use something like #14 wire, solder wick, or any other larger diameter wire. Make sure you do not connect any of the center tabs to this assembly. In the picture below you'll see that I have one unused tab. The reason for this will be explained in the Testing and Tuning section.

Initially, all 4 capacitors have to be connected. Next take a short piece of large diameter wire and solder it to the assembly. The other end of this wire needs to be soldered to one side of the main loop. I have used the braid from a piece of RG-8 coax cable to make the connections to the main loop, but almost anything will do. Then take another piece of large diameter wire and solder one end to the center tab, and the other end to the other side of the main loop.

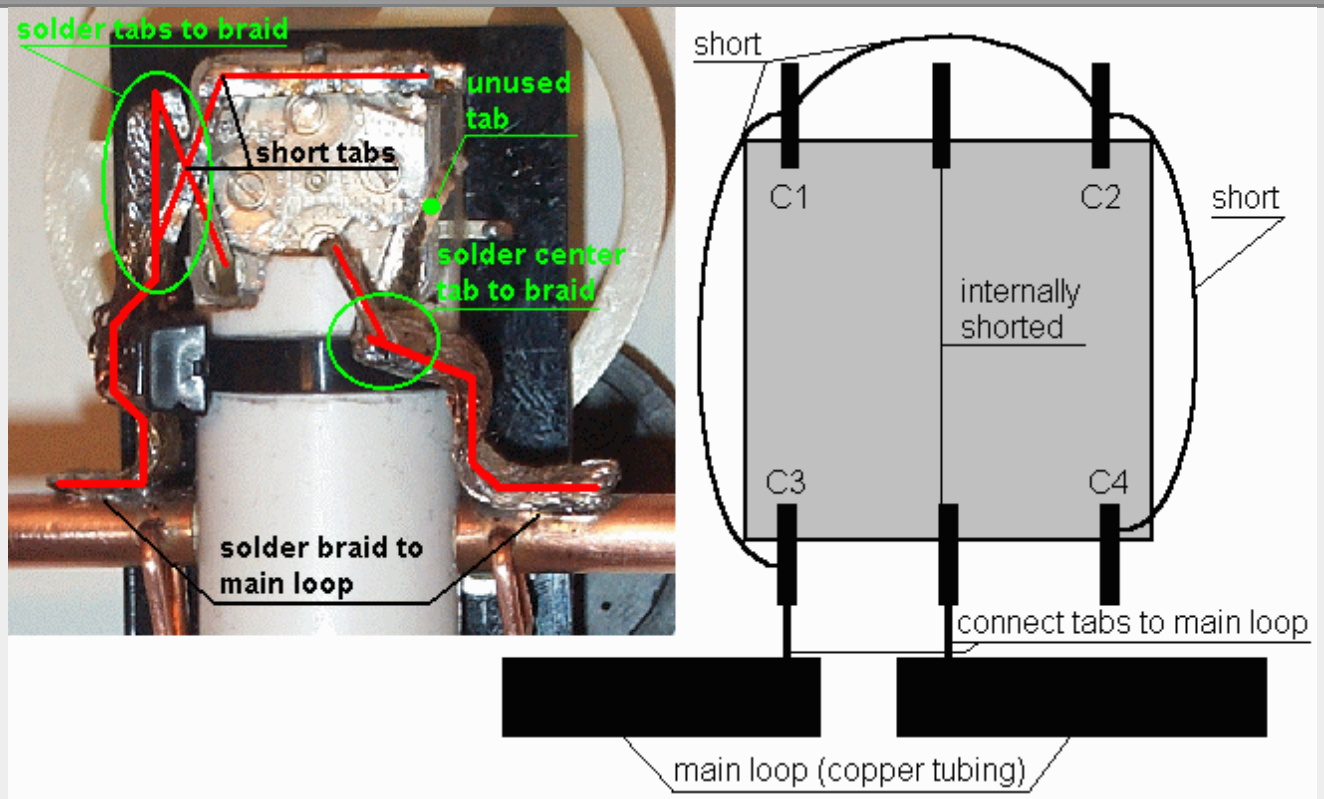

The main part of the SSTML is now finished. You can already test it by holding the whip antenna of your shortwave receiver very close to the upper half of the loop and tune the receiver to, say, 15 MHz. Rotate the tuning wheel clockwise until it doesn't go any further. Then slowly rotate the tuning wheel counter clockwise. At some point you will notice an increase in the noise coming from your receiver, and perhaps you'll even be able to hear the WWV station. There will definitely be a peak in the noise, and when you rotate the tuning wheel further, the noise will decrease again.

The next step is to build the coupling loop that will pick up the energy generated in the main loop and offer it to the receiver.

## Coupling Loop

When you look at the many designs of magnetic loops on the internet, or in various other publications, you'll notice that there are different ways to construct coupling loops. Some don't even use a loop, but a gamma match to connect the magnetic loop to the feedline. However, this would require another variable capacitor. Other designs use a coupling loop built from coax cable, and the center conductor and braid have to be connected in a certain way to minimize noise pickup. I've experimented quite a bit with different types of coupling loops, including complex ones built from 4 pieces of coax, but I noticed no difference in performance compared to the simple wire loop. So let's keep this simple.

I constructed the coupling loop from solid #14 house wire. The size of the wire is not critical at all; just pick a size of whatever you have laying around that will keep its shape once mounted on the PVC support pipe. The length of the wire should be about 2 feet if the circumference of the main loop is 10 feet. In other words the length of the wire for the coupling loop is one fifth of that of the main loop.

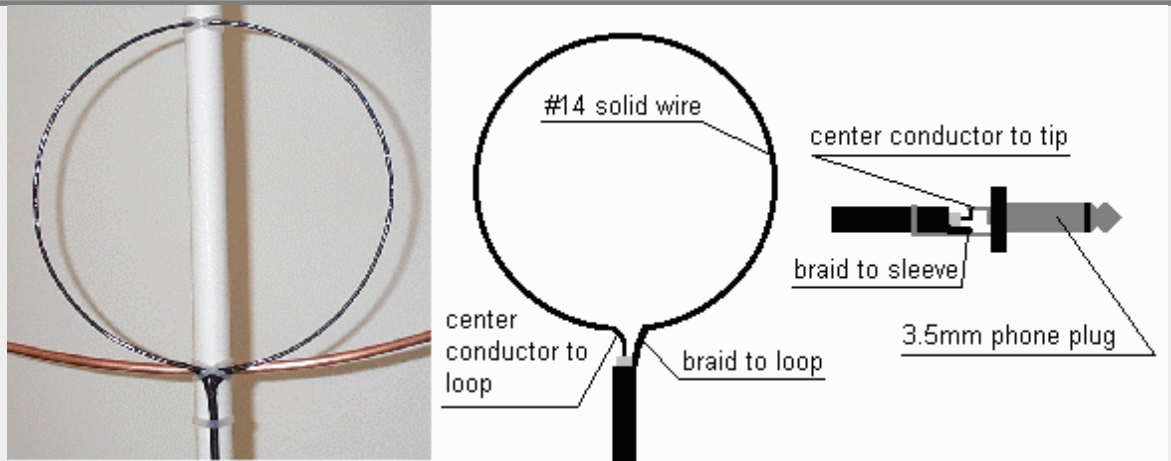

Bend the wire in the shape of a circle and solder one end to the center conductor of the feedline (coax) and the other end to the braid. Use some electrical tape or shrink tubing to cover the exposed parts. On the other end of the coax you can attach a connector that will fit into your receiver's external antenna jack. One of my favorite receivers, a Radioshack DX-398, uses a 3.5 mm phone jack that is easily obtainable at Radioshack. Solder the center conductor to the tip of the plug and the braid to the sleeve. Check the manual of your receiver to find out what the correct plug is and how the coax needs to be connected.

Once the coupling loop is completed you can attach it to the PVC support pipe with a few wire ties. The coupling loop needs to be mounted on the opposite side of the tuning capacitor, which is the bottom of the main loop.

## Feedline

The feedline of choice is coax for this antenna. This is mainly a choice of convenience, as you can route coax much more easily than balanced feedlines. Which type of coax, or the length, doesn't matter. You can use RG-58, but if you have only TV coax (RG-59, RG-6) available, then that will work just fine. Use whatever you have.

## Tripod

I built the tripod from 3 threaded rods, 9 nuts, and a short piece of one-inch schedule 40 PVC pipe. Drill three holes at the same angle through the PVC pipe, but at different heights. The rods have to overlap each other inside the pipe, so each successive hole has to be higher than the previous one (a little over 1 time the diameter of the rod).

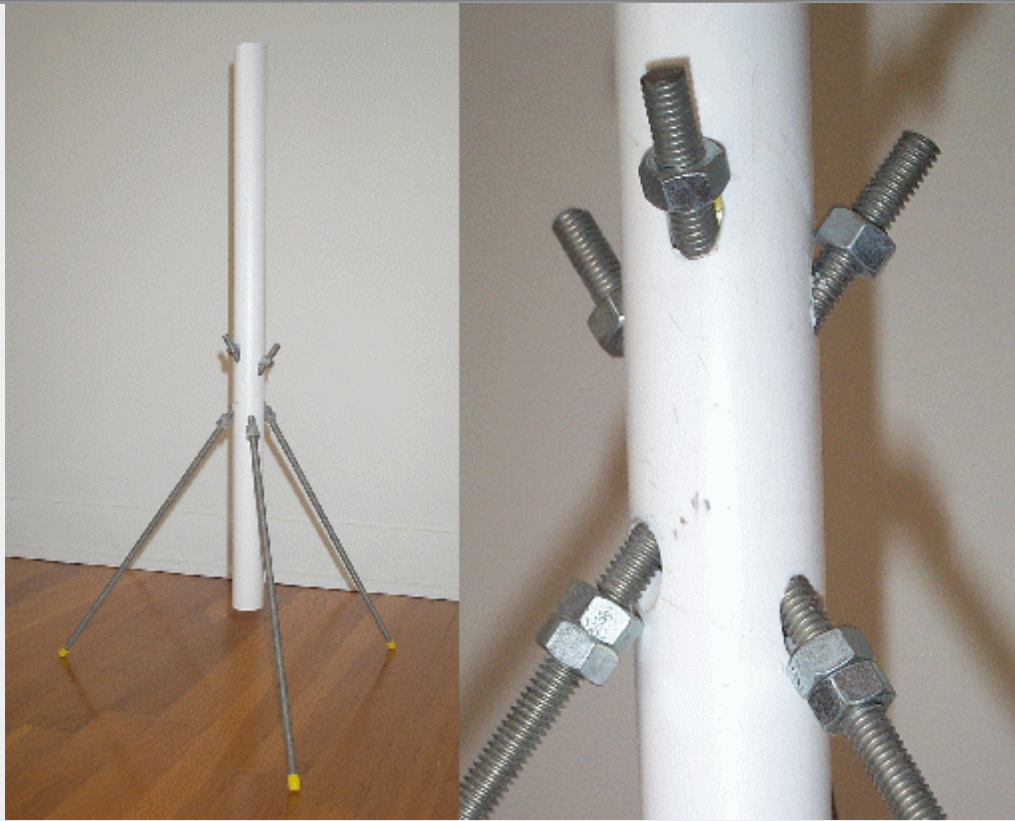

The yellow rubber caps can be found in the hardware section of the hardware store, probably in the same area where they store the threaded rods. Before inserting the PVC support pipe of the SSTML you can drop a rubber ball into the tripod. Though not absolutely necessary, the ball will act as a ball bearing, and will help make rotating the loop a bit smoother.

## **Testing**

Once you have completed the loop, it should look something like this:

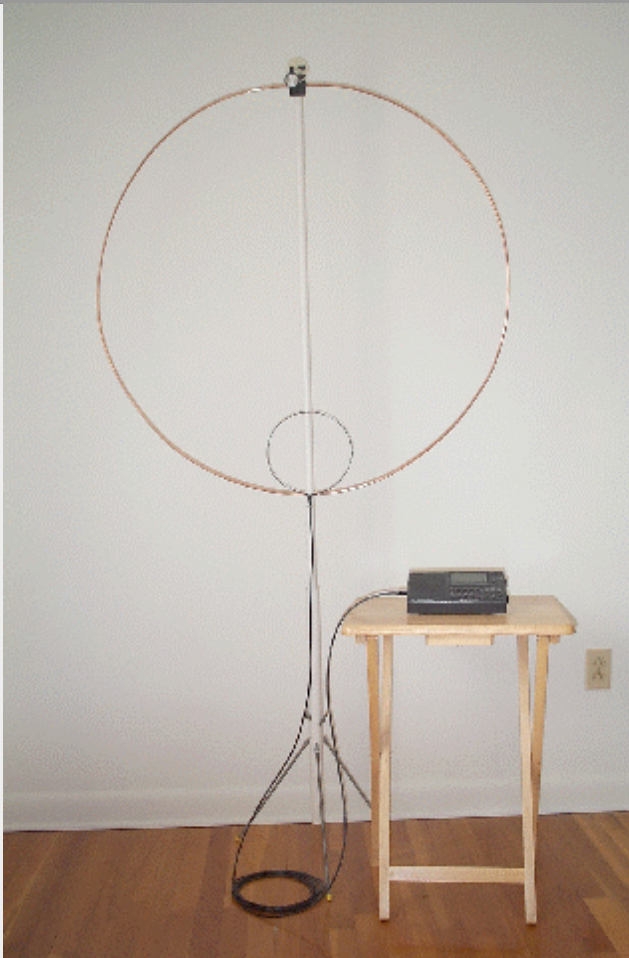

You can test the loop by connecting it to your receiver and trying to determine the upper and lower tuning limits.

First, make sure all trimmers on the tuning capacitor are open. Open means that the two halves (two half moon shaped pieces of metal) of the trimmer do not overlap. You can use a regular small screwdriver to do this.

To find the lower limit, connect a receiver to the loop and turn the tuning wheel/knob on the antenna fully counter clockwise. Turn the receiver on and tune it to 5 MHz. If you can select a step size on your receiver, select 5 kHz, and make sure the receiver is in the AM mode. In case the receiver has different filter settings, choose the widest filter available. Now tune the receiver up in frequency and listen to the noise level. At some point you will notice that the noise increases. Write down where you think the noise is at a maximum. On my loop that is around 5.3 MHz.

Now, to find the upper limit, tune the receiver to 25 MHz and turn the tuning wheel/knob on the loop fully clockwise. Tune the receiver down in frequency in 5 kHz steps and write down where you find the noise to be at a maximum. At 23.2 MHz I find the maximum noise on my loop.

You now know the tuning range of your loop. My loop tunes from the 49 meter band all the way up to the 13 meter broadcast band. This includes the 40, 30, 20, 17 and 15 meter amateur radio bands. Your loop may have somewhat different values for the lower and upper limits depending on the range of your tuning capacitor.

### **Fine Tuning (optional)**

The loop will probably cover all the shortwave bands you're interested in without any fine tuning. However, if you find that the loop does not cover a band you want near the upper or



lower tuning limit, it may be possible to add that band with some fine tuning. Keep in mind that if you raise the upper tuning limit, you will also raise the lower tuning limit and vice versa. Changing the tuning range of this loop antenna is like moving a sliding window over the shortwave bands.

If you'd like to raise the upper limit, you'll have to lower the minimum value of the variable tuning capacitor. This can be done by disconnecting one of the four capacitors. The trick is, of course, to find which capacitor needs to be disconnected. This has to be done by trial and error if no test equipment is available.

The tuning capacitor used here has two large capacitors and two small ones. One of the smaller capacitors needs to be disconnected. Since you don't know which one that is, simply disconnect one of the tabs of C1 through C4. Make sure the tuning wheel on the loop is rotated fully clockwise. Now tune the receiver to the previously found upper limit and then tune up in frequency. Note where you find the new maximum noise level. If you don't find this point, tune the receiver to 29990 kHz (upper limit of the shortwave band) and rotate the tuning wheel on the loop counter clockwise. If you find that you have to tune back the loop quite a bit, like 1/8 to 1/4 of a turn, then you probably disconnected a large capacitor. Reconnect the capacitor you just disconnected. Disconnect a different one and repeat the procedure described in this paragraph. If you now find that the upper limit has been raised by just a few MHz, then you know you disconnected a small one. Hopefully you'll now be able to tune the loop where you'd like it to tune. Remember though, that now the lower limit is raised also.

You can lower the lower limit somewhat by using the trimmers. First tune the receiver to the lower limit you found earlier. Now close one of the trimmers by rotating one of the screws 180 degrees with a screwdriver. This will add about 20pF (pico-Farad) to the total capacitor value. Not much, but it may be just enough. Since there are 4 trimmers, you can add 80pF in total. After you closed the first trimmer, tune the receiver down in frequency and find the new lower limit (tune for maximum noise). If that's not enough, close another trimmer and find the new lower limit. If that's still not enough, you can close the third and fourth trimmer. Hopefully that will bring the lower limit to where it needs to be. Keep in mind that the loop will probably not tune much lower than 5 MHz. Also remember that by lowering the lower limit you also lower the upper limit. This may mean that though you gain one band at the lower end, you may lose two or three bands at the upper end. You'll have to decide which is most beneficial to you. Since we're on the downward slope of the sunspot cycle, it may be more beneficial to lower the lower limit than raise the upper limit of the loop.

Of course you can try all kinds of combinations of closing trimmers and/or disconnecting capacitors. This will give you a wide variety of ranges, but can easily drive you crazy. Try to remember the sliding window principle. Adding capacity (i.e. closing the trimmers) will lower the lower and upper limits. Reducing capacity (i.e. disconnecting a capacitor) will raise the lower and upper limits.

## Results

So how good is this loop, anyway? Compared to the built-in whip antenna, it may very well be the difference between copying a signal comfortably or not hearing it at all. Consider the following recording:

### [Sample Recording \(1.4Mb\)](#)

This is a 12 second recording of a part of a conversation (QSO) between amateur radio operators in the 20 meter band (14 MHz.). The receiver is a DX-398 portable. The loop was positioned right next to the receiver. For the first 4 seconds I used the loop antenna. Then I switched to the whip antenna for the next 5 seconds, and then switched back to the loop. As you can hear, the difference is dramatic. The signal is virtually inaudible on the whip, but very clear on the loop.

You can see an example of how well it can reduce noise from nearby noise sources on my

[random wire vs. magnetic loop page](#). I compared a random wire antenna strung throughout an apartment to a magnetic loop antenna. Even though the loop used in that example was built also for transmitting, the results are the same when it comes to receiving. By pointing the broadside of the loop at an offending noise source, like a TV or computer monitor, the noise can be effectively reduced.

You may notice that due to the pre-selecting properties of the magnetic loop your receiver will be less likely to overload, especially compared to a random wire antenna. This will greatly enhance the enjoyment of shortwave listening on a sensitive receiver.

## **Conclusion**

It does take some time and effort to build this loop, but I'm confident you'll be pleased with the results. This loop took me about an afternoon to build, not including the tripod. Sure, stringing up a random wire antenna is a whole lot easier and quicker, but the results can be far less than desirable, especially in a noisy apartment setting.

It may sound somewhat complicated to build this antenna, especially the tuning section, but it really isn't. In fact you don't have to go through the tuning procedure at all. Chances are that even without fine tuning the antenna already covers all the bands you're interested in. It's a fun antenna to build and it gives you a greater sense of accomplishment than just stringing up a random wire. You're actually building an antenna.

I hope you'll enjoy your loop as much as I enjoy mine. Don't let the declining number of sunspots keep you from enjoying your favorite shortwave radio show.

© Copyright 2004. All rights reserved. Contact: [KR1ST](#)

# Sensitivity of Multi Turn Receiving Loops

William E. Payne, N4YWK

---

## ***Abstract***

Multi turn wire loops are often used as low frequency receiving antennas. Applications such as geophysical research, oil exploration and survivable communications require maximum sensitivity of receiving loop antennas. The loop sensitivity decreases as frequency decreases, becoming a formidable problem below 1 Hz. Basic electromagnetic theory is developed here as it relates to electrically small multi-turn loops at low frequencies. Simple algebraic expressions are produced describing the sensitivity of loops in simple geometries. The concept of antenna factor (effective aperture) is introduced, which allows comparison of different loops, and conversion of observations to common magnetic units of measure. It is hoped this work will be a useful reference to geophysical researchers, and to anyone designing loops for low frequencies.

## ***Introduction***

Magnetism is manifested as a 'field of vectors', that is, any point in the magnetic field has not only a magnitude, but a direction in space. The four Maxwell equations describe how electric and magnetic vector fields behave and interact. These "fields" are actually primordial root forces and motions of our spacetime continuum. It is well said that all the laws of physics can be derived from the Maxwell equations, given here in integral form:

$$(a) \quad \int_{\mathbf{c}} \mathbf{B} \cdot \mathbf{n} \, da = q_m = 0 \quad \text{No magnetic monopoles}$$

$$(b) \quad \int_{\mathbf{c}} \mathbf{D} \cdot \mathbf{n} \, da = q_e \quad \text{Sum of flux is electric charge.}$$

$$(c) \quad \int \mathbf{H} \times \mathbf{n} \, da = \frac{\partial}{\partial t} \mathbf{V} \quad \text{Curl of magnetic field due to electric flux change}$$

$$(d) \quad \int \mathbf{E} \times \mathbf{n} \, da = \frac{\partial}{\partial t} \mathbf{I} \quad \text{Curl of electric field due to magnetic flux change}$$

According to Maxwell, an electric field cannot change without creating a magnetic field, and a magnetic field cannot change without creating an electric field. Any change in one force field creates a vortex or wake in spacetime appearing as the other aspect of the force. Electromagnetic waves have both electric (E) and magnetic (H) components, and propagate as ripples in the fabric of our continuum. The E and H aspects appear 90 degrees apart in space dimensions and in phase in the time dimension. Loops of wire are often used as antennas to interact with and detect the magnetic aspect of the electromagnetic force.

Suppose we have a varying magnetic field 'out there' which we want to detect and measure. This field may originate naturally or artificially. To make the analysis more tractable, the loop is assumed to be electrically small, the dimensions being much smaller than a wavelength of the frequencies of interest. We also take the distance to the source as being much larger than the loop dimensions. These conditions are usually well satisfied in geophysics. We will use vector calculus to derive from first principles the response of such a loop. Those unfamiliar with this branch of mathematics may skip down to equation (10), where the going gets easier.

### ***Theory of Magnetic Loops***

Magnetic field intensity, H, expressed in units of amperes per meter, produces a magnetic flux density, B, expressed in volt seconds per square meter. Flux is proportional to applied field.

$$(1) \quad \mathbf{B} = \mu \mathbf{H}$$

$\mu$ , expressed in Henrys per meter, is the magnetic permeability of the medium, the analog of electric permittivity. We will let  $\mu$  equal  $\mu_0$ , the permeability of a vacuum (spacetime itself). This assumption is well justified for air core loops surrounded by non magnetic media, including air, water, dirt, vegetation,

etc.

The total magnetic flux,  $\Phi$ , in volt-seconds, threading an area is the flux density integrated over the area. The vector  $\mathbf{n}$  denotes a unit vector normal to  $da$ , the element of the surface being integrated over.

$$(2) \quad \Phi = \int \mathbf{B} \cdot \mathbf{n} \, da$$

Voltage around a loop is proportional to the rate of change of the amount of flux threading the loop area. When multiple turns are in series, the total voltage is the sum of the individual turns.

$$(3) \quad V = N \, d\Phi/dt$$

Notice from (3) that a motionless loop in a constant dc field produces no voltage. Combining these three equations gives an expression for the terminal voltage of a multiturn wire loop. The vector normal component of the H field is integrated over the loop area, and differentiated by time.

$$(4) \quad V = \mu_0 N \, d/dt \int \mathbf{H} \cdot \mathbf{n} \, da$$

When the H field is uniform over a planar loop, we can take H out of the integral and express its vector normal component as the magnitude times the cosine of the angle between the H vector and the loop axis.

$$(5) \quad V = \mu_0 N \cos\theta \, d/dt |\mathbf{H}| \int da$$

and the integral becomes simply the loop area.

$$(6) \quad V = \mu_0 N A \cos\theta \, d/dt |\mathbf{H}|$$

Most of the calculus is solved, but the time derivative of H remains. We can reduce it to simple algebra by examining a discrete frequency ( $\omega t$ ) component of H, with peak amplitude  $H_0$ .

$$(7) \quad \mathbf{H} = H_0 \sin(\omega t)$$

Which transforms equation (6) into:

$$(8) \quad V = \mu_0 N A \cos\theta \frac{d}{dt} (H_0 \sin(\omega t))$$

So we now rid ourselves entirely of calculus:

$$(9) \quad V = \mu_0 N A \cos\theta H_0 \omega \cos(\omega t)$$

Taking the magnitude of the signal, we get loop terminal voltage as a straight algebraic product of six terms;

$$(10) \quad V = 2\pi\mu_0 N A H_0 f \cos\theta$$

Where:

$2\pi\mu_0$	is a constant.
$N$	is the number of turns
$A$	is the loop area, in square meters.
$H_0$	is the applied magnetic field, in amperes per meter.
$f$	is the frequency, in Hertz.
$\cos\theta$	is the cosine of the angle between the loop axis and the field.

The persistent product of  $N$  and  $A$  are the only remaining terms which describe characteristics of the loop itself. This product suggests a figure of merit for loop antennas, the "effective aperture",  $A_e$ , which is the physical area times the number of turns.

We can now express the on-axis sensitivity of a loop, which is the terminal voltage divided by the applied magnetic field, as the product of only three terms:

$$(11) \quad V/H_0 = 2\pi\mu_0 f A_e$$

Where:

$V/H_0$	is the output voltage per unit magnetic field strength applied
$2\pi\mu_0$	is a constant = $7.89 \times 10^{-6}$ .
$A_e$	is the loop effective aperture, in square meters.
$f$	is the frequency, in Hertz.

Equation (11) clearly shows the problem of loops at low frequencies: as  $f$  approaches zero, so does the loop voltage! Although we can't do much to change  $2\pi$ , we might try increasing  $\mu$  above  $\mu_0$  by using a ferrite loop core, but this becomes impractical with large areas. Our only recourse is to increase the effective aperture.

### ***Effective Aperture***

We now have a rigorously derived expression for loop antenna sensitivity, reduced to the simple product of three terms, a constant, the frequency, and the effective aperture, which is the antenna factor. By knowing the effective aperture, we can relate the loop output back to the magnetic field strength. We can also compare the sensitivities of different loops, making possible the correlation of data from researchers using different loops. This effective aperture is simply the loop area times the number of turns, expressed in square meters.

The areas of some common loop geometries are:

**SQUARE**

$$A = k d^2 = d^2$$

$$k = 1$$

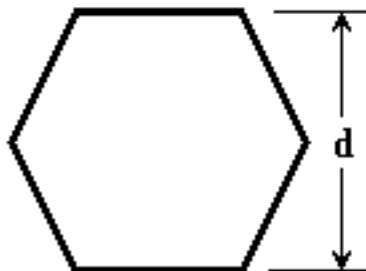
**HEXAGON**

$$A = k d^2 = .8660 d^2$$

$$k = \frac{3 \tan(30)}{2}$$

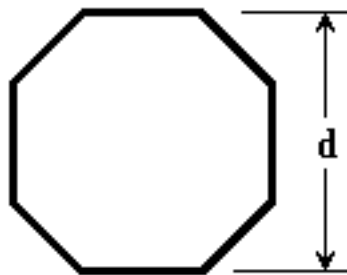
**OCTAGON**

$$A = k d^2 = .8284 d^2$$

$$k = \frac{2 + 2\sqrt{2}}{3 + 2\sqrt{2}}$$

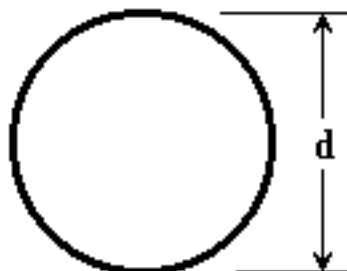
**CIRCLE**

$$A = k d^2 = .7854 d^2$$

$$k = \frac{\pi}{4}$$

**Maximizing Ae**

For maximum sensitivity, we want maximum effective aperture. Practical limitations dictate the effective aperture we can achieve. For example, we might be limited to 5lb loop mass of copper wire, and can handle wire as small as #30 AWG. What is the maximum effective aperture we can achieve?

From the NIST copper wire tables we get: wire diameter = 0.010 in, length = 16435 ft, and resistance = 526 ohms. For a circular loop, the wire length and loop area are:

$$(12) \quad N = \frac{l}{\pi d}$$



$$(13) \quad A = \frac{\pi}{4} d^2$$

So the antenna sensitivity for a fixed wire length is :

$$(14) \quad A_e = N A = \frac{l}{4} d$$

The  $d$  term appearing in the numerator tells us to deploy a fixed length of wire as a single turn for maximum sensitivity. The diameter will then be :

$$(15) \quad d = \frac{l}{\pi} = 5230 \text{ ft}$$

With an antenna factor of:

$$(16) \quad A_e = N A = A = 21,500,000 \text{ ft}^2 = 2,000,000 \text{ m}^2$$

A large effective aperture, but our trepidation in handling a one mile diameter loop of #30 AWG wire leads us to now limit the loop diameter to ten feet. Equations (12) through (14) give us:

the turns	$N = 523$
the area	$A = 78.5 \text{ ft}^2$
the aperture	$A_e = 41,100 \text{ ft}^2$ , or about $3800 \text{ m}^2$ .

This is a manageable structure, but sensitivity has been reduced 523 times.

Some rules of thumb for loop sensitivity are:

- **For a fixed number of turns:**  
Sensitivity goes up as loop diameter squared, and up as wire length squared.
- **For a fixed wire length:**  
Sensitivity goes up as the loop diameter, and down inversely as the number of turns.
- **For a fixed loop diameter:**  
Sensitivity goes up as number of turns, and up as wire length.

Which shows that "Turns are good, but size is better!" and "Use as much wire as you can!"

### ***Practical Examples And Considerations***

The 'octoloop' is an easily built, well shielded, VLF loop, small enough to gimbal, which was my primary design goal. The design files for the 'octoloop' are [available here](#), and on the LWCA BBS. The octoloop characteristics are:

$$\begin{array}{ll} A & = 3.42 \quad \text{m}^2 \\ N & = 50 \quad \text{turns} \\ Ae & = 171 \quad \text{m}^2 \end{array}$$

I also built a fixed loop of six pair telephone wire 160 feet in diameter in the backyard:

$$\begin{array}{ll} A & = 1865 \quad \text{m}^2 \\ N & = 12 \quad \text{turns} \\ Ae & = 22,381 \quad \text{m}^2 \end{array}$$

Obviously, the fixed loop is more sensitive, by a factor of about 130. In antenna terms, this is a gain increase of about 42 db, a substantial improvement! However, if by gimbaling the octoloop, I can get a 50 db deep null in interference, and stay above my receiver noise floor, the octoloop still has an 8 db advantage. On the other hand, with the fixed loop, if I filter out the power grid interference, I can go 130 times lower in frequency before falling below the thermal noise floor.

The octoloop is more useful for sferics and OMEGA reception, but the fixed loop is capable of deep infrasonic frequencies and geomagnetic work. Below some point in the spectrum, one must forego gimbaling and portability to gain very large antenna effective apertures. Larry Grant's "Life at 1200 Turns" loop probably has an aperture near  $Ae = 2000 \text{ m}^2$ , approaching the practical limit for portable loops. In oil exploration, loops of several hundred feet of multiconductor cable are transported by rolling them up on spools.

### ***Other Factors***

If an electric current flows in the loop, the terminal voltage and the sensitivity will be modified from that derived above. Current may be drawn by resistively loading the loop output, which will decrease the available voltage. Parasitic capacitance, as well as external capacitance will also cause a current flow, but one which is leading in phase. Capacitance neutralizes the lagging phase of the loop inductance and causes a frequency resonance, increasing the aperture while reducing the bandwidth. The magnitude of these tuning effects are maximum when loop resistance is minimum. Capacitively tuned loops are useful for their sensitivity to a single discrete frequency.

Mechanical motion of a conductor in a steady DC field induces a voltage, leading to microphonic effects. Microphonics may be reduced by structural stiffening and damping, to reduce vibrational resonances and shift them out of the frequency bands of interest. Many loop structures will have an axis of minimum vibrational response, which may be aligned with the local field to further reduce microphonics.

Temperature effects in dissimilar metallic junctions cause Seebeck voltages to be produced, which generally have time constants as long or longer than the thermal cycle. Temperature also causes voltage drift in high gain DC coupled amplifiers. Thermal effects may be controlled by isolating amplifiers and metallic junctions from temperature changes, by DC blocking, or by chopper stabilizing DC amplifiers.

### ***Direction of Future Work***

The fixed loop was originally intended for OMEGA (the 10 to 14 kHz squeal) reception, but Larry Grant and Bob Confrey have me interested in geomagnetics. Presently, I am working out an improved preamplifier design for geomagnetic frequencies. I am convinced the best way to go is a fixed moderate gain first stage at the loop, using a biomedical instrumentation amplifier such as Analog Devices AD620, and then put more gain with adjustments, filtering, etc in a separate indoor unit. For large aperture loops, the preamp must tolerate very high 60 Hz hum levels without desensing or intermodulation.

Also I am looking for yet more antenna aperture. Just today, I screeched my truck to a halt and leaped into a muddy excavation wearing my good pants because I believed I saw an abandoned length of 600 pair telephone trunk cable. The area of my backyard is about 6300 m<sup>2</sup>, which enclosed with 1200 turns (600 pair) would give  $A_e = 7,500,000 \text{ m}^2$ . This would be the most sensitive loop I know how to make here, having three times the aperture of the hypothetical one mile turn of wire discussed above, and should be useful to below 0.01 Hz.

A DC block below 0.001 Hz or so will be required to remove the Seebeck potentials from 1200 spliced joints, and the antenna may be buried to reduce microphonics. I am at a loss for a feasible method of removing seismic microphonics, which I believe will appear as the next envelope boundary, although seismic microphonics may in themselves be a worthwhile study.

### ***Conclusion***

The sensitivity of loop antennas at low frequencies has been mathematically derived, and expressed in practical terms. The concept of effective aperture, and how to maximize it has been presented. It is my heartfelt recommendation that researchers calculate and report the effective apertures of the loops they use, and refer their measurements to loop terminal voltage. In this way, all geomagnetic observations can be converted to a common unit of measure.

### ***Acknowledgements***

I would like to thank Bob Confrey for sparking my interest in geomagnetics, Larry Grant for his landmark practical design, and Anthony Fraser-Smith for his pioneering work. I also want to thank Dr. John Weaver, Dr. Walter Nunn, and L.A. (Kip) Turner for mentoring and inspiring me throughout the years.

*This article is protected under US and international copyright laws. Please obtain the author's permission before redistributing this document or reproducing it in any other form.*

---

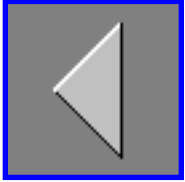

[Return to Receiving Equipment Library.](#)



[Go to Longwave Home Page.](#)

# Magnetic Loop Antenna's.

---

Why is an Magnetic Loop antenna so special, this antenna is picking only the MAGNETIC part of the ELEKTRO MAGNETIC radio wave. The big advantage of this antenna is that the electric interference from the big city (streetlights, television's , cars etc...) have no influence on the received signal. With the loop you can hear other stations that you can't hear if you use a DIPOLE, with a dipole the stations are buried in the noise.

---

## Multi Turn Magnetic Loop.

---

This is the first loop I build from a article in the QST from February 1996, it's 30 Inch-diameter, and it's designed by G2BZQ/WØ for 80 M.

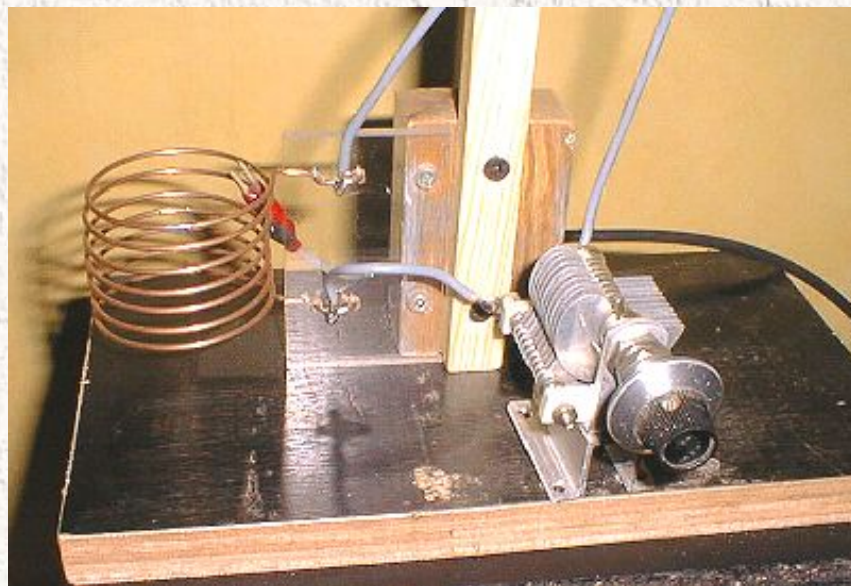
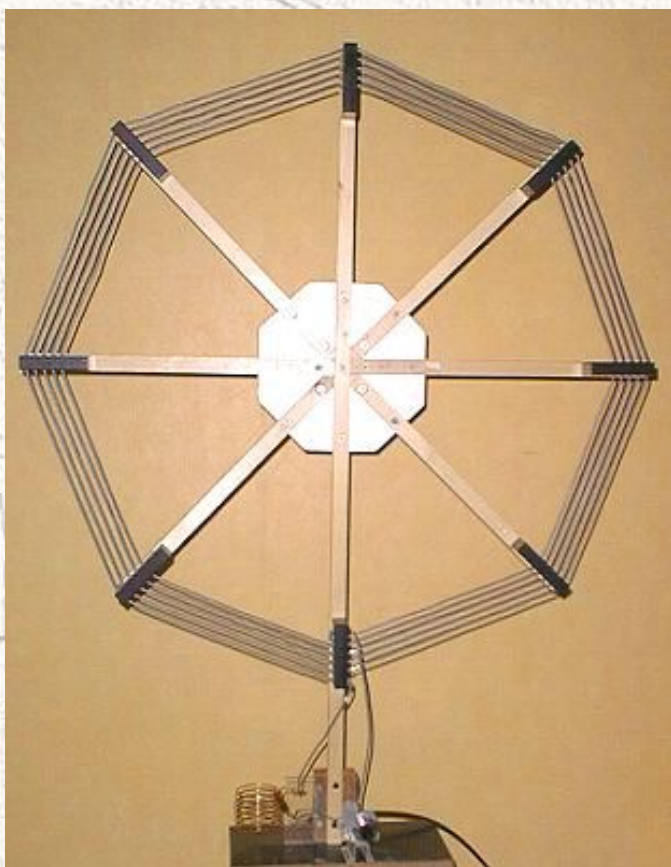

## Single Turn Magnetic loops

---

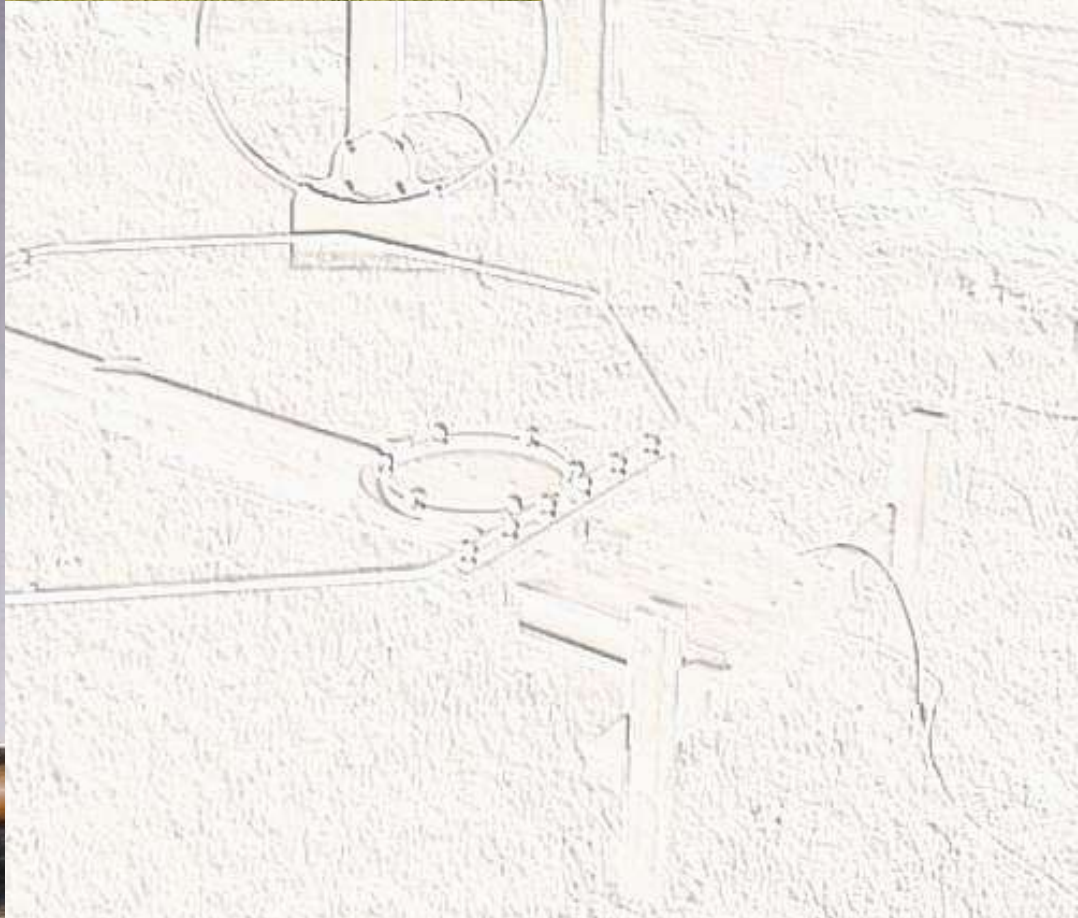

The first one turn loop that I built was made from 75 Ohm TV Coax and with a small explanation in the RSGB handbook for radio amateurs. I used the outer screen from the

coax and the results of the loop where good. The next loop I built is a octagon loop in 15mm copper tube with a circumference of 4.8 meter (16 feet).

The frequency range of this loop goes from 14 MHz to 7 MHz and works fine. The biggest problem is the tuning capacitor, if you transmit with a power of 100 W you need a capacitor with a voltage rating of 5000 Volt. A capacitor which can handle this voltage is hard to find over here and if you find one they are very expensive.

The first capacitor I built was a design from GW3JPT from a article in the RADIO COMMUNICATION from February 1994. It is a split stator capacitor with a capacitance of 140 pF and with a voltage rating of 6000 Volt.

The capacitor is remote tuned with the use of a small BBQ spit motor.

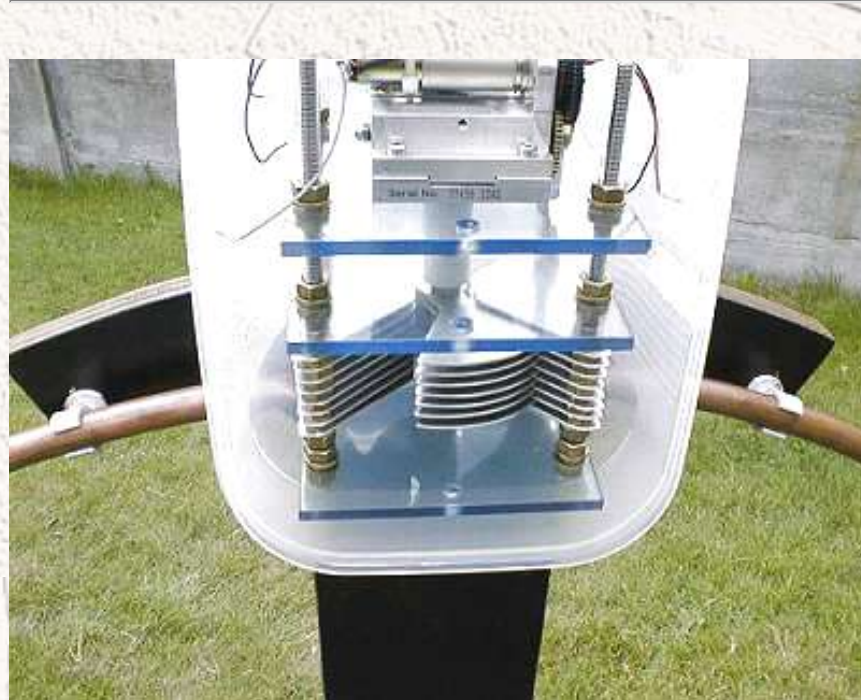

The second capacitor I built is my own design and it's a butterfly capacitor because the losses are lower than a split stator.

The capacitance is 5-65 pF and the voltage rating is 7200 volts. I used it for the small loop with a dia. of 800 mm (2.66 feet) and the frequency range of this loop is from 28 MHz to 14 MHz. The Aluminum plates of 1 mm for the capacitors are cut with a JIG SAW.

---

#### Most asked Questions:

I`d like to talk a little more on your setup. it seems like something which I could get together if only some more data was available. do you have any notes etc still laying about since its build ?

The theory for calculating the loop is very simple. The circumference of a magnetic loop is 1/4 wave of the design frequency.

Example for 14 MHz.

$$300 / 14 \text{ MHz} = 21.428 \text{ m is 1 wave}$$

$$21.428 / 4 = 5.357 \text{ m is 1/4 wave circumference}$$

$$5.357 / 3.14 = 1.706 \text{ m diameter.}$$

The recommendations are that you can tune the loop from the design frequency to the frequency divided by 2 to keep the efficiency acceptable.

$$14 \text{ MHz} / 2 = 7 \text{ MHz}$$

I made the small loop (800mm / 31.5 ") from soft copper tube on a role that you can buy in a plumbershop and it's easy to make a nice circle if you draw on the ground a circle with a rope and a piece of chalk.

For mounting the loop to the hardboard I used plastic clamps that they use for mounting copper tube on the wall.

### why is a butterfly capacitor better?

For high voltages and currents the use of Capacitors with wiper contacts is not recommended. That's why they use capacitors in serie's. The pro for serie's capacitors is that the voltage rating is doubled. The anti is that the value of capacitance is divided by 2.

For the split stator capacitor the 2 capacitors are connected in series by the shaft (bleu) and the red spots on the first drawing are losses.

For the butterfly capacitor the 2 capacitors are directly connected in series by the rotors and gives less losses.

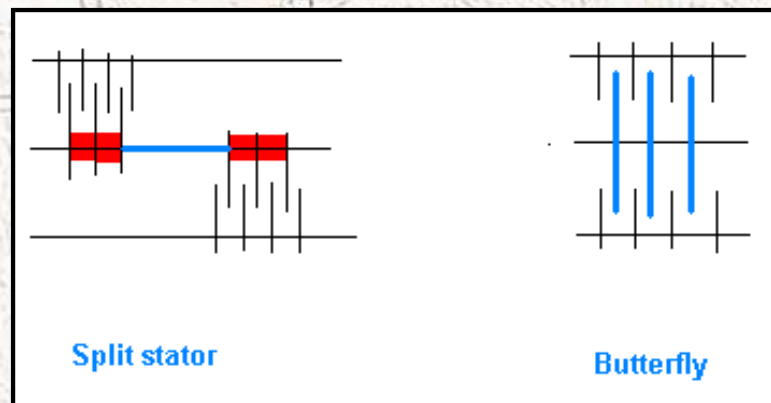

### Do you know of anyone that has built a similar loop that outperformed a garden variety dipole?

Compare antenna's is very difficult , sometimes I have for 60 % better signals in RX and TX on the loops then on the dipole.

In Theorie is the performance of a magnetic loop - 0.4 dB lower then a dipole or a vertical .



I have over here a homebrew trap dipole from 40-20-15-10m and the height aboveground is only 7 m(23 ft), for a good performance on 40 m the dipole must have a height of 1/2 wave above ground ( 66ft). I don't have a radiation angle on 40 m and it's only good for contacts in Europe and not good for DX, now the 1.5 m loop tuned to 7 MHz with a efficiency of 38 % (38 w ERP ) and a angle radiation of about 20 degrees performs better than the dipole because the vertical magnetic loop only 1 M above ground as a angle radiation and the dipole don't.

Another advantage is that the reception on a loop is mutch better, on 20m I have with the dipole S5 noise from the big city, if I switch to the loop I have S1 noise and hear stations who are buried in the noise when I use a dipole.

### Coupling loop dimensions?

I find that the best way to feed the loop is with the shielded 1/5 Faraday loop made from coax RG213 or RG8, I tried the gamma match bud I had problems to keep the VSWR low on all Bands, the shielded loop gives on all bands VSWR 1.1 and reduce more noise pick-up then the gamma match.

I found out that if you use a 1/5 Faraday loop, that the loop is to big, making the loop smaller with 0.5 inch by the time in circumference and checking with a field strength meter you can see that the radiated power increase.

The place off the feeding loop is placed at the electrically neutral point on the loop and that is 180° from the capacitor and I have the best results with the feeding loop close to the ground and the capacitor far from the ground.

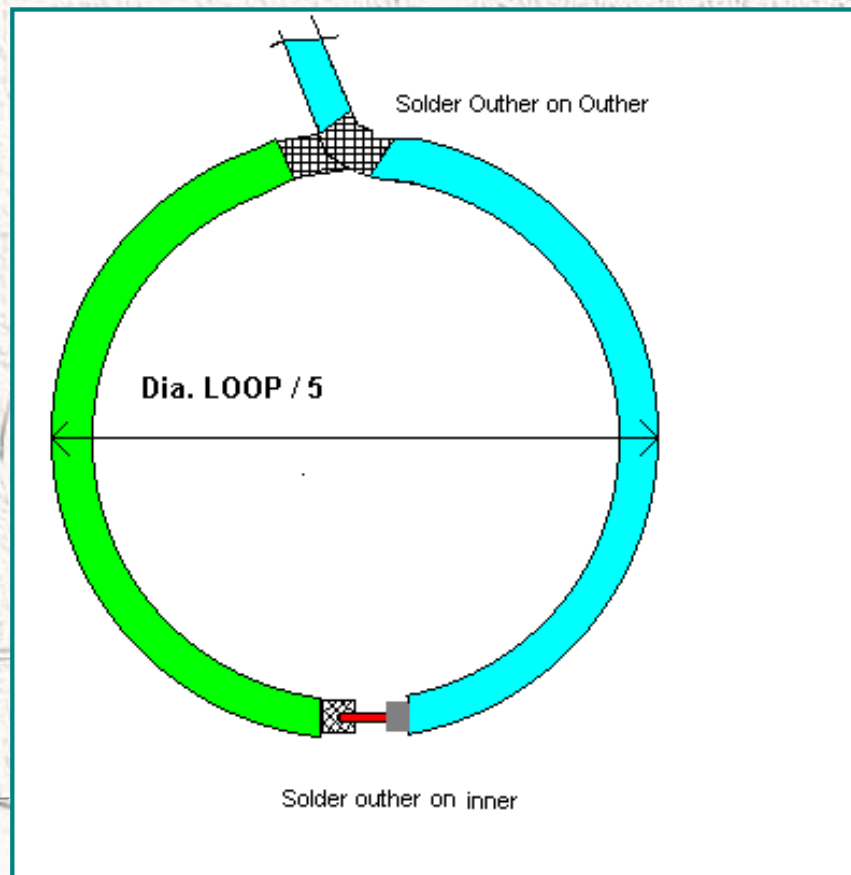

I was wondering if you worried about the resistance of the mechanical joints (copper pipe bolted to the capacitor) significantly reducing your radiation efficiency as I think the radiation of these antennas can get as low as .01 ohms

Soulder or weld the capacitor plates is always the best, but I'm afraid if you make the spacers and the plates in ALU that with welding everything is gona bend from the heat

and I know from practice ( I work in a maintenance workshop ) that welding ALU is coarse. Another possibility is using all brass or copper and solder, there are hams that using double PC board for the plates.

I made a QSO in phone with Florida, RPRT 5-5 and the other station used a vertical antenna, with the small loop (800mm and theoretical effieecency 41 % on 14 Mc) vertical in the garden and the states side is through the house. I was very happy with the results , so I think that a capacitor maded with torqued compressed joints is good enough for using 100 W.

---

Have the dissimilar metal joints weather well?

To keep the oxidation low on the dissimilar metals I used a thin coat of vaseline after assemble the capacitor and with the tupper ware a like plastic box it is good protect against all wheather conditions.

---

How to find the radiation angle of the antenna?

Can it be found practically?

Finding the radiaton of a magnetic loop is very easy, with a TL-lichtgt tube you can see it, with abt 10 w power on the the loop with the TL-tube in the plain of the loop at right angle to the circle you see the tube lightning, there where the the light is the farest on the tube thats the radiation angle.

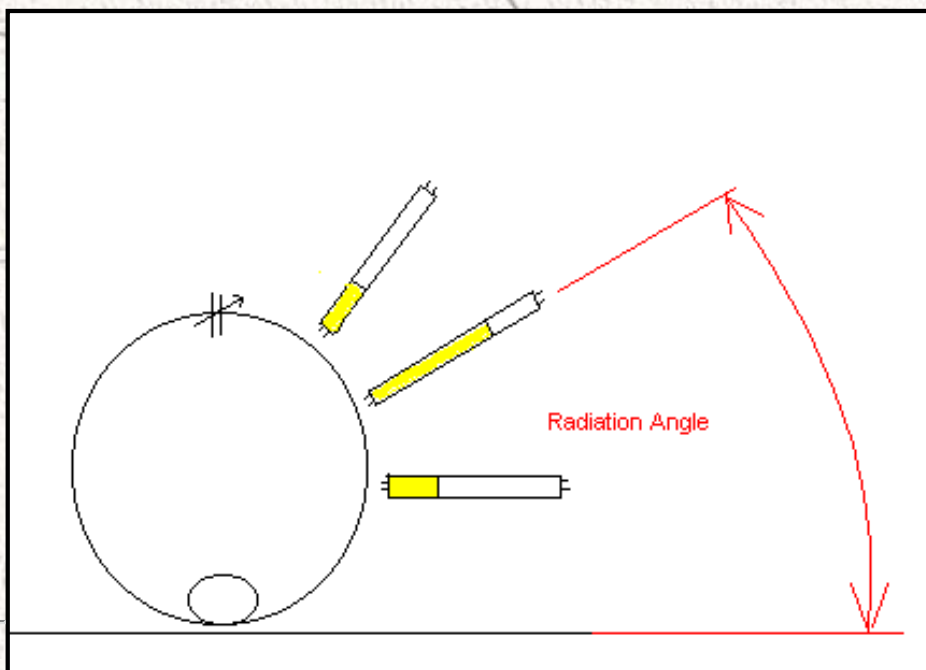

---

When you refer to washers, nuts and rods you use the term "M6".Please forgive my ignorance, but to what does "M6" refer? Does this mean 6mm?

M6 is (M=metrical) and 6 is indeed 6 mm threaded rod and you can compare the size with W1/4" (6.35mm) .

---

A very easy to build Piston Capacitor.

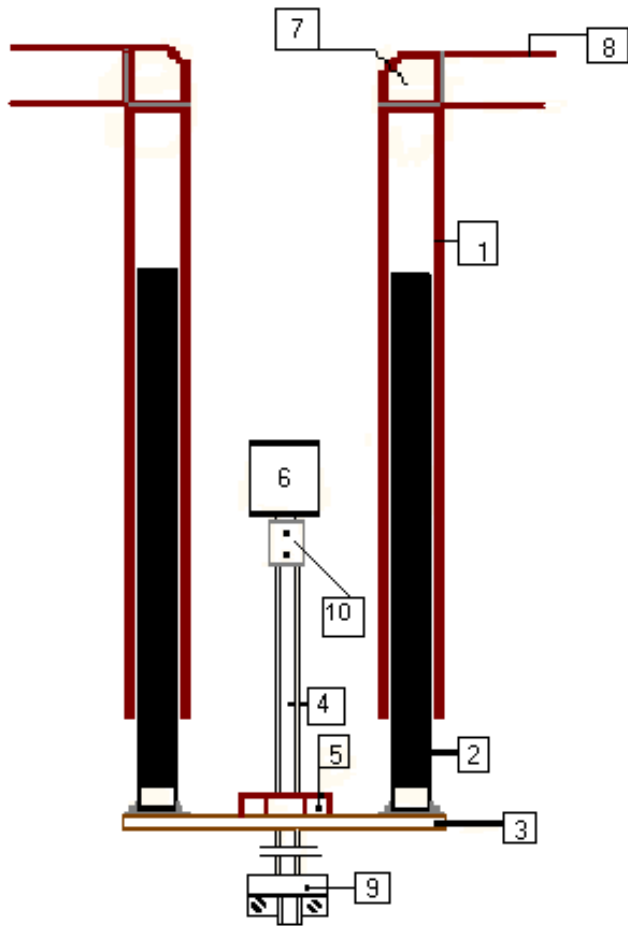

- 1) Copper tube
- 2) Coax RG8 or 213
- 3) Double PCB
- 4) Threaded Rod 1/4"
- 5) Brass nut
- 6) Motor with reduction or stepper motor
- 7) Copper Elbow 90°
- 8) Loop
- 9) Bushing from old var resitor
- 10) Couple shaft ( PVC)

[How to build your own Butterfly Capacitor.](#)

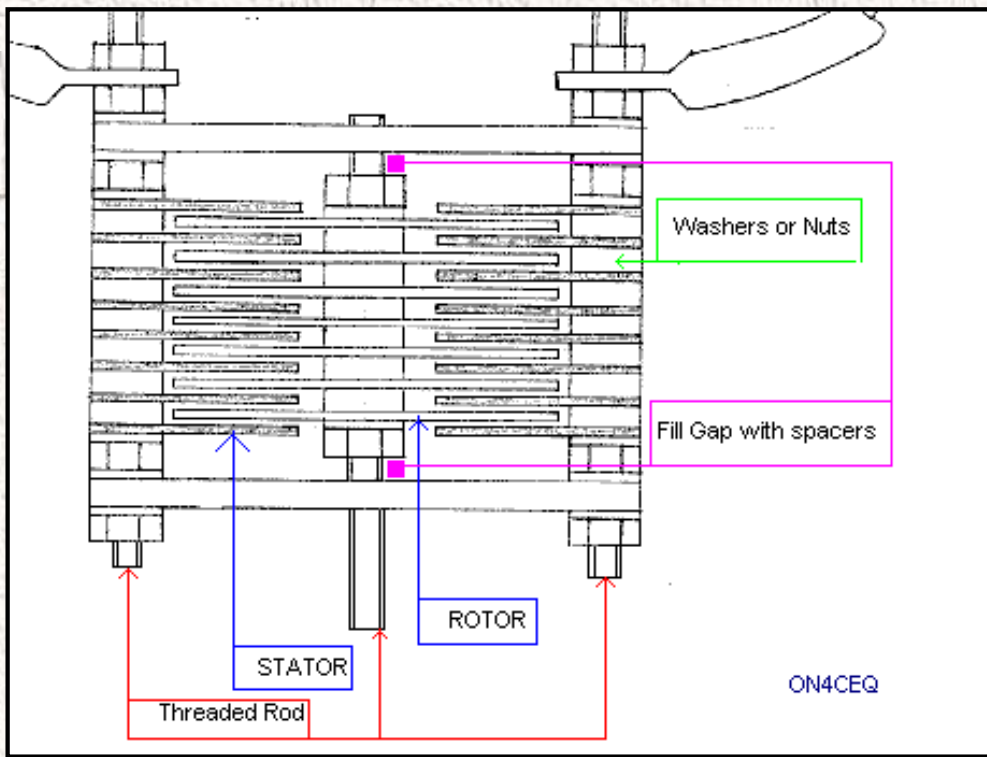

The best material for the front and the back is CLEAR PVC 3 or 5 mm thick as alternative you can use GREY PVC or 2 sheets pboard together with the copper removed .

The best material for the washers, nuts (M6) and threaded rod (M6) is brass or stainless steel,( NON MAGNETIC MATERIALS for the losses).

For the spacing of the vanes you can use 2 washers M6= ( 6Kv) or a nut M6 =( 12 Kv) if you use aluminum plate 1 mm thick.

If you use a nut then the best thing to do is remove the thread by drilling withØ 6.2 mm.

The effective area for the vanes is 11.7 cm<sup>2</sup> and with the formula

for 2 washers =  $(0.0885 \times 11.7 \text{ cm}^2) / 0.1 \text{ cm} = 10.35 \text{ pF}$  for 1 air gap.

for 1 nut =  $(0.0885 \times 11.7 \text{ cm}^2) / 0.2 \text{ cm} = 5.17 \text{ pF}$  for 1 air gap

Example:

If you you make a capacitor with 2 washers as spacing and you make 5 rotor vanes and 6 stator vanes then you have 10 air gaps.

$10.35 \text{ pF} \times 10 = 103 \text{ pF} + 10 \text{ pF}$  stray capacitance =  $113 \text{ pF} / 2 = 56 \text{ pF}$

The final result is a capacitor with a value from 5 - 56 pF.

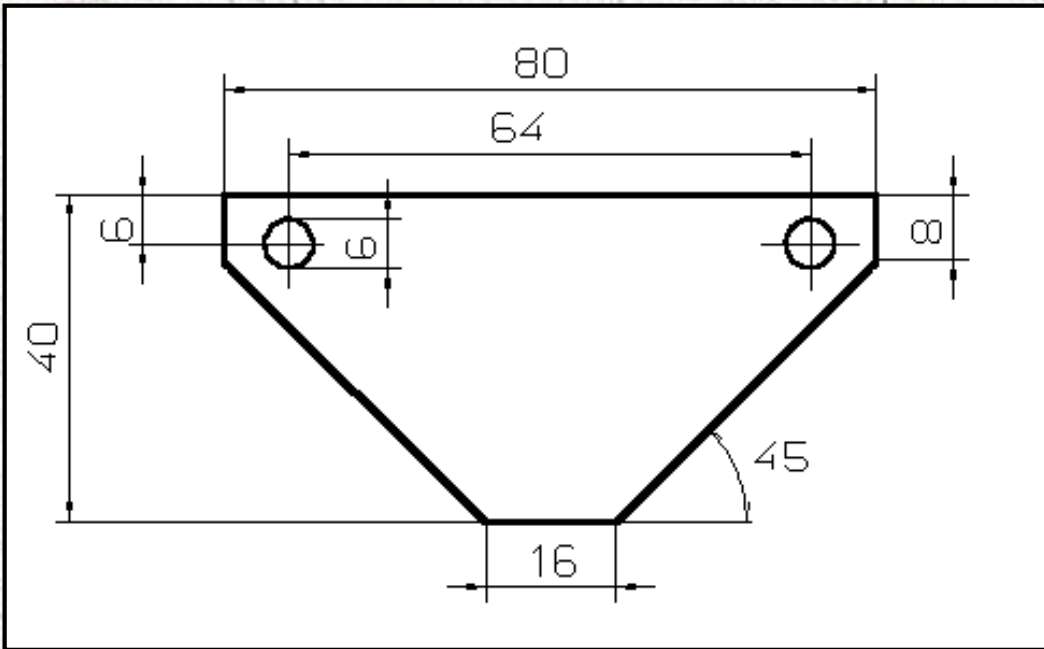
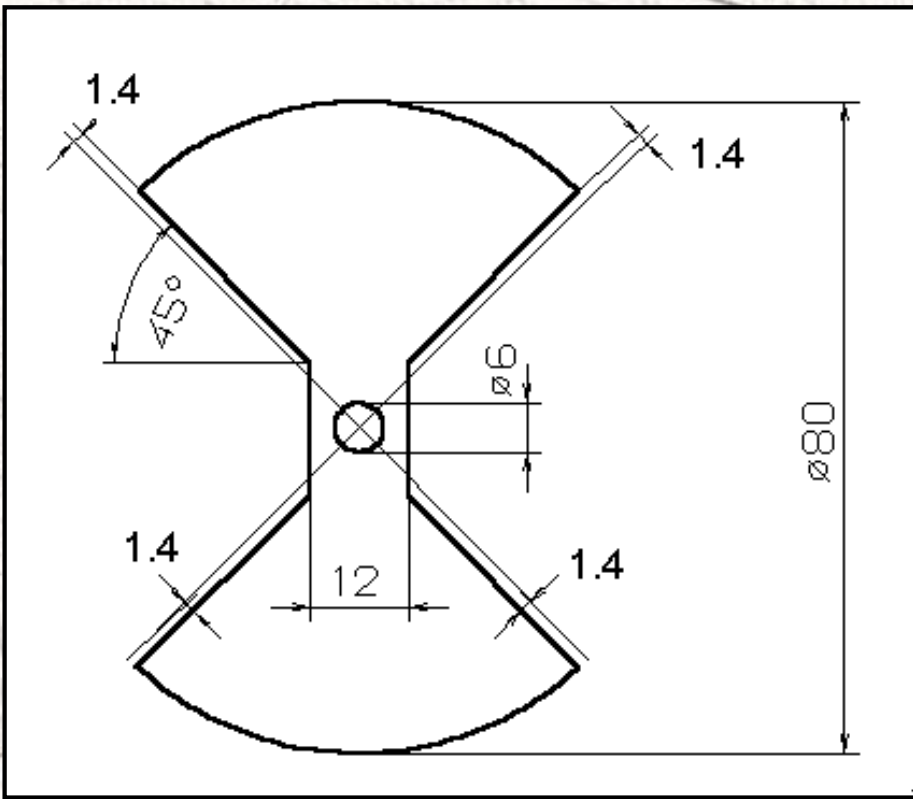

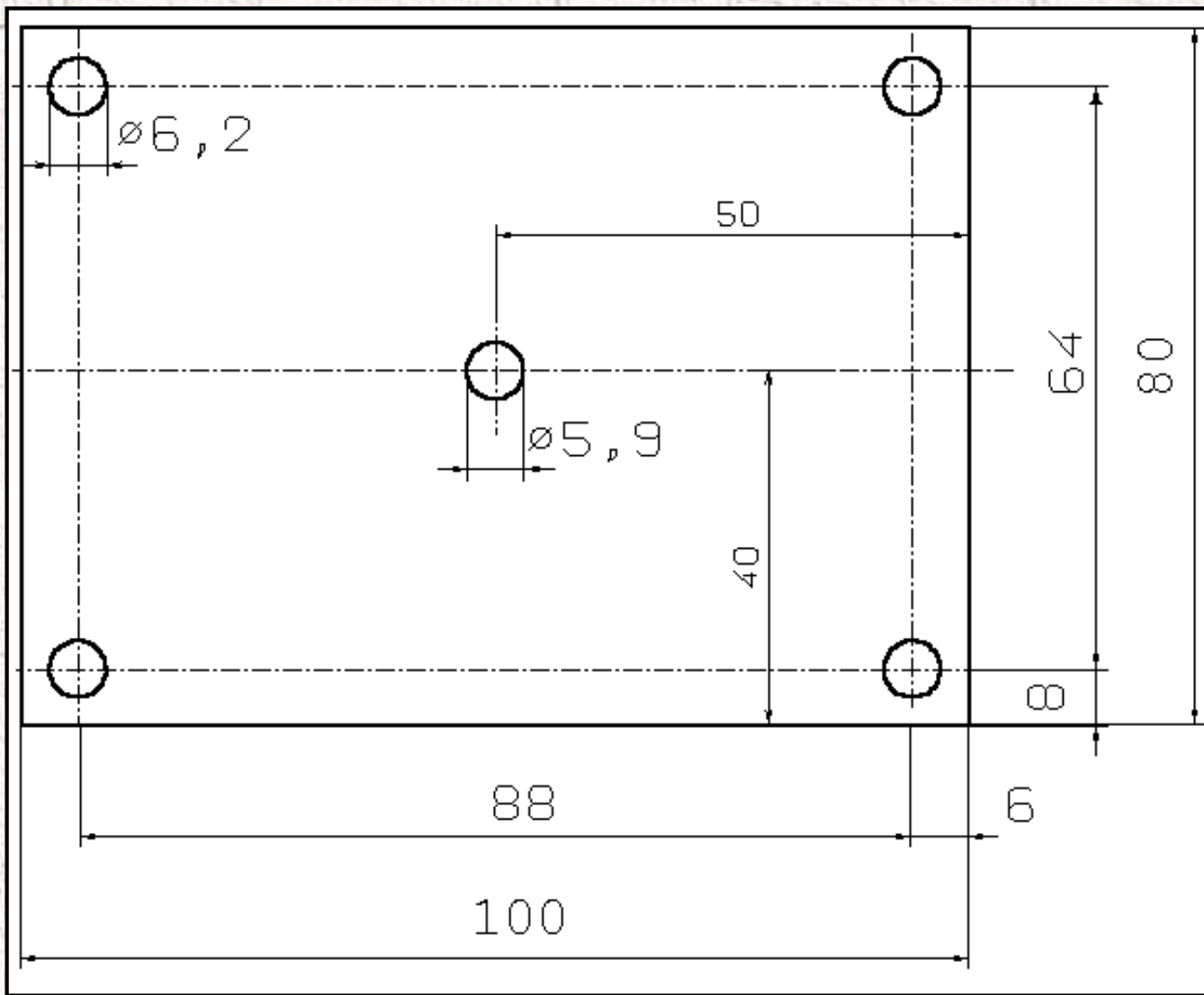

Last Update 03 December 1999. ON4CEQ Van Herck, Tony QTH: Anwerp( JO21FF ) BELGIUM.

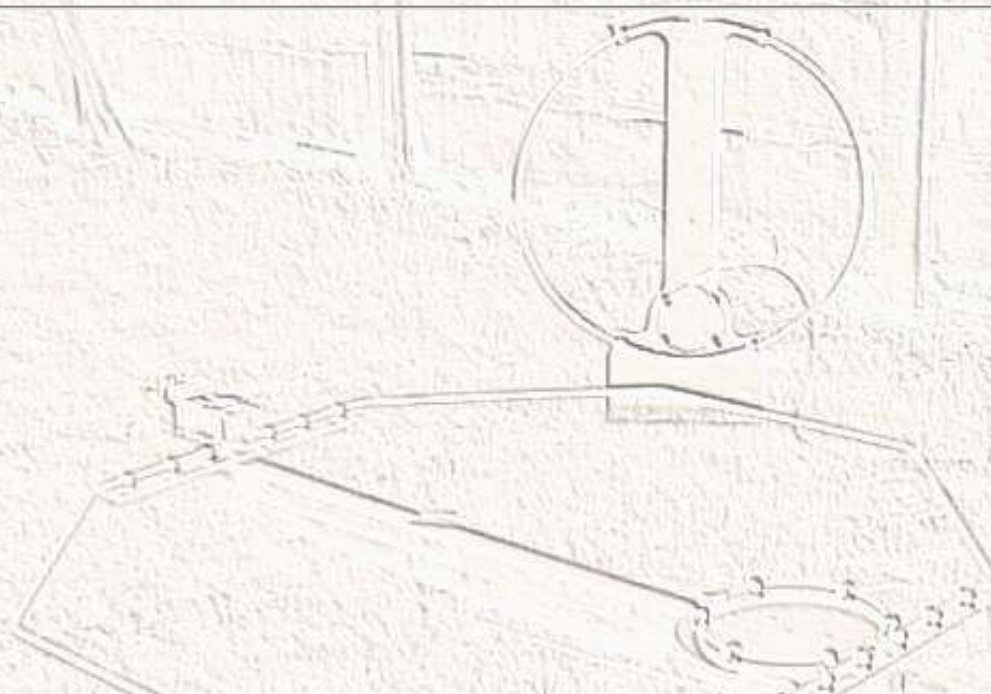



# RADIOINTEL.COM

*A Global Radio Portal*

[Front Page](#)
[DX Press](#)
[References](#)
[Reviews](#)
[Tips & Gear](#)
[La Prensa](#)
[★ Omnium-gatherum](#)

[Go](#)

[Go](#)

## THE WOODEN ALTAZIMUTH "HOOP LOOP"

A Saga by [Linus](#)



### BACKGROUND

It all started with finding a nice, wooden embroidery hoop at a local flea market, about 22 1/2" in diameter. Close to two feet across. It is about an inch and a half wide. I got to thinking about making it into a loop antenna, and since it was only three dollars, I went ahead and bought it, figuring the idea would hit me at some point. Well... After guessing, thinking, over the last few weeks, I just went into my shop and started building what my mind had started to see. What has resulted is a very stable, well-balanced and powerful loop antenna, light-weight and able to achieve deep nulls, and is so far really impressing me! It's in a fairly preliminary, 'prototype' stage, and improvements and additions are forthcoming, but for now read on...

### MAKING THE "HOOP LOOP"

I knew I wanted it mounted to a stable base/lazy susan for rotation, and that was easy. The big outer hoop mounts to a 9" square, 1" thick piece of plywood. Easy. Then, I wanted to make the inside hoop swivel to get an altazimuth feature like the big Kiwa model, which would surely assist in deep nulling of unwanted signals, noise and so on. Very carefully, I measured where my two points would be to hinge it with the best balance (more on balance later) and drilled the holes for the nylon screws I had in the junk drawer. It worked fine, and it swivels beautifully.

After drilling the holes and inserting the screws to test the ease of angling, I then removed the screws and began the tedious work of affixing the wire to the outside surface of the inner hoop. I realized I had to wind the loop in two sections, so that the screws for the altazimuth hinges could be accommodated. Measuring and testing, I found that I could wind 6 turns of #22 insulated wire on one side of the inner hoop, wound with no spacing between turns, THEN leaving about 1/8" space for the screw holes, and then another 6 turns to complete the 12 turn loop.

I thought about simply pulling the 7th turn away from the first 'set' of 6 turns, at the bottom of the hoop, and then continuing the rest of the winding, leaving two equally

sized 'sets' of windings, but continuous, leaving a space for the screws on the sides of the hoop... but this seemed kind of too quick and dirty for my mood. It will work though, but my method is kind of hard to describe.

I drilled four holes in the bottom of the inner hoop, and placed my starting end of wire into the farthest hole. Then, when I got to six turns (so long as you keep good tension on the wire as you wind it, it won't fall off the hoop. You could try to use tape or something to hold it, but it was pretty easy for me without it. Just keep it taut!), I cut the wire and inserted that end into the next hole. Pulling it through the hoop, I anchored that end to a small eyehook for temporary tightness.

Then I started another end of wire, following the same direction as the first set of 6 windings, and anchored the end to keep it tight, and finished the last 6 turns. Then, put the end of the winding into the last of the four holes I had drilled, and anchored that too. When that was done, I had two sets of 6 turns each, each set wound without spacing, but the two sets spaced from each other about an 1/8" apart to accommodate the screws for swiveling.

It's a lot easier to see it and do it than to describe it. See the images. (They're homemade MSPaint images, sorry if they're not clear enough).

Anyway, the two anchored wires from the center of the hoop (where the space is made for the screws) are soldered to each other, keeping them tight. Now you've got a continuous loop. The other ends of the loop go to a 365pf variable capacitor which rests on the inner hoop, inside the hoop. Again, see image to get the concept. Now, the loop will rotate side to side AND top to bottom.

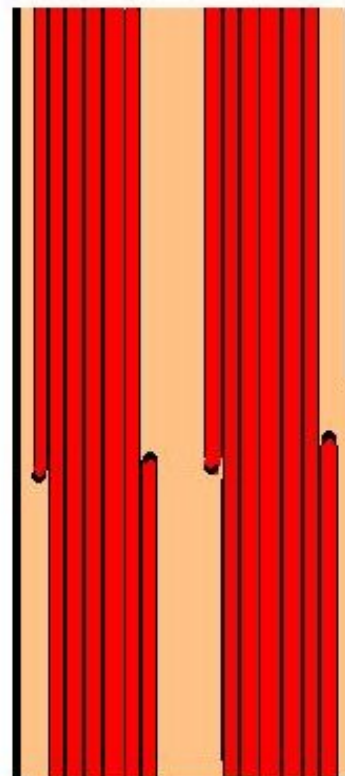

Detail of Loop Winding  
Bottom of inner hoop, underside view

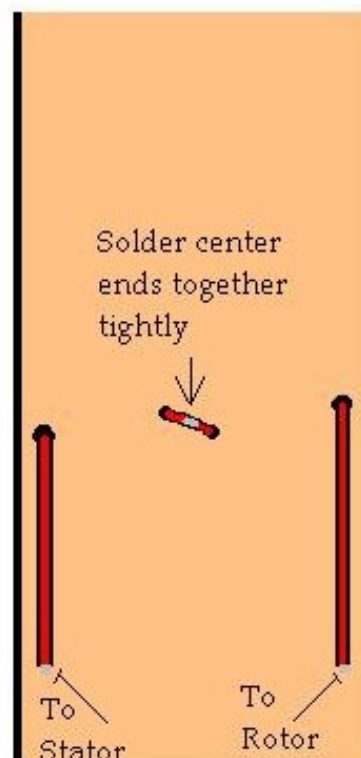

Detail of Loop Winding, Hook-up  
Bottom of inner hoop, Top view



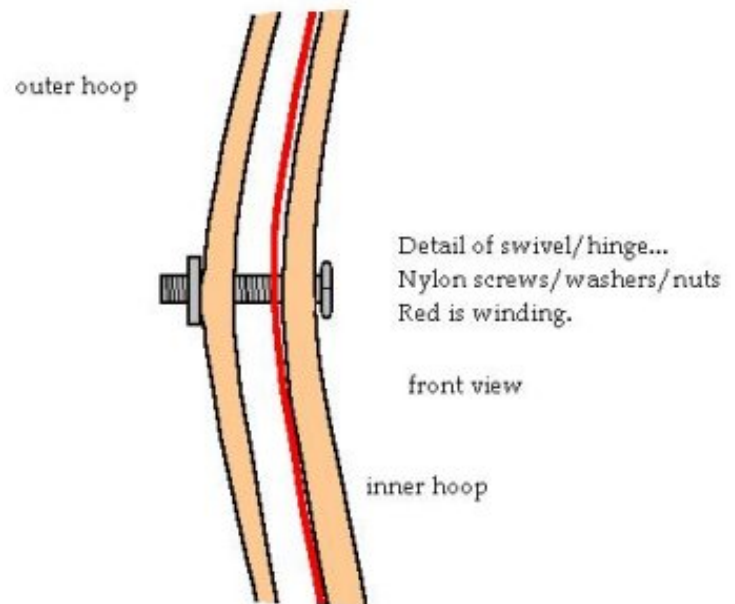

The next thing was to get it to lead out to my receiver (R75) which does not have a ferrite antenna built in. I spent some time on this question, then as a quick experiment I took a small ferrite rod, 3" I think, and wrapped it with about 20 turns of #18 insulated wire. The two ends of this winding I soldered to a length of small coax cable (RG174), one end to the center conductor of the coax, the other end to the shield/braid. The other end of the coax hooks into the + (center conductor) and -- (shield) terminals of the HiZ antenna input on the R75. I left enough cable to allow free movement and rotation of the loop, no less than a foot of cable. Too much cable might de-tune or upset the balance of the loop, but experts may be able to answer this question.

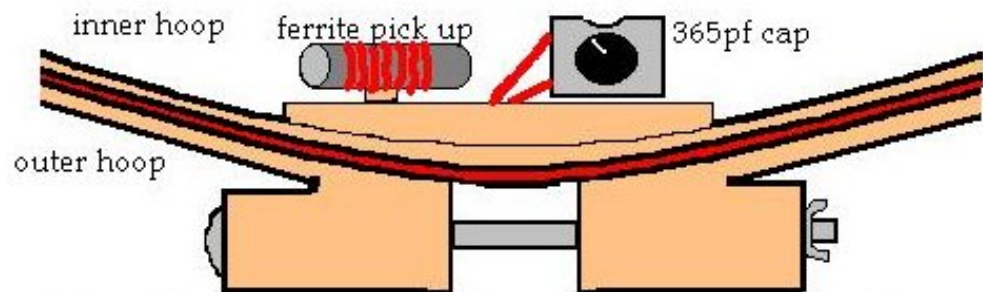

Base of hoop, front view, showing capacitor and ferrite pick-up coil (ferrite is slightly angled for clarity, it should be perpendicular!)

At any rate, the ferrite rod bundle is placed on the inner hoop next to the 365pf cap, facing perpendicular to the plane of the loop (just as you would place a portable radio in relation to a loop)... the ferrite rod is attached with some double-sided foam tape, but a more permanent mount can be created. This is, after all, a prototype! :-)

In order to get good balance, I had to mess with how wide I had the outer hoop opened up (recall, this is an embroidery hoop, you know the type, you have to open it up to place the fabric into it, and tighten it again to secure the work) and where the holes were drilled for the swiveling screws. I also had to add some counter weight to the top of the inner hoop to balance the weight of the 365 cap and ferrite bundle on the bottom of the inner hoop. I used some very sticky double sided foam tape, and attached a spent AA battery. Tried the swiveling, but still bottom-heavy. Then I added another battery and so on until I had five AA batteries up there, and now when I angle the inner hoop, it stays put in any position! Lucky me.

The obvious thing to do now is to find a decent weight that looks nicer and is a little more accurately weighted for really good balance for angling and staying put. Also, I want to add a varactor-tuned

system, to allow me to remove the small 365 air-core variable AND the ferrite pick-up loop, leaving one wire (probably RG174) coming from the inner hoop, to a small control box (tuning knob, circuit and battery!) at my fingertips. This would decrease the bottom weight of the inner hoop, and demand less counterweight accordingly. The coax to the receiver would come from the control box, not the loop, so no pick-up loop or ferrite is required, and therefore less stress and drag on the loop.

Also, it seems much better in null balance than any other loop I've used. Perhaps it's the two sets of windings rather than a single, spaced set of turns. All I know is, at night time, I can find the same dB of nulling at 180 degrees of either rotation. It's not skewed at all!

No, it's no Kiwa, has no Q-multiplication or amplifier, or heavy base for stability like the Kiwa, but the electronics can be added to the control box if I wanted to do so. It's light enough to be placed on a simple wooden base, and rested atop a plastic lazy susan, without stressing anything at all. It's very smooth in rotation and angling. I'll probably give the whole thing a good paint job when I'm done, to look a bit nicer (what are we if not civilized?) but even as it is, it's REALLY working well.

Nulls are deeper, sharper, than any other homebrew loop I have used, and the size of the loop FAR outperforms the S-A-T and the Terk loops, and in terms of nulling AND strong-signal handling, works better than the 4' box loop I used to think was my best loop (it was until now!)...

### RESULTS ARE QUITE IMPRESSIVE

Between 10:30 pm and 1 am, I was able to null two very strong locals, to complete silence, enabling me to copy two stations I had not been able to hear before. Ever.

Also, one of my age-old DX targets has been KNX1070, Los Angeles. I used to listen to them all the time when I lived there, but have only been able to hear them in SW Missouri once or twice over the last decade, even with an MFJ phasing unit and two very long wires. This loop was able to get rid of offending sports and gospel stations (well, 'offending' isn't really the word, I like sports and gospel music... I should say 'unwanted' stations!) on the same frequency, and while there was still some noise, I logged KNX1070 for the first time in years! All attempts at achieving the same level of clarity with the phased antennas could not compare to the loop. In fact, I could not hear the signal on either of the longwire antennas, and phasing only resulted in very weak copy with a lot of hash and two hets whining away in the background. In average conditions, this loop heard something that no other antenna \*I\* use could hear. Very impressive for me!

Daytime use has proven to me how deep and lasting the nulls this loop can achieve really are. Across the band, I nulled into oblivion all major stations in my area (560, 940, 990, 1060, 1220, 1260, 1510 and 1610, three of which transmit at full power less than ten miles from my location). It also picks up a number of daytime broadcasters within a five hundred mile range in a clean, noiseless manner which is superior to my longwires, phased or not, during the day. The signals are there on the phased array, and louder than the loop, but far noisier and when properly nulled are still much noisier than the loop gives me.

In short, the Altazimuth Hoop-Loop project has been WELL worth the effort, and only cost \$3 since I had everything else in the junk boxes. If I had to get it all new, it might be a \$20 project (the wire, about 70 feet of #22, the tuning cap is about \$10 from the Xtal Set Society, small and smooth-tuning, and the hoop, well, if you can find one, who knows? Cheap-cheap!)...

### WHAT'S IN A NAME?

I thought about calling this loop the KIWOOD Loop, but thought Craig S. at Kiwa wouldn't like that much. His loop is state-of-the-art, of course. The Termite's Feast? Washington's Teeth Special? The Lumber-Loop?

Whatever the name, this is a very worthy passive, altazimuth round loop, which covers the whole MW band and affords the user with excellent nulling and directionality. I like surprising myself! You may be surprised too!

Stay sincere!

**Linus, The GrtPmpkin** ☺✉

| [Disclaimer](#) | [Feedback](#) | [About](#) | **This page was last updated: March 21, 2003** |  
**Copyright ©2002-2004 [Radio Intelligencer](#). All rights reserved**



## Long Distance Medium Wave Listening

**by Steve Whitt (UK) & Paul Ormandy (New Zealand)**  
**Additional material by Andy Sennitt (Radio Netherlands)**



**Click on the PDF logo above to view this publication in Adobe Acrobat format, or right-click on the logo and choose 'save target as' (Internet Explorer) or 'save link as' (Netscape) to download the file to your Hard Disk (file size 1155k)**

**If you don't have Acrobat Reader, you can get it by clicking on the logo below and following the instructions**



1. [Introduction](#): What is Medium Wave DXing?
2. [Who Goes There?](#): What sorts of signals can you hear on MW?
3. [Getting Started](#): You don't have to be rich - or even awake!
4. [The Identification Question](#): Don't make assumptions
5. [DXpeditions](#): Giving up home comforts in pursuit of rare signals
6. [Equipment](#): The tools of the trade
7. [Antennas](#): To the MW DXer, a beverage isn't something you drink!
8. [Propagation](#): How Medium Wave signals reach your ears
9. [Interference](#): The sounds you don't want to hear
10. [Some Audio Samples](#): Eavesdrop on Paul Ormandy's receiver
11. [Reception Reports](#): How to verify your reception
12. [The Digital Dimension](#): The Future of MW DX in a Digital World
13. [The Wetter The Better?](#) How the weather affects MW signals.
14. [Clubs and Pubs](#): Further sources of information for the MW DXer.

MN Advice pages::

[Advice Index](#)

[Time](#)

[Jargon](#)

[Antenna](#)

[Long Distance MW](#)

[Reception Reports](#)

[Solar Guide](#)

[Lightning](#)

**Copyright notice:** This publication is copyright and may not be copied without permission. Publications wishing to reproduce sections of this medium wave guide should contact us at

Radio Netherlands  
att: Andy Sennitt, RNI  
P.O. Box 222,  
1200 JG Hilversum,  
The Netherlands  
**E-mail:** [media@rnw.nl](mailto:media@rnw.nl)

© 2003

[Send us an e-mail](#)

Radio Netherlands



# Dave's Radio Loops

Next



Dave's first homemade loop antenna.

## Introduction

Welcome of my homemade loop antenna pages. All the loops described here were designed and built by myself. The features are not real different from loop to loop. These loops are made to enhance radio reception in the broadcast band range. Some of the loops are just one coil, some have tuning capacitors and some have an extra coupling coil. Read on and discover the fantasy of loop antennas. Or fetish in my case.

The loop shown above is my first loop and it has only one winding. This ended up connected to my [4 tube radio](#). I used pine wood cut to 5/8 inches by 3/4 inches. There are three pieces 12 inches long and another 16 inches long. The squares in the center are about 3x3 inches and are 3/16 inches thick.

The wire is 23 gauge enameled magnet wire, but you can use what you have and what looks cool. There are 15 full turns of wire. I drilled 15 small holes starting 3/8 inch in and at 3/8 inch intervals. The bottom leg (the 16 inch long) has an extra hole at the bottom so the winding will start and end on that section of the loop. You will have to spool out 70 feet of wire and thread it all the way through. Be careful that the wire doesn't kink and you should have a big enough space and two people to do this job. I did it by myself, but it took a long time to wind this loop.

After the loop is done, take a piece of wood, or some left over garolite like I did and drill two countersink holes to attach to the frame and two more holes for the connection hardware.

I made the base with two pieces of oak wood. One is about 7 inches square and the other is 4 inches square. Use what you have. Sand, stain and shellac the wood, then attach them together with 4 flathead wood screws. Drill a 1/4 inch hole in both the base and the loop and put in a dowel rod to attach both together. If the dowel doesn't easily go in, sand it until you get a better fit.

Check out my [crystal loop](#) antenna/receiver.

## Loop For My Old Sparton Radio

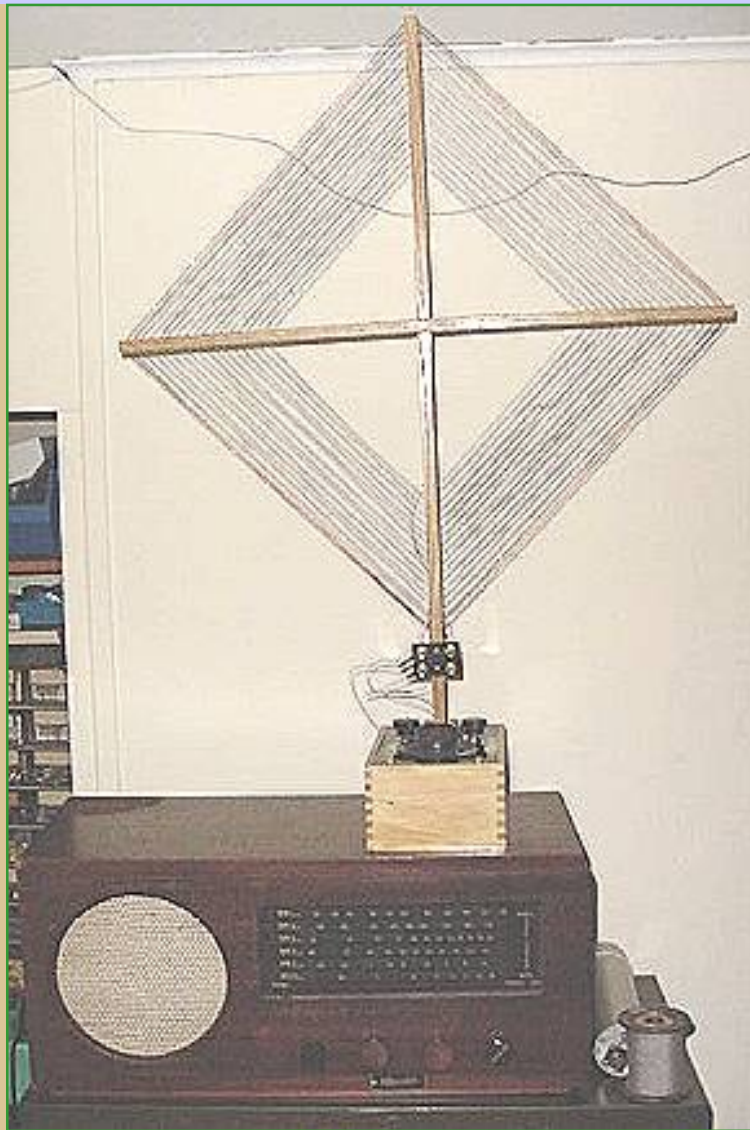

Here it is friends. I made a loop specifically for one radio. This my loop #6. I was using my "test" loop (which is shown below) to see how my Sparton radio would perform. I was impressed and since I use that my Sparton a lot, it deserved it's own loop.

I decided that this antenna had to be *lightened up* a little. The two garolite squares had to go. I cut a notch in both pieces of wood so that they would interlock. The pieces are glued and fastened with a single flat head wood screw.

The wire is wound with some of my litz wire. Litz isn't really necessary but the wire is more flexible than the magnet wire. This makes a nice looking wiring job when finished. You will need 70 feet of wire for the tuning coil and about 14 feet for the outer coil. I thread the wire for my loops outside where there is room to pull the wire. The drilling and other details are contained in the drawing shown below.

I used litz wire between the loop terminals and the base box. Earlier I had used 18 gauge PVC covered wire. This was too stiff and the loop would not stay in the position it was turned to. Just one of those little learning things.

A base box isn't necessary. All the parts could be mounted on the loop itself, or a small board could hold the loop with a small panel for the other parts. But I like those basswood boxes that I have.

The Sparton radio is a multi band set and the shortwave bands require a different antenna. I added a switch and some



terminals to accommodate this need. The radio antenna is switched between the loop coupling coil, or an external antenna and ground. The other switch is a high low band switch and adds a 300 pf capacitor across the 365 pf variable capacitor. A larger value of variable capacitor would tune the whole band in one chunk.

This loop is not real expensive to build, but they require a lot of building time. Use your imagination and you will be as proud of your loop as I am of mine.

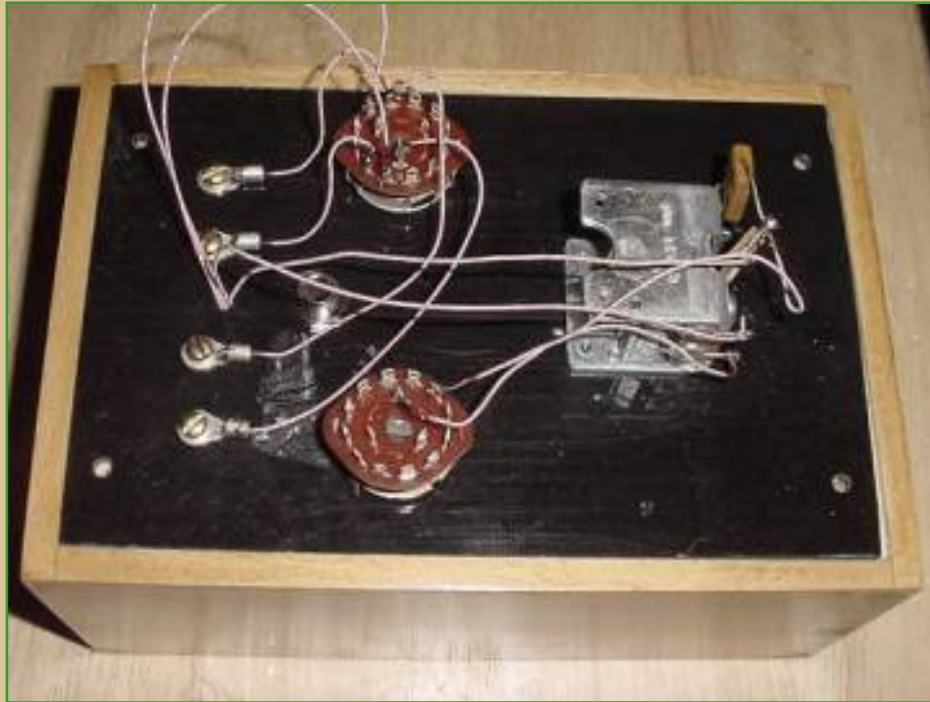

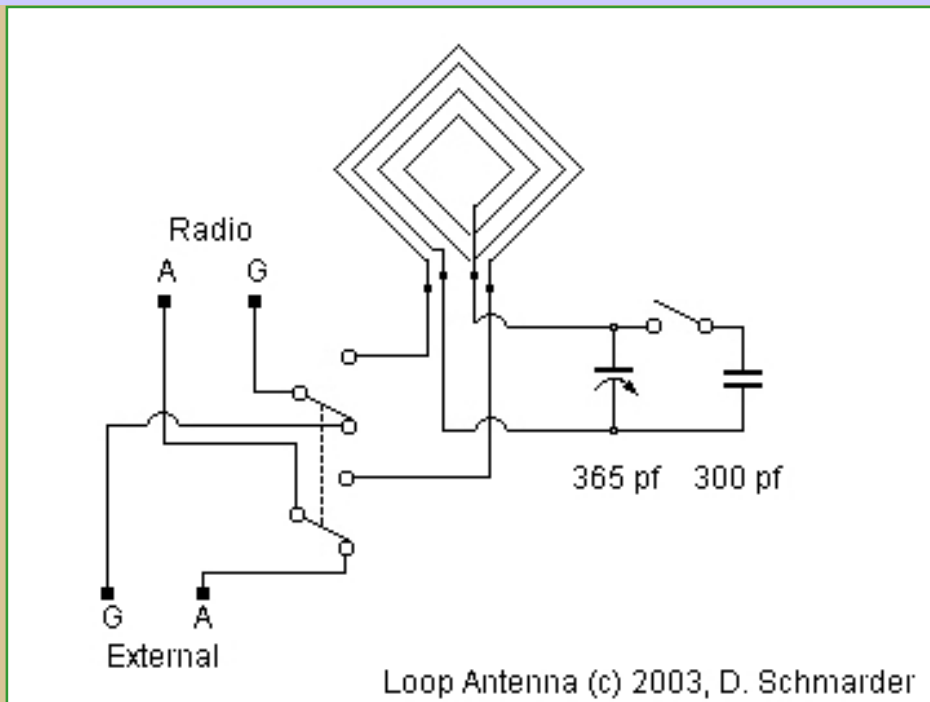

Loop schematic

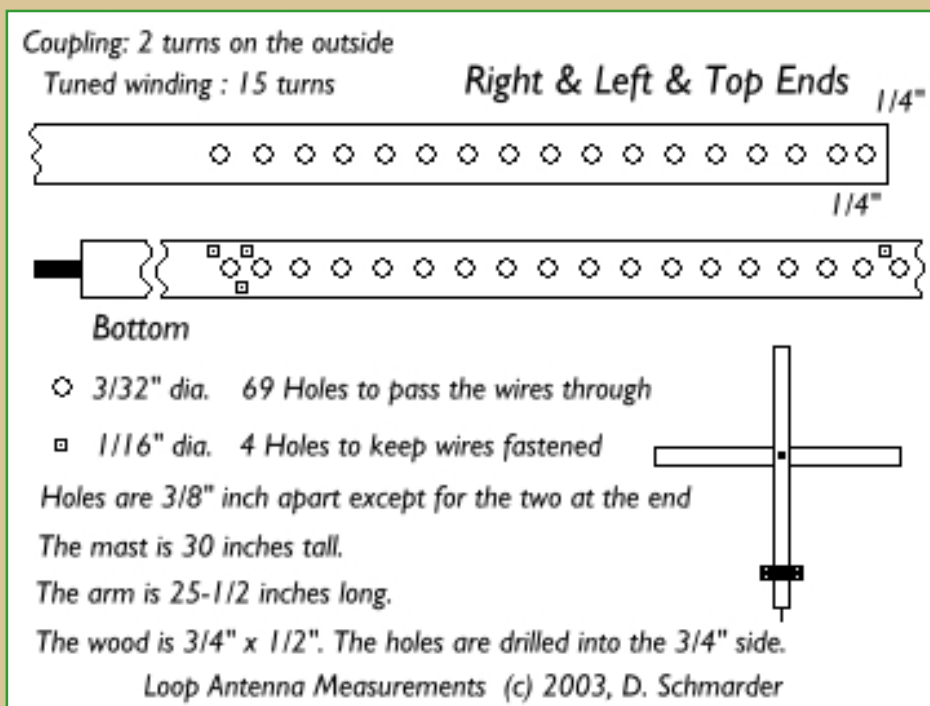

Hole drilling detail for my homemade loops.

## R & D Loop



This is my 4th loop. Sorry for leaving #2 and #3 off the site, but those were so much like my first that I decided I would wait for something worthwhile to offer. This is worthwhile. I wanted a loop with lots of bells and whistles to do my radio experiments. Look at what this loop has to offer.

This loop has two windings. The larger winding (15 turns) is connected to a variable capacitor for a large tuned circuit. Since a single 365 pf capacitor will not tune the entire broadcast band, more capacitance has to be added. In the case of my dad's loop (shown below), he switched a 300 pf fixed capacitor across the 365 to allow tuning down to 540 khz. I am using a ganged capacitor and a switch. Included is a third position of having no capacitor across the coil. I did this as some of my radios tune the antenna loop by a ganged capacitor inside the radio.

The other winding (2 turns) is to connect to the antenna input of the old BC radio. I picked two turns as that emulates the single turn that my dad had on his larger loop.

This loop has 3 wood pieces. The arms are 12-1/2 inches long, and the main pole (vertical part) is 30 inches tall. This is

a little larger than my earlier loops so that I would have room for that extra winding. After the holes are drilled, I stained the oak with Minwax Red Mahogany stain. After the gloss dft dried, assembled the loop using two 3x3 inch square pieces of garolite. Thin wood, plastic or anything you have around will work. Before you mount everything, fit it together and take a look to see if it looks right.

Another change from my first loop is how the ends of the wires are handled. So that the wire wouldn't work loose, I drilled an extra hole close to each end hole on my loop. This makes 2 extra holes I had to drill. What the heck, holes are cheap so I splurged. The extra holes are about 3/16 inch from the end holes. The wire can be then looped around a couple of times. This holds the ends secure and looks neat too.

On the top of the mast pole and each side arm, I drilled 17 holes. I used a 3/32 inch drill but it isn't too important the size of the hole. Each hole is 3/8 inch from each other and I started 3/8 inch from each end.

Then measuring down from the top of the pole 25 inches, I drilled a series of 21 holes going back up the pole, 15 holes, one for each turn, one for the end winding. Then two extra holes close spaced for ending the tuned winding. . When the wire is wound on this loop, it will look like a square.

Three more holes are drilled for the untuned winding. I looped the both wires once through the middle hole as with this winding, having the ends so close wouldn't matter. I think that comes out to 21. Lets see....  $15+1+2+3=21$ . Good thing I stayed awake in the first grade!

You with me so far? Good. After I wound the wire, I made a little 4 terminal connection block from another piece of garolite. I also drilled a 1/4 inch hole in the bottom of the pole and inserted a dowel rod in the hole. This is the weak point of the loop. If the loop falls over the dowel will break and need replacing.

Next I built the box that serves as a base for the loop and holds the capacitor. I used a cut down basswood box, a piece of 3/4 inch thick oak as a base and some 1/8 inch garolite as a panel. I took a 1x1x3 inch piece of wood and screwed it to the garolite. This is so the 1/4 inch dowel will be stable in the loop base.

Using that big thick 14 gauge wire, I make the connections to the capacitor and link switch. In my case, I used a 3 gang capacitor. That made it easy to use a single link switch to do what I wanted it to. You could make two spst link switches, one to add a fixed or second gang and the other to disconnect the capacitor from the circuit. I built mine the way I wanted, and you can build yours any way that is handy for you.

So I can use this loop several ways:

Connect a radio to the untuned 2 turn loop and tune the main coil with the capacitor.

Hook an antenna and ground to the two turns and a diode and earphone on the tuned side for a cool crystal set. Or if I was really close to the station, forget the antenna and ground.

Use the untuned winding as a tickler coil in a regenerative set.

Use only the large loop without the tuning to connect to a radio. This loop could be used to replace a built-in loop on a radio.

Connect the coupling loop between a wire antenna and a crystal set for a wave trap. Make sure the loop is turned to null the station you want to trap.

Maybe I could use this loop to strain my spaghetti. Anyway, below are some pictures of how I constructed the loop. If something is unclear or you have a better idea on something, please e-mail me. These loops are very cheap to build but take a long time to make. But they sure look cool sitting on top of your old radio. Best of luck with yours!

Dave



Top of panel with loop plugged in.

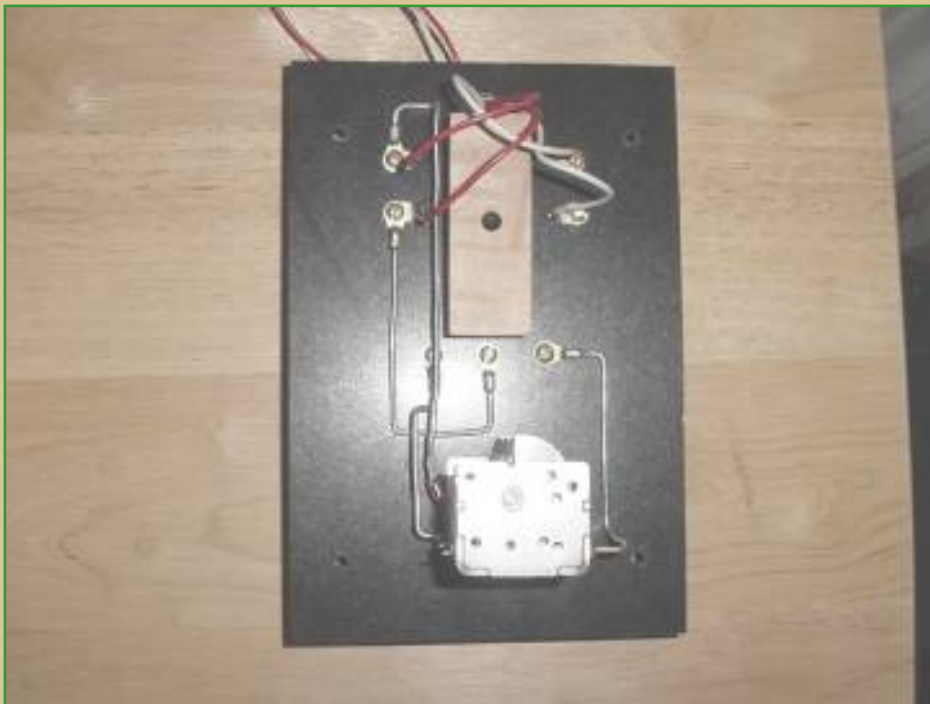

Underneath view with old time wiring.



The bottom base box.



Panel view with loop removed.

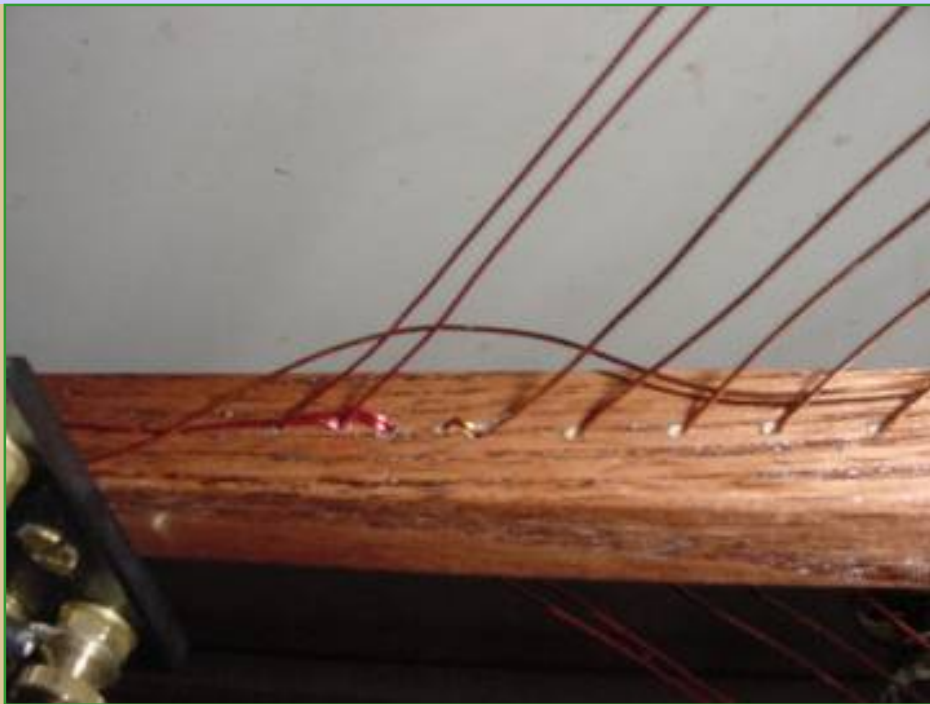

Bottom of pole showing end wire looping.



Left side arm showing 17 holes with wires.

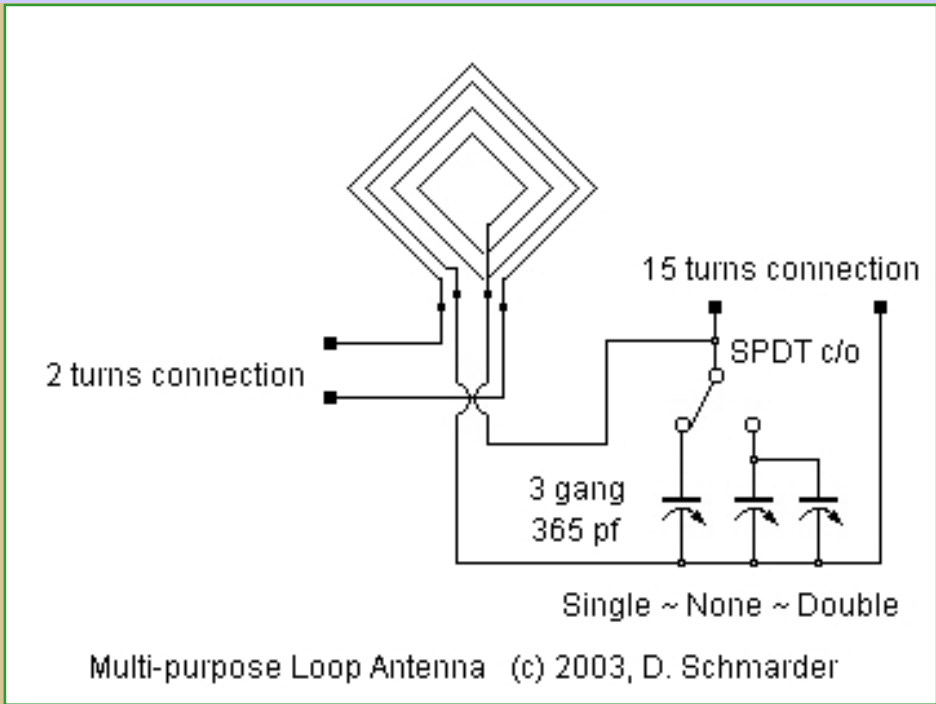

Schematic

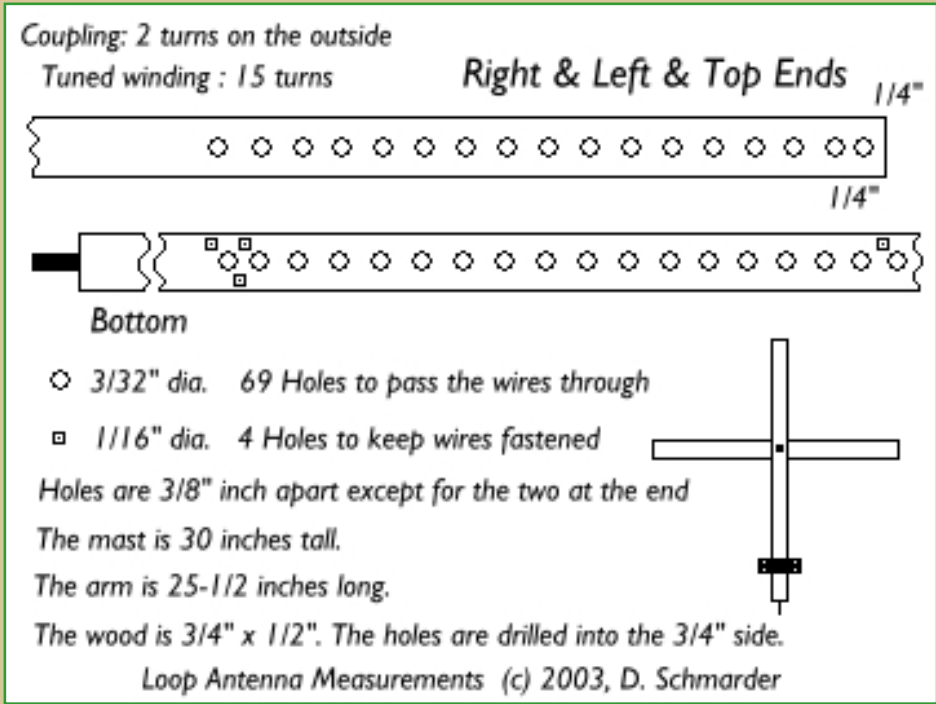

Hole drilling detail for my homemade loops.





[Schmarder.com](#) [Dave Schmarder](#) [Radios](#) [For Sale](#) [Homemade Radio Accessories](#)

### Contact Information and conditions

This page updated last on undefined  
by(c) by David Schmarder

SEARCH:

# Surplus Sales of Nebraska

*Where the hard to find parts are found...and on hand!!*

Air Variable Capacitors

## Air Variable Capacitors, Shafted



Single Section



Dual Section



Triple Section



Quad Section

[Home Page](#) > [Index Page](#) > [Capacitors](#) > [Air Variable Capacitors](#)

- [Single Section](#)
- [Dual Section](#)
- [Triple Section](#)
- [Quad Section](#)
- [5 or More Sections](#)
  
- [Capacitor Index](#)

Related Links

- [Air Variable Capacitors: Differential](#)
- [Air Variable Capacitors: Slotted](#)
- [Butterfly Capacitors](#)
- [Trimmer Capacitors: Ceramic](#)
- [Trimmer Capacitors: Compression](#)
- [Trimmer Capacitors: Piston](#)

For more information,  
e-mail: [grinnell@surplussales.com](mailto:grinnell@surplussales.com)

[ [ORDER FORM](#) ] | [ [HOME PAGE](#) ] | [ [INDEX PAGE](#) ] | [ [SITE MAP](#) ]

© 2003-2004 Surplus Sales

# RECEIVING LOOP AERIALS FOR 1.8 MHz

by Lloyd Butler VK5BR

Originally Published in Amateur Radio September 1990)

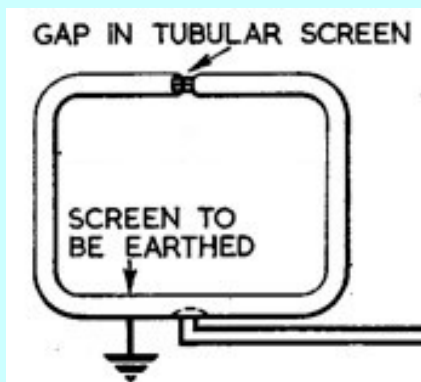

Basic Shielded Loop

Localised noise in the receiver can be reduced by using a small loop aerial. Shielded coax loops, unshielded loops and ferrite rod loops for 1.8 Mhz have been compared here. Best performance has been achieved with with 6 & 1/2 turns unshielded on a 0.8 metre frame and connected via a balanced interface amplifier.

## Introduction

The theory of how a small loop aerial can reduce locally generated noise is described in [a previous article](#).

In the March 1982 issue of 'Amateur Radio', Clarrie Castle VK5KL described a receiving loop aerial for 1.8 MHz. The octagonal shaped loop, some three metres in length and breadth, was formed by a single turn of coaxial cable, the outer braid of which provided the electrostatic shield. From all accounts, the aerial was very successful in improving the received signal-tonoise ratio in the presence of localised noise interference.

It seemed to me that perhaps the same performance could be achieved with a loop of smaller dimensions but with more than one coaxial turn. This would allow operation in a more confined space and even inside the radio shack. With this in mind, the performance at 1.8 MHz of an 0.8m square multi-turn coax loop aerial has been investigated. Also examined is an unshielded version of the same sized loop aerial and a ferrite core loop aerial made for the 1.8MHz band. The performance of each is individually discussed and then compared.

## Loop Sensitivity

For a tuned loop oriented to give maximum signal (that is, its plane in line with direction of signal source) the loop sensitivity ( $E_s/e$ ) can be defined as follows:

$$E_s/e = (2nNAQ)/\lambda$$

where  $E_s$  = Output Voltage from loop

$e$  = Field strength in Volts per metre

$N$  = Number of loop turns

$A$  = Loop area in square metres

$Q$  = Loop Q factor

$\lambda$  = Wavelength in metres

### Three-Turn Loop

Comparing the 0.8m square loop to the larger VK5KI, loop, the area is only 0.64 square metre compared to 6.2 square metres for the latter. This reduction factor of around 1:10 means a loop sensitivity loss of around 1:10, but this can be partly compensated by increasing the number of turns. However, increasing the number of turns also increases the inductance of the loop and its inherent shunt capacitance thus reducing the loop natural resonant frequency. This frequency must be higher than the operating frequency (1.8 MHz) otherwise it cannot be tuned to the operating frequency.

Three coax turns of 0.8 metre square appeared to approach this limit, and an experimental 0.8m square loop was assembled with three turns of 75 Ohm TV coax. There was no particular reason for selecting this type of coax except that I happened to have a piece just the right length! The construction of this aerial is illustrated in figures 1 and 2. Observe that the outer braids of each of the coax turns are broken at the apex of the loop, and all braids are joined at the base of the loop. The square loop is oriented with its diagonals vertical and horizontal. The reason for this is that it is convenient to mount the loop interface box, with its connection to the loop, on one of the crossed pieces of wood which support the loop. It also makes it convenient to hang the loop from a hook in the wood at the apex.

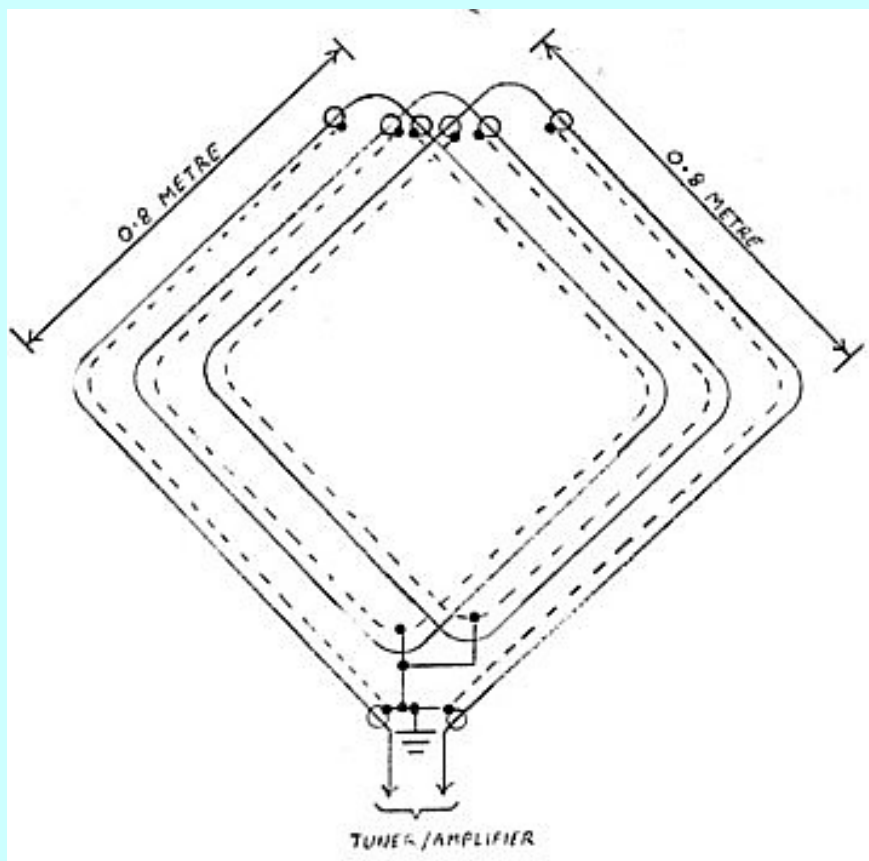

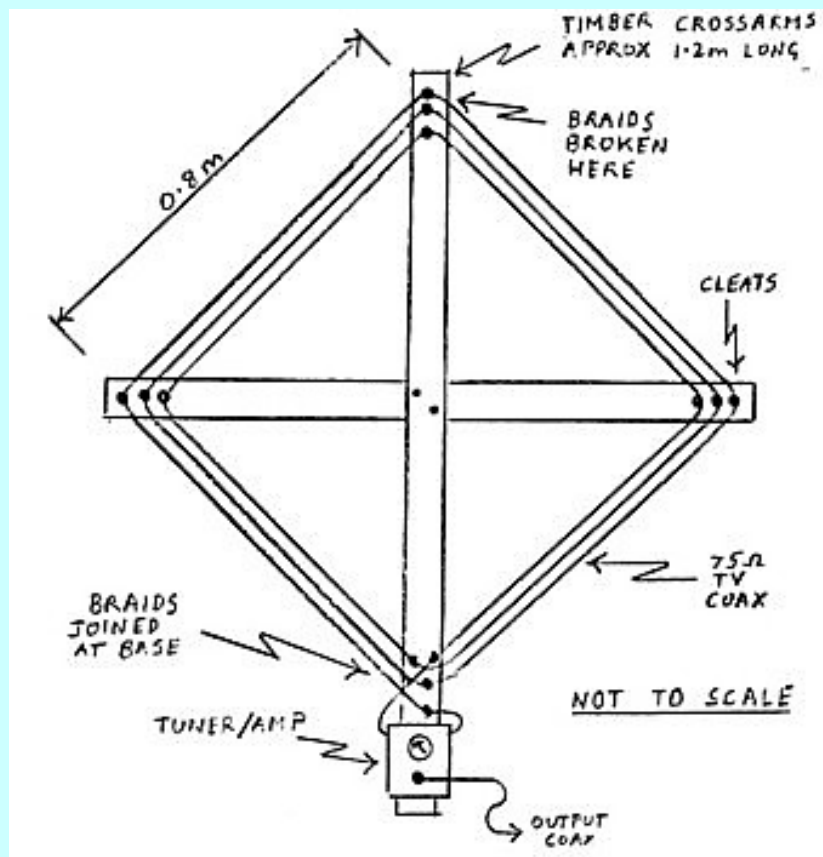

**Figure 1 - 3 Turn Coax Loop Aerial  
Circuit Diagram**

**Figure 2 - 3 Turn Coax Loop Aerial  
Assembly**

The increase in the number of turns of three to one does not fully compensate for the loss of 1:10 in area. However, the smaller three-turn loop measured a Q factor of 54 compared with 16 for the larger one-turn loop. The net result of all this was that loop sensitivity ( $E_s/e$ ) calculated as 3.9 for the smaller loop compared with 3.7 for the larger loop. Hence their performances could be expected to be much the same.

The natural resonant frequency of the three turn loop was found to be around 3.5 MHz and well above the 1.8 MHz operating frequency. It is possible that four turns could also have provided a natural resonance above 1.8 MHz, with a possible further improvement in sensitivity. However, this was not checked out.

### Unshielded Loop Aerial

Theory on how a shielded loop aerial reduces localised noise interference was given in my earlier article on loop aerials for VLF-LF (Reference 1). If localised noise is not a problem, loop sensitivity can be improved by not shielding the loop. This reduces the loop self capacitance and hence the number of turns for a given upper frequency limit can be increased. I found that seven turns of light gauge hook-up wire, spaced 5mm apart on the 0.8m square frame, produced a natural resonance of 2 MHz, just conveniently above the 1.8 MHz required. The Q factor at 1.8 MHz measured 39 and loop sensitivity calculated to a value of 6.5, which is very close to a value calculated for a 10m high vertical aerial.

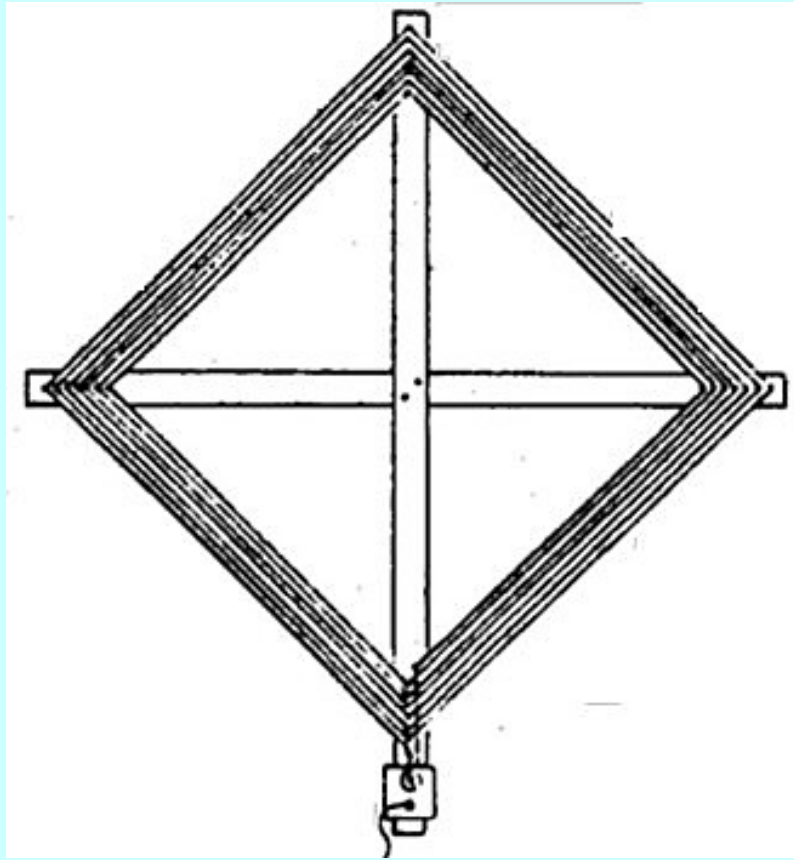

**Figure 3 Unshielded Loop Aerial**

### **Conductor Size**

As we have discussed earlier, the loop sensitivity at resonance is directly proportional to its Q factor which, in turn, is the ratio of its inductance to series resistance. The resistance is the sum of radiation resistance and the AC loss resistance in the loop, the latter being the prominent factor as the value of radiation resistance is very small. The AC loss resistance can be reduced by increasing the surface area of the loop conductor.

The original seven-turn unshielded loop was wound with 0.4mm diameter wire and produced a Q factor at 1.8 MHz of 39. The wire was ultimately replaced with a 1.7mm stranded conductor to improve the Q. A side effect in doing this was an increase in the selfcapacitance of the loop, making it barely possible to peak the loop tuning at 1.8 MHz. To correct for this, the inductance was reduced by reducing the number of turns to 6.5 or, more correctly, one of the seven turns was returned from halfway around the loop across one of the crossarms so that the one turn had half the area of the others. The larger diameter conductor increased the Q factor to around 100. It would have been higher had it not been limited by the 200 kOhm input resistance of the interface amplifier. Correcting for the reduced area of one turn and the increase in Q, the loop sensitivity ( $E_s/e$ ) was derived as a value of 15.6, considerably higher than the 6.5 derived for the 0.4mm conductor.

In all fairness to the original VK5KL large single-turn loop, I must point out that this was made with RG8 coax, which has an inner conductor diameter around 2.2mm compared with the smaller diameter 0.8mm conductor in the coax used for my tests. The Q factor of the VK5KL loop might well have been much higher than I have quoted and hence its sensitivity greater. It also follows that I could have achieved higher sensitivity in my three turn coax loop had RG8 been used. However, it is assumed that relativity between the signal sensitivities of the two shielded loop

forms tested would have been much the same had the larger cable been used in each..

## Loop interface

To obtain the best advantage of the high Q factor of the loop (and hence its highest sensitivity) the loop is tuned to resonance at the operating frequency and connected via a high impedance input interface circuit. For the experiments described, this was achieved with the circuit shown in figure 4.

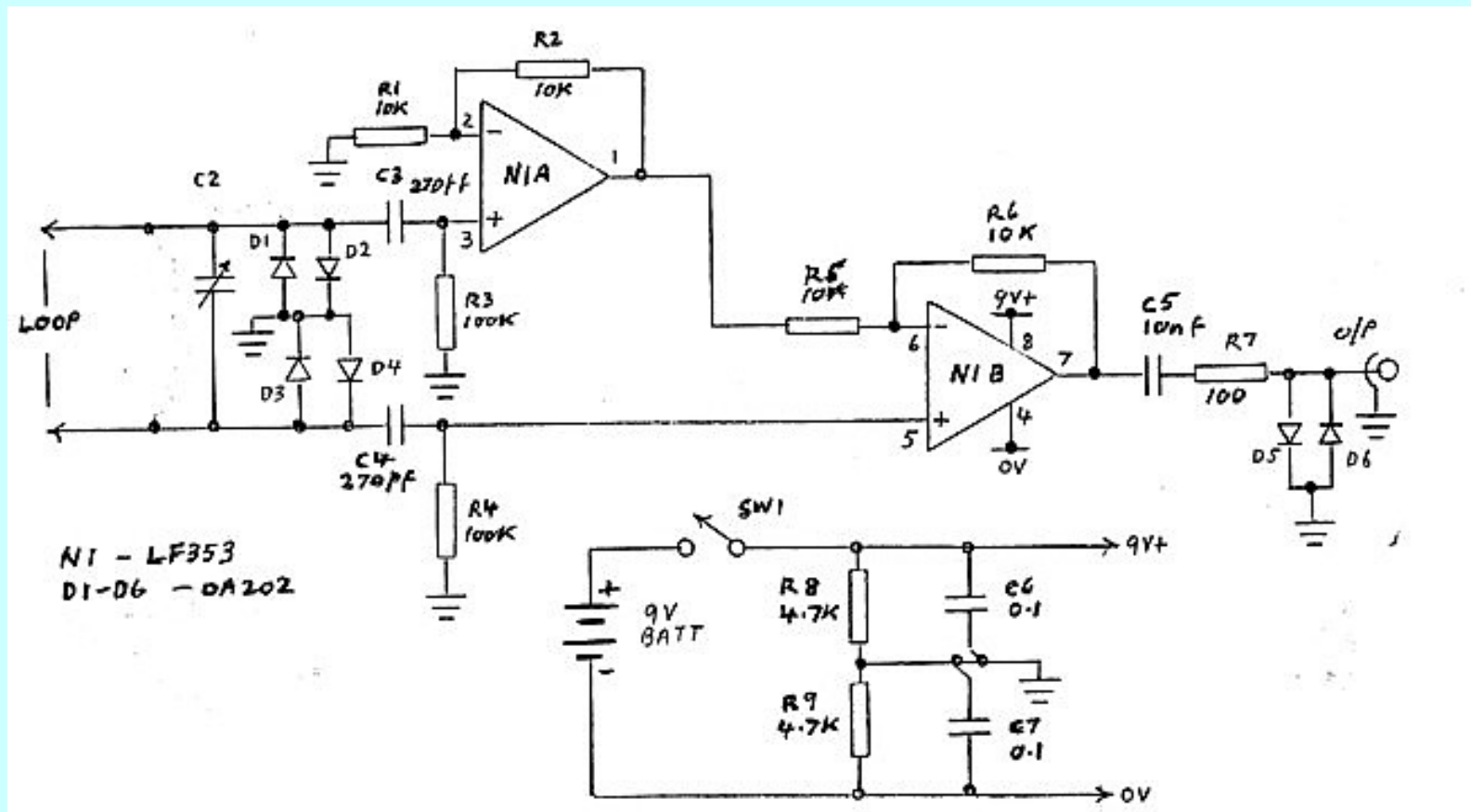

**Figure 4 Loop Tuner and Interface Amplifier**  
 For 6 & 1/2 Turn Loop, C2 is 3-56 pf miniature variable Capacitor

The circuit makes use of twin JFET amplifier package type LF353 connected for balanced input. For the benefit of those who might not be quite familiar with operational amplifier theory, we will examine the stage gains. In the amplifier circuit around N1B, the gain via the inverting input is defined by the ratio  $R6/R5$  and since  $R5$  and  $R6$  are equal, the inverting gain is equal to -1. However, the gain via the non-inverting input is defined by the ratio  $R6/(R5+R6)$  and hence the non-inverting gain from the lower loop connection in the diagram is equal to 2.

The other loop connection is fed via the non-inverting input of N1A. As the circuit around N1A is identical to that around N1B, it also has a gain from the non-inverting input of 2. Since this connection of the loop is in anti-phase to the other connection, its signal via N1A must be inverted in mixing with the other signal in N1B. This is done via the inverting input of N1B without change of amplitude.

The loop aerial output is equally shared between the two amplifier inputs and hence the overall gain, balanced to unbalanced, is 2 or 6dB. This is about the limit one can get from the LF353 package at 1.8 MHz as its gain-

bandwidth product is 4 MHz.

Tuning of the loop is set by variable capacitor C2 and, where necessary, parallel fixed capacitor C1. The input circuit resistance is 200 kOhms, set by R3 and R4 in series. This is sufficiently high to prevent the loop Q from being lowered excessively.

The output resistance is largely set by R7, included for stability. Operational amplifiers can be very temperamental if operated directly into a capacitive load (such as a coaxial cable) without some series resistance.

The multitude of diodes at input and output are protection against excessive RF signal which might happen to be fed in. At the home installation, the loop aerial amplifier was connected via a switch into the receive side of the transceiver transmit/receive relay. This provided an interlock to prevent feeding the transmitter directly into the loop circuits. However, there was still a concern about RF induced from the transmitting aerial back into the loop and hence the diodes were included.

The amplifier circuit provides a very high impedance to low impedance conversion without loss of signal voltage developed by the loop Q.

### **Ferrite Core Loop Aerials**

A further exercise was carried out to compare the performance of the loop aerial wound on a ferrite rod with that of the larger air-wound loops. Whilst this type of loop aerial has a very small loop area, the loss in area is compensated by the large number of turns which can be used and a high multiplying factor determined by the ferrite material permeability. For the aerial oriented to give maximum signal, the loop sensitivity formula is expanded to the following:

$$Es/e = (2nNAQu')/\lambda$$

**Where u' = The corrected permeability**

Permeability requires some explanation. Permeability (u) of the material is the multiplying factor which applies to the inductance of the winding compared to when it is air wound, assuming all lines of magnetic flux pass through the winding. In the ferrite rod, not all lines of flux pass through the winding, so there is leakage flux. The inductance is therefore less, and a multiplying factor called rod permeability (u<sub>d</sub>) applies. Curves relating rod permeability to material permeability, for different rod length to diameter ratios, are published in the ARRL Antenna Handbook (reference 2) and in Amidon Associates brochures.

The corrected permeability (u') is the multiplying factor applied to the loop formula. If the coil winding is the full length of the ferrite rod, then corrected permeability is equal to rod permeability. If the rod is longer than the winding, the corrected permeability is increased as follows:

$$u' = u_{rod} \times \text{cube root}(a/b)$$

**where a = Length of the rod**

**b = Length of the winding**



To carry out my tests, I purchased a ferrite rod (Cat L1401) from Dick Smith Electronics. The rod dimensions are 20cm. long by 9.5mm diameter. No information seemed to be available on permeability, hence the rod permeability was derived by calculating the ratio of inductance, measured for a given number of turns on the rod, to that for the same sized winding in air. The inductance in air was determined by two different methods which gave much the same answer. The first method was to apply the well-known Wheeler's formula for air-wound coils which can be found in many handbooks. The second method was to wind the same number of turns on a length of bamboo which happened to have the same diameter as the rod, and the inductance of this coil was then measured. The value of rod permeability was determined as 74, and from the curves previously mentioned, material permeability appeared to be around 120.

To operate at 1.8 MHz, 64 turns of 0.44mm single-core PVC-covered wire were wound around the ferrite rod. For this number of turns, the maximum which could be achieved, self-resonance was just above the 1.8MHz band at 2 MHz. The 64 turns occupied 7cm of the length of the rod and, from this measurement, a corrected permeability of 81 was derived.

The Q factor of the loop at 1.8 MHz was measured as 57, and loop sensitivity was calculated as 0.86, considerably less than all the air-wound loops discussed.

### Comparison of Loop Sensitivities



The characteristics of the various loop aerials discussed are compared in Table 1. Despite its smaller area, the 0.8m square coax loop (B), with more turns and higher Q, has a signal sensitivity as good as the larger single-turn coax loop (A). With a self-resonance at 3.5 MHz, well above the required frequency of 1.8 MHz, it is probable that the sensitivity of (B) could have been improved further by adding another turn, still being tunable to 1.8 MHz.

The additional turns made possible by not shielding the seven-turn loop (C), enabled a higher signal sensitivity to be achieved comparable with that of a 10m vertical aerial (F). The importance of using a large sized conductor to reduce AC resistance is shown by comparing aerial (C) with aerial (D), which is similar to (C), but which has a large diameter conductor. The sensitivity of (D) is considerably higher than that of (C).

The ferrite rod loop aerial (E) works quite well because of the high permeability of its core, but it is no match in terms of signal sensitivity when compared with the larger air core loops.

### Operational Performance

With the various loop aerials connected in turn to a receiver, the relative signal levels received followed much the same pattern as loop sensitivity shown in Table 1. Signal levels received on the three turn coax loop were comparable with those received on a sloping wire Marconi aerial loaded for 1.8 MHz and normally used as the transmitting aerial. The unshielded loops, with more turns, delivered considerably higher signal levels than the sloping wire. Some of the extra level is due to the 6dB gain in the interface amplifier but, even taking this into account, there was still quite a level difference.

Quite apart from the ability of the loop aerial to reduce interference from a localised noise source, its directional properties can be used to improve the signal-to-noise ratio in the presence of atmospheric noise. This particularly

applies if the noise has a directional property and the loop is oriented so that its null position faces the direction of maximum noise. Of course, the same technique can be applied to a source of QRM. For these applications, the unshielded loops, with their higher signal sensitivities, seemed to work best and they clearly improved the readability of signals otherwise difficult to copy on the sloping wire.

One would expect that the coax loop aerial would be more suitable than the unshielded loop in an environment of high local noise. Notwithstanding this, the seven-turn unshielded loop did not appear to be any more sensitive to localised noise which was introduced in the radio shack.

In actual fact, the unshielded loops could be expected to have quite reasonable rejection of the electric field component when operated into the type of interface amplifier circuit used. The electric field component of localised noise is the one which is the highest level and this is induced into the loop in a common mode with equal voltage at the loop output terminals referred to ground. The amplifier has a differential input circuit and hence the electric field component is essentially balanced out (see footnote). If the balance is good, there would appear to be a lesser need for electrostatic shielding to reduce localised noise. The additional shield might be needed more in using the loop for accurate direction finding (DF) work where a small amount of pick-up as a vertical aerial (called vertical or antenna effect) could make an error in the position of the signal null.

The ferrite rod loop aerial has an advantage in its small size and suitability for portable applications. However, its performance when connected to a receiver did not match that of the 0.8m square loops.

## Conclusions

The performance of 0.8m square loop aerials for 1.8 MHz has been discussed. It is concluded that a three or four-turn coax loop aerial of this size would work as well as the larger single-turn coax loop aerial. The discussion has also extended to experiments with the ferrite rod loop aerials. As stated earlier, the aerial has its limitations.

By using a loop of unshielded turns to reduce the capacitance, the number of turns and hence the loop sensitivity, can be increased. Provided that the unshielded loop aerial is operated in a balanced mode, rejection of localised noise is still quite good. Loop sensitivity is dependent on its Q factor, and to achieve a high Q, the conductor size, or at least its surface area, should be as large as practicable.

Provided that the loop circuit is well balanced, I see little point in shielding the loop unless accurate DF work is envisaged. Some texts describe a step down coupling transformer to interface the loop to the receiver input. As a preference, I favour the use of the high impedance amplifier for the following reasons: Firstly, the transformer reflects a load from the receiver input and this must lower the loop Q. Secondly, the transformer provides a high-to-low-impedance transfer with step down of voltage. The amplifier does this as a voltage follower, or even with voltage gain. The only precaution is that the amplifier must be selected for a noise level below that received expected from the loop. The higher the loop sensitivity, the less is the chance of this being a problem.

**My recommendation for a good performance 1.8MHz loop aerial, small enough to operate both inside the radio shack or outside, is six or seven turns of a heavy gauge copper wire spaced 5mm to 10mm on a 0.8m square frame (See Figure 3). As an alternative to ordinary wire, one might consider connecting up the outer braid of the old style heavy shielded wire or some discarded coax cable. Connect via the interface amplifier of figure 4. Use an input tuning capacitor 3-56pf (miniature variable). The amplifier is mounted at the base of the frame to keep short connecting leads to the loop.**

1. Lloyd Butler VK5BR - [VLF-LF and the Loop Aerial](#). - Amateur Radio, August 1990.
2. C H Castle VK5KL - A 10 ft Diameter Receiving Loop Aerial on 1.8 MHz - Amateur Radio, March 1982.
3. The ARRL Antenna Handbook 15th Edition 1988 - Chapter 5, Loop Antennas, and Chapter 14, Direction Finding Antennas.

#### Footnote

I have pointed out in the text that when the loop is connected via the differential input circuit the electric field component is induced in a common mode against earth and is essentially balanced out by the circuit. This should be qualified as being conditional on the loop dimensions being small compared with a wavelength. If the plane of the loop is in line with the direction of signal, a phase difference must exist between the voltages induced into each side of the loop. This will develop a differential voltage between opposite sidewires of the loop. In the loop aeriels discussed, the distance between the sides of the loop is 0.8m, small compared with a wavelength of 160m. Hence, the phase difference is small and the voltage generated is also assumed to be small.

[Back to HomePage](#)

Posted on rec.radio.shortwave

# SHORT & EASY MEDIUM WAVE LOOP ANTENNA

From: Ron Hardin  
Date: Tue, 01 Jul 1997 15:15:15 -0400  
Organization: AT&T WorldNet Services  
Newsgroups: rec.radio.shortwave

Short and easy MW tuned loop construction, with Radio Shack parts:

Build an 18" square wooden frame, 2" wide, to wrap wire on; wrap 14 turns of thin insulated solid copper hookup wire around it (buy 100' of say #22 insulated wire, \$5.00), spacing it out, and attach the ends to the leads of a variable capacitor. (You can extract the variable capacitor from a Radio Shack crystal set kit \$8.00) Duct tape the capacitor to the wooden frame of the loop.

Done!

Place a radio inside the loop, tune to a station, and wiggle the capacitor knob for maximum; there's an amazing increase in signal strength DURING THE DAY. There's not much effect seen at night because the signals are already too strong.

If the capacitor is too noisy when tuned (you have to wiggle for a sweet spot)? You could get a real one from an old radio, or buy one also at Radio Shack. The variable capacitor should be 365 pf or higher value.

Removing a turn of wire raises the frequency range of the loop; adding a turn lowers it. The thing tunes slightly less than the whole band,

This at least gets you started and you can see what you'll get.

You can also turn this into a crystal set by adding a high impedance earphone, and a diode. Wire the earphone in series with the diode and place these in parallel across the capacitor/loop.

--

Ron Hardin

- 
- Back to the [DX News and information page](#)
  - Back to the [Utility News and Information page](#)

- Back to the [SPEEDX Shortwave and DXing Home page](#)

***Although we have made every effort to ensure the reliability of our sources, we do not assume responsibility for their accuracy. Standard disclaimer applies!***

# How to Get Better AM Radio Reception

Last updated March 7, 2003.

## Introduction

AM radio offers challenges for good reception. It is more susceptible to various kinds of interference, both natural and man-made, and sometimes it's hard to find a radio that gives you decent AM reception. But I enjoy many stations on AM for the programming they offer, and have searched out ways on my own to get better AM reception. I will share them with you here.

I've spent considerable time searching the internet, and haven't found a web-site devoted to helping the average person get better AM radio reception. I hope this web site fills that need, and offers some help. I've tried to keep this as non-technical as possible. Also, please remember that any reference I make to any specific product is my opinion, and that it is your responsibility to be a careful consumer. Shop carefully, whether on-line or in person, and be aware of the seller's return policy (just in case) and any product warranties. :-)

## AM Radio Reception

---

### The Antenna is 90% of Your Radio

Who ever thinks about the antenna for AM? Yes, for FM you have the rod antenna that you pull up and move around, or that piece of wire that came with your stereo that most people leave dangling in a tangle behind the entertainment center (then wonder why their FM reception is no good...).

Your AM radio has an antenna, too. In most portables, transistor radios, boom-boxes and table radios, the AM antenna is built in. It consists of a ferrite rod around which is wound thin wire. Since we don't see this antenna, we tend not to think about it, but it's there nevertheless.

This antenna is directional-- that is it picks up signals from some directions better than others. This built-in antenna is best at picking up stations coming in from a direction perpendicular to the rod. It is least sensitive picking up signals coming at it end-on. This phenomenon can be used to your advantage. To get a station in better, try turning the radio. By doing so, you are aiming the antenna inside for a better signal. And if there is interference, you may be able to get the antenna rod pointed end-on toward the interference, thereby reducing it or cutting it out completely.

What if you have a nice stereo system, with a receiver or a rack system? In those cases, the AM antenna is often a loop of wire wrapped around a small plastic frame that you connect to AM antenna terminals on the back of the stereo. Let's hope you didn't throw this away with the packaging. If you did, get a length of wire, maybe 20 feet or so, and wrap it around something non-metallic to make your own loop. You might try using a cheap plastic food dish, for example. Wind it around its circumference, then strip the ends of the wires and connect them to the AM antenna terminals. As with the ferrite rod described above, it is directional, so experiment with the correct placement.

Many old stereo tuners and receivers had the ferrite rod antenna mounted to the back of the cabinet on a hinge. Again, experiment with aiming it for the best results.

---

## Buying a Better Antenna

Still need more signal? Try a better antenna. I'll tell you up front, sometimes this isn't pretty. And it can be dirt-cheap, or very expensive. Sometimes when you walk into the local electronics store and ask for a better AM antenna, the sales clerk will look at you like you have 2 heads. But don't give up. Take a print-out of this sheet and stand your ground.

### • The Cheap, But Effective Long Wire

The old fashioned long-wire antenna may work for you. But to use it you need two things:

- An AM antenna terminal on your AM radio, and
- Some place you can string up 50-75 feet of wire

If you can't do this, read down for ideas on indoor antennas.

The long-wire antenna is simply a long copper wire strung between two high places, with a lead-in wire going to the AM antenna terminal of your radio. RadioShack sells these items as a pre-packaged kit (catalog #278-758, \$9.99 in their 2000 Catalog.) I have provided [instructions on building a long-wire antenna](#) on a separate page.

### • The RadioShack Indoor AM Loop Antenna Catalog Number 15-1853

This is an attractive loop, about 12 inches in diameter, with a tuning knob. "Fully adjustable antenna electrically matches specific AM frequency you are trying to receive..." You put it next to your radio, tune the knob for best reception. It couldn't be easier! There's an antenna jack on the

back for hookup to AM antenna terminals if you have them. (RadioShack catalog # 15-1853 \$29.99 in the 2000 Catalog)

## • **The Terk AM Advantage, Model AM-1000**

[Terk](#) makes an indoor loop antenna for AM radio. It is a 12" loop that is very attractive, and can sit next to your radio. As with the RadioShack antenna above, you put it next to your radio, tune the knob for best reception. It couldn't be easier! There's an antenna jack on the back for hookup to AM antenna terminals if you have them, and it comes with a short cable for that purpose. I bought one myself for \$50 at a local stereo store. Look around, ask, and see if someone can order it if they don't carry it.

## • **The Select-A-Tenna**

This is another tunable loop like the Terk AM-1000, but is reputed to be even more powerful. I haven't personally tried this one, but it has a good reputation. It comes in several versions, one of which includes a regenerative amplifier to really boost reception. It is available by mail-order from:

- [The C. Crane Company](#) Based in California, they specialize in things for listening to radio. They have an on-line catalog.
- [Universal Radio](#) a company specializing in products for Amateur (Ham) Radio operators and shortwave radio listeners.

## • **The Kiwa Loop: Very expensive, very nice.**

The Mother of all AM Antennas. I wish I had the \$350 bucks for this one. If you do, again you can get one from:

- [The C. Crane Company](#)
- [Universal Radio](#)

This is an amplified tunable loop antenna that can be aimed both in the horizontal and vertical planes. It uses what is called a "regenerative amp" to take a small amount of signal and boost it to usable levels. In the process, it also increases the selectivity of your radio (the ability to "zero in" on a signal stuck between two others on the dial). This antenna is intended for people who are dead serious about their AM radio, and use a high-quality communications receiver, although theoretically one could use it with the RadioShack 12-603 or the GE Superradio III or even a good stereo receiver, since they have antenna terminals. I've seen pictures and read articles about this antenna. A couple of technical friends of mine drool over this, and they hope that their ship comes in someday so they can buy one. So do I. But like I said, it costs over \$350.00! Be very careful to



ask about the seller's return policy on this item, especially since it is special order!

---

## Sources of Interference

But the antenna is only the start. You also have to deal with interference. AM radio is more susceptible to natural and man-made interference due to the way the signal is carried over the air and demodulated (or "decoded") in your radio. The following things can cause interference on your AM radio:

- Florescent lights
- Nearby businesses with neon signs, or lots of florescent lights
- Light dimmer controls (including your neighbor's if you're in an apartment)
- Touch lamps (the kind you touch to turn on or off)
- Television sets
- Computers and computer monitors
- Electric motors
- Dirty or faulty insulators on nearby electrical utility poles
- Radio equipment or medical equipment in your neighborhood (such as a nearby police station, hospital or clinic)
- Microwave ovens
- Electronic Bug Zappers and Electronic Pest Controllers
- A lightbulb that is about to burn out
- Automatic lights (indoor or out)
- Hard-wired smoke detectors
- Blinking lights (such as Christmas lights)
- I've even gotten interference in my car from traffic light controls, and also every time I drive past a police station (they have electronic equipment in there that cause interference).

The idea is to shut off any sources of interference that you can. Sometimes this is difficult, as you can't ask the bar next door to shut off its neon sign. But control whatever interference you can.

Sometimes moving the radio to a different location, or even turning it (so the internal antenna is aimed in a different direction) may be enough to reduce or eliminate interference, yet still leave enough signal to listen to the station you want.

If you are not sure where the interference is coming from, get a battery operated radio. If the interference disappears, then it was coming through the AC power line. RadioShack and other retailers of electrical parts and accessories sell AC Line Interference Filters that can reduce this kind of interference. If the interference does not go away, then it is coming through the air.

If this is the case, use the battery operated radio as a "direction finder" to locate the interference. Tune to a weaker station, and walk around with it until you come to where the interference is strongest. If it turns out that the interference is strongest near a utility pole, call the electric company, and see if they'll come out to wash or repair the insulators on the pole. Otherwise, you have the source of the interference, and if it is something you can control then you're all set. **Caution!** Do not mess with electrical circuits or devices unless you are a qualified technician. Leave that to the professionals as it is dangerous.

---

## Radios that are Good for AM.

Unfortunately, AM radio is often an afterthought when they're designing home entertainment products. It's a sad fact that the \$2000 super-duper surround sound system you just bought probably has an AM section no better than a cheap clock radio, if it's even that good! Maybe manufacturers believe there's no demand for a decent AM section, though the fact that you're here reading this is probably proof that their wrong! (There are a very few exceptions, McIntosh being one that comes to mind, but their stuff is mucho-mucho expensive!)

Still, if you care about your AM reception, there are a some portable radios out there that do a good job at receiving stations. The products I mention here are the ones that I know about costing less than \$100 (with one exception at \$159.95). Although there may be others that also do well, I haven't been able to evaluate them myself. Remember, your results may vary, as reception is different for everyone, although I would suggest that if these radios cannot pick up the station you want when used with a good antenna, it may not be possible.

As with anything you buy, always ask about the return policy of the store or dealer and ask about the warranty *before* you buy, in case you need to return it, or have a problem. RadioShack's ESO - "Extended Service Option" is available on many of their products, and is a good deal. RadioShack's policy with their ESO is usually to forget the fine-print and make the customer happy. Always save the receipt and packaging, no matter where you buy! Be a smart shopper!

- **RadioShack High Performance Radio (cat# 12-903, \$59.99 as shown on the RadioShack web site.)**

**I reviewd the now-discontinued version of this radio, the 12-603. I have not had an opportunity to thoroughly evaluate the new version, but after a short evaluation I believe it to be essentially the same radio with cosmetic changes.**

Most radios under \$100 give you mediocre reception, but this is one radio that excells! It's called the Radio Shack High Performance Radio. It is specifically designed for people who want good

AM reception. It has a good built-in antenna and high performance tuning sections that provide great reception and sound. It has a bandwidth switch for AM that allows the radio to narrow the "reception window," to use a non-technical term, so you can zero-in on a station and cut out interference from stations on either side on the dial. You can also switch to Wide mode to open up this "window" and get better sound quality when there's no interference. In Wide mode the sound quality is so good that with a strong signal, your friends will think you've tuned into FM!

It has terminals on the back for both AM and FM antennas (which is rare on portable AM/FM radios). It has nice sounding built-in speakers, using a 5" woofer for good bass and a tweeter for clean highs. The sound quality is very nice, no matter what kind of music or programs you enjoy. It also gets good FM reception. It runs on batteries or AC. It is similar to the GE SuperRadio III, and is rumored to be made by GE with the RadioShack name on it, but this cannot be officially confirmed and I have heard there are actually some significant differences between them. I know the speaker is smaller, and the ferrite rod antenna may also be shorter. I have not verified the latter difference personally. It's sold and warrantied by RadioShack.

The list price is \$59.99 as of 03/07/03, and it goes on sale every once in a while.

## • **The GE SuperRadio III**

This is the most well-known high performance AM radio currently available. It is the one that the RadioShack version is based upon. There are those who say it out-performs the RadioShack version. I have not personally verified this. This is the Mother of all AM Portables. It has a very good built-in antenna and high performance tuning section that provides great reception and sound. It also includes a bandwidth switch. This switch can be set to "narrow" to zero-in on a station and cut out interference from stations on either side on the dial, or switched to "wide" to open up and get better sound quality when there's no interference.

It has antenna terminals on the back for both AM and FM (which is rare on portable AM/FM radios). It boasts a powerful amp, and a big 6" woofer for good bass and a tweeter for clean highs. It sounds as nice as a decent boom-box. It gets good FM reception, too. It runs on batteries or AC.

The price varies. I've seen it at some places for \$59.95, and other places for less. I recently saw one at Sears for \$49.99.

## • **The CC Radio**

The CC Radio, manufactured by Sangean for the [C. Crane Company](#) is designed specifically for AM Radio listeners. (It also includes FM, TV Sound and the Weather Band with alert.) I have not tested this radio personally, but have read some excellent product reviews in some major magazines, and it has been recommended by a visitor to this web-site. The published specifications

look good. It is reported to be very sensitive and selective (meaning it can "zero in" on a station located on the dial between two other stations). The sound quality is tailored to the range of the human voice, making it great for listening to talk shows and news from distant AM stations. It sells for \$159.95 (as of 05/27/2000 in their magazine ad), including shipping. Yes, a bit expensive, but remember that this is a specialty product designed for someone who really wants good reception. It includes antenna terminals, and is reported to perform well on FM as well.

---

## Is there a strong signal in your area?

### Know When to Hold 'Em, Know When to Fold 'Em: You can't hear what isn't there.

Everything I write from here on down assumes that you have already have a decent AM radio and antenna, but even if you don't, or can't use a good antenna for whatever reason, the following information is still important.

- **Daytime Stations and Reduced Night-Time Power** If your favorite station is a small daytime only station, you won't be able to receive it after sunset. While this may seem obvious, you would be surprised at how many folks come to me because they can't pick up a particular station at night, and it turns out to be a daytimer. Some stations don't go off the air altogether, but reduce their power to very low levels, and can't be picked up more than a few miles away after dark. If you are not sure if your favorite station shuts down or reduces power at night, you can call the station, or check the station databases I have links to on the main radio page.
- **Small Transmitters** Sometimes an AM station station may be broadcasting with low-power, and just not reach your location. While having a good radio and antenna is important, there has to be some signal in the air for your radio to pick up to begin with. Again, many people don't realize this is the case.
- **Directional Transmitter Antennas** Many radio stations have directional antennas; that is, they concentrate the signal in one direction or towards a particular geographic area. This is often done to prevent interference to other stations in the area, or to concentrate the signal where the greatest number of people may live. For example, the huge 50,000 watt WBZ near my home town has an antenna that beams the signal west-- which makes good sense, since there is no point in wasting power broadcasting out over the Atlantic Ocean! Likewise, the little college FM station that I was on (Oh! Those carefree college days!) beams it's signal to the south, to avoid interfering with another station close on the dial to the north of us. AM stations do this also. One local AM station

in my area has a directional antenna that beams half the signal over the ocean, and the other half clean across some of the finest undeveloped woodland in the state. What were they thinking? As a result, hardly anyone can get it. Local radio engineers joke that they are "feeding the fish."

This sometimes explains why your friend who lives the same distance in miles from the station, only a few towns over, can get the station while you can't. It may be the station's antenna is aimed at his or her town, and away from yours. So, try to determine where you are in relation to the station's transmitter-- not just in terms of distance, but also in terms of direction? Again, a call to the station or search on the databases I've linked to may answer this question for you.

- **Obstructions between You and the Transmitter** An obstruction between you and the transmitter, such as a mountain or tall buildings sometimes blocks the signal. And as I explain below, the construction of your house or office may block AM radio waves.
- **Where is the transmitter?** Sometimes the transmitter is located in a different city from the studio. For example, the transmitter for 680 WRKO Boston, Massachusetts is a few miles west of the city in a town called Burlington. And the transmitter for 1030 WBZ Boston is a few miles to the south-east in the town of Hull, Massachusetts. Getting certain "Boston" FM and AM stations I like is a challenge as many are located as far as 25 miles north of Boston! (And I, obviously, live 30 miles to the south.) Those extra miles can make a difference. Just because a station says on the air that they're in "Your City" doesn't mean much for reception because their transmitter and antenna may be in "East Overshoe." Why do they do this? Well, first of all, where are you going to put up four 500 foot tall antenna towers in the middle of a city, and second, the prestige of being associated with a bigger town or city lends to the station a certain air of authority that can attract advertising dollars. Hence, stations petition the FCC to allow them to identify themselves as being where their studio is, in the city, rather than where the transmitter/antenna is, often way out there. Again, a call to the station, or a look at the on-line database will answer this for you.
- **Listening from inside Certain Buildings** Sometimes people can't get any AM reception in certain places, such as their workplace. I often hear this complaint. The building may be made of metal, use reinforced concrete walls (metal rods in the concrete to strengthen them) or have a metal roof. There may be computers or machines that cause interference, and hundreds of florescent lights in the ceiling. They may get no AM reception at all-- even on the huge 50,000 watt powerhouses. Unfortunately, there is not much one can do here. I always suggest putting the radio by a window, and the usual reply is that their desk or work-station is too far away from the window to do that, and they wouldn't be able to turn it up loud enough to hear it over the noise, or without disturbing their co-workers from that far away.

If you can string an antenna to the outside of the building, try that, although again sometimes that's not practical. (C. Crane Company offers a version of the Select-A-Tenna for this application.) One customer of mine lived in a trailer-- a metal trailer, and couldn't get anything! He got the RadioShack 12-603 (mentioned above) and ran a wire outside from the AM antenna

terminal. Now he's happy as he can pull in even the weak stations. Again, that depends on what your situation is, and what the boss will let you do.

If this isn't possible, it may be time to consider using a cassette or CD player, and leave the radio listening for home.

## **Tape it, like you tape TV shows!**

So you can't get your favorite AM station at work to listen to that talk show, or maybe you can't listen because of the nature of your job. So tape the show. One visitor to this web-site suggested putting the radio and tape recorder (a boombox may work nicely here) on one of those light timers you can get for a few bucks. Tune in the station, press the record button then unplug it, plug into the timer, and set the timer. Of course, the longest cassette you can buy is 120 minutes, 1 hour per side, two hours if your cassette recorder auto-reverses. It's better than nothing. Also, a couple of the above mentioned companies offer special radio-recorders that can get up to 8 hours on a single cassette! They do this by modifying the cassette recorder so it runs the tape very slowly to fit 8 hours onto a 1 hour tape. Of course, these specially-recorded tapes can't be played on a regular cassette player, but a couple of these companies also offer special personal tape players with headphones that will play the tapes. This way you can listen at your convenience.

Or, use your VCR. That's right, I said "VCR." An engineer friend of mine uses a HI-FI VCR to do this. He runs a patch cable from the headphone jack of the radio to the audio input on the back of the VCR, switches the VCR to the line-input (consult your VCR's instruction book on how to switch to this input) and has it record at the SLP (also called EP) speed so he can get 6 hours on a T-120 tape. Play it back through your stereo if the VCR is hooked up to it, or just use your TV (you'll hear the program but the screen will be blank, obviously). Although I haven't tried this with a non HI-FI VCR, it may still work. Not all VCRs can do this, but if you have one, try it! This feature may not be documented in your VCR's manual. Remember, for this to work, instead of using the external timer, you program the VCR to come on at the right time, and the radio is already turned on and tuned to your station. Again, for instructions on programming specific VCRs, consult your owner's manual. (Please do *not* e-mail me asking how to program your VCR! There are hundreds of models out there, going back nearly 20 years --how time flies! -- and I only worry about my own VCR and my Mom's. The rest of you, please read the manual, or enlist the help of your friendly neighborhood whiz-kid!)

## **Other Resources**

[RadioShack](http://www.RadioShack.com) As they say, "You have Questions, We Have Answers!" They say that over 90% of the population lives within a 5 minute drive of a RadioShack. Plus, as you know from reading this, they have a lot of the stuff you need for better AM listening.

[DX-ing.com](#) A resource provided by Universal Radio for people interested in receiving long distance (hence, "DX") radio and TV signals.

[The C. Crane Company](#) offers information on their web page about getting good AM reception (in order to sell their products, of course, but the info is good).

[Grove Computers and Radio](#) A company offering products for better radio reception, also publishing the magazine "Monitoring Times," a publication for radio enthusiasts.

[Better AM Radio Reception](#) a page with some tips for getting better AM radio reception.

[Return to the Radio Reception and Resources Page](#)

[Go to the Pilot of the Airwaves' Main Page](#) for links to 80s Music, Humor, and assorted historical and serious things!

---

<a href="#">GeoCities</a>	<a href="#">Rank My Site</a>	<a href="#">Take A Tour</a>	<a href="#">My Guestbook</a>	<a href="#">Chat</a>	<a href="#">Ema</a>
<input type="checkbox"/>	<a href="#">Pages Like</a>	<a href="#">Search</a>	<a href="#">Send This Page</a>	<a href="#">Forums</a>	



[Start a Group](#) - [My Groups](#)

**gccloopantennadesign** · Loop Antenna Information and Design

[ [Join This Group!](#) ]

- ▶ [Home](#)
- [Messages](#)

---

- Members Only**
- [Chat](#)
- [Files](#)
- [Photos](#)
- [Links](#)
- [Database](#)
- [Polls](#)
- [Members](#)
- [Calendar](#)
- [Promote](#)

([Already receiving group email?](#))

## Description

Category: [Shortwave](#)



Welcome the GCC Loop Antenna Designers and Builders group, this list is everyone who likes to learn about all bands ELF, VLF, LF, MF, HF, VHF, and FM broadcast and UHF Loop

antennas.

Contruccion, tips, help, questions, and websites are welcome to the group. I hope this group will help. Also ferrite Loop Antennas here too. So get out the wood, magnet wire, variable capacitors, and don't forget the electrical components, and lets start sharing some tips, and ideas,questions about loop antennas.

In addition we can also talk about the assembled loop antennas; how to use a loop antenna; and modify a loop antenna to certian requirements. Some loop antennas to consider are the Select A Tenna, TERK AM (MW) Loop Antenna, Justice AM (MW) Loop, and directional loop antennas . Ham's, SWL, monitors, DXer's, everyone is welcome that is into using a loop antenna with their radio and receiver. Our discussion is based on loop couplers, loop antennas, commercially made loops, and your homemade loop antenna creations that cover SLF to EHF.

BTW: This group will not ever shut down, we are upgrading and getting more interesting projects here as well.

Join us! Leave a Post while you are at it,also share some suggestions, antenna projects with us. 73

Be sure to learn more and get more links and groups from this membership here! <http://groups.yahoo.com/group/gccradiodxworld/> and

## Group Info

Members: **1109**

Founded: **Feb 14, 2002**

Language: **English**

## Group Settings

- Listed in directory
- Restricted membership
- Unmoderated
- All members may post
- Public archives
- Email attachments are not permitted



<http://www.geocities.com/gccengineering/> and also  
<http://www.geocities.com/gccradioscienceobserver1978/intro.html>  
<http://www.groups.yahoo.com/group/Radio-Science/>  
Be sure to check out upcoming projects, and other groups postings here, we invite everyone from all over the world to participate.

Also visit our groups here called For Your Interference Solutions from the Community <http://groups.yahoo.com/group/gccradiodx/>  
For You Interested In Making A Ferrite Rod Antenna  
<http://groups.yahoo.com/group/FerriteRodAntenna/>

## What's New

New within the last seven days:

Members: 4

[Messages: 1](#)

## Recent Messages

[View all Messages \(2514\)](#)

 [Get messages in RSS](#) |  [Add to My Yahoo!](#)

- Sep 6 [Increasing tuning range. - \*\*electronicdx\*\*](#)  
I have the old loop antenna, and I wanted to increase range with configuring th
- Aug 30 [Re: New Group - Central Electronics Collecting and Restoring - \*\*radiohighfreq\*\*](#)  
= = = In gccloopantennadesign@yahoogroups.com, ... keep getting a message that
- Aug 29 [Re: New Group - Central Electronics Collecting and Restoring - \*\*wa1yqh0\*\*](#)  
if there is a central electronics group i can not get into it ,i keep getting
- Aug 29 [correction -- to Central Electronic Collecting - \*\*joeyjeepusa\*\*](#)  
Hello everyone, I have created a new Yahoo group "Central Electronics." The gro
- Aug 29 [New Group - Central Electronics Collecting and Restoring - \*\*joeyjeepusa\*\*](#)  
Hello everyone, I have created a new Yahoo group "Central Electronics." The gro

## Message History

	Jan	Feb	Mar	Apr	May	Jun	Jul	Aug	Sep	Oct	Nov	Dec
2004	<a href="#">147</a>	<a href="#">150</a>	<a href="#">436</a>	<a href="#">138</a>	<a href="#">221</a>	<a href="#">249</a>	<a href="#">113</a>	<a href="#">43</a>	<a href="#">1</a>			
2003	<a href="#">22</a>	<a href="#">39</a>	<a href="#">44</a>	<a href="#">18</a>	<a href="#">15</a>	<a href="#">130</a>	<a href="#">77</a>	<a href="#">108</a>	<a href="#">108</a>	<a href="#">76</a>	<a href="#">70</a>	<a href="#">139</a>
2002		<a href="#">9</a>	<a href="#">1</a>	<a href="#">1</a>	<a href="#">7</a>	<a href="#">1</a>	<a href="#">5</a>	<a href="#">64</a>	<a href="#">50</a>	<a href="#">9</a>	<a href="#">6</a>	<a href="#">17</a>

## Group Email Addresses

For more information: <http://www.groups.yahoo.com/group/gccradiodxworld/>

Post message: [gccloopantennadesign@yahoogroups.com](mailto:gccloopantennadesign@yahoogroups.com)

Subscribe: [gccloopantennadesign-subscribe@yahoogroups.com](mailto:gccloopantennadesign-subscribe@yahoogroups.com)

Unsubscribe: [gccloopantennadesign-unsubscribe@yahoogroups.com](mailto:gccloopantennadesign-unsubscribe@yahoogroups.com)

List owner: [gccloopantennadesign-owner@yahoogroups.com](mailto:gccloopantennadesign-owner@yahoogroups.com)

### Yahoo! Sponsored Links

[Ham Radio Batteries on eBay](#): Find ham radio batteries at low prices. With over 5 million items for sale every day, you'll find all kinds of unique things on eBay - The World's Online Marketplace.

[www.ebay.com](http://www.ebay.com)

---

Copyright © 2004 Yahoo! Inc. All rights reserved.

[Privacy Policy](#) - [Copyright Policy](#) - [Terms of Service](#) - [Guidelines](#) - [Help](#)



**loopantennas** · Loop Antennas

[ [Join This Group!](#) ]

- ▶ [Home](#)
- [Links](#)
- [Calendar](#)

---

- Members Only**
- [Messages](#)
- [Chat](#)
- [Files](#)
- [Photos](#)
- [Database](#)
- [Polls](#)
- [Promote](#)

([Already receiving group email?](#))

## Description

Category: [Shortwave](#)

Discussion of loop antennas on all bands including ferrite loops, air core, all types. All bands SHF, VLF, LF, MF, HF, VHF, UHF, etc. Shortwave, longwave, receivers, transmitters, all fair game here.

Trying to resurrect the old LoopAntennas list without the melodrama. Please post links, files, etc. Please write a good description of files and links when you post them. I saved all the links, we'll have to build up the archives again.

All new members are moderated until you post once or twice, or if I recognize you. Spammers will be handled with minimum fuss.

## What's New

Nothing new within the last 7 days

## Message History

	Jan	Feb	Mar	Apr	May	Jun	Jul	Aug	Sep	Oct	Nov	Dec
2004						131	21	49				

## Group Email Addresses

Post message: [loopantennas@yahoogroups.com](mailto:loopantennas@yahoogroups.com)

Subscribe: [loopantennas-subscribe@yahoogroups.com](mailto:loopantennas-subscribe@yahoogroups.com)

Unsubscribe: [loopantennas-unsubscribe@yahoogroups.com](mailto:loopantennas-unsubscribe@yahoogroups.com)

List owner: [loopantennas-owner@yahoogroups.com](mailto:loopantennas-owner@yahoogroups.com)

### Yahoo! Sponsored Links

[Radio Batteries at Batteryjack](#): Deep Discount prices on Motorola, Bendix King, Kenwood, Icom, GE/Ericsson radio batteries and accessories at Batteryjack. Dealers welcome.

[www.batteryjack.com](http://www.batteryjack.com)

### Group Info

Members: **219**

Founded: **Jun 7, 2004**

Language: **English**

### Group Settings

- Listed in directory
- Open membership
- Posts from new members require approval
- All members may post
- Archives for members only
- Email attachments are permitted

---

Copyright © 2004 Yahoo! Inc. All rights reserved.

[Privacy Policy](#) - [Copyright Policy](#) - [Terms of Service](#) - [Guidelines](#) - [Help](#)

# EQUIPMENT AND PROJECTS



The following are some good emergency antenna projects to consider building. There are several reasons to consider building your own antennas for emergency work which include:

1. They are not expensive so if you loose them, or they get destroyed during the event you're not out big bucks!
2. You will gain a greater understanding of RF technologies especially antenna design.
3. You will learn how to improvise!
4. Last but not least, its fun!

Each antenna has a unique use. Please consider experimenting and playing! Share your success on the weekly nets as well!

[Build a J-Pole for any frequency - Includes an Excel Spreadsheet!](#)  
[Plans for a J-Pole](#)

[Pocket J-Pole](#)

[Half Wave J-Pole](#)

[Stacked 5/8](#)

[Field 2 meter Colinear](#)

[2 meter Colinear in PVC](#)

[2 meter Halo](#)

[Eggbeater Loop Antenna](#)

[HF Antenna Designs](#)

[Trickle Charge Circuit](#)

## Off Site Plans

[NVIS](#) Short Range Antenna Systems for HF

[NVIS](#) Discussions

[KB1DIG's](#) Home Site

[Copper Cactus Plans](#)

[N7QVC's J-Pole Plans](#)

[St. Louis Vertical](#) (10-40m)

[Windom](#) - 6 bands in one antenna

[Quickie Vertical-](#) By KQ6RH

[Wide Band Folded Dipole](#)

[Horizontally Oriented, Horizontally Polarized Large Wire Loop Antennas](#)

## Disaster Supply Kit

Being ready for an event or disaster requires preparation before the call comes. This means getting a supply kit together and knowing what is in it. We have [included a article](#) to help start your list.

Number of visitors:

067397

[n2njh@arrl.net](mailto:n2njh@arrl.net)

Buffalo, NY - USA

©Copyright 1997-2000

This page was last updated on : undefined



# How to Make the Ultimate AM Antenna

Carver Corporation of Lynnwood, Washington once made the ultimate AM Stereo/FM Stereo tuner, the Carver TX-11b. The performance of this tuner was nothing short of spectacular on FM; the AM side was even more impressive, as it was designed to have an audio bandwidth of 20 Hz - 15 KHz -- the same as broadcast FM!

In order to receive clear AM Stereo signals -- on the TX-11b or any other AM radio, however, you have to have a good antenna. So Carver gave a plan for making what they called "The Ultimate AM Antenna." Here are the plans for this antenna.

1. Construct a wood frame that measures 12 inches from point to point (17 inches across each bar).
2. Secure the frame to a base.
3. Wrap the frame with four turns of #22 insulated solid wire.
4. Twist the wire ends together approximately 2 turns per inch (I made a change here. On the base, I installed a two-wire terminal so I could easily connect a different length lead wire. I connected the ends of the wire from the loop to the terminal block and then connected a shielded wire to the terminal block to act as a lead-in. The ground (shield) lead connects to the ground terminal of the radio, the center wire connects to the "external AM antenna" terminal of the radio. You may have to experiment with your own radio to find what works best).
5. Strip wire ends and connect to the AM terminals on the back of the radio (unless you used my changed design in 4 above).

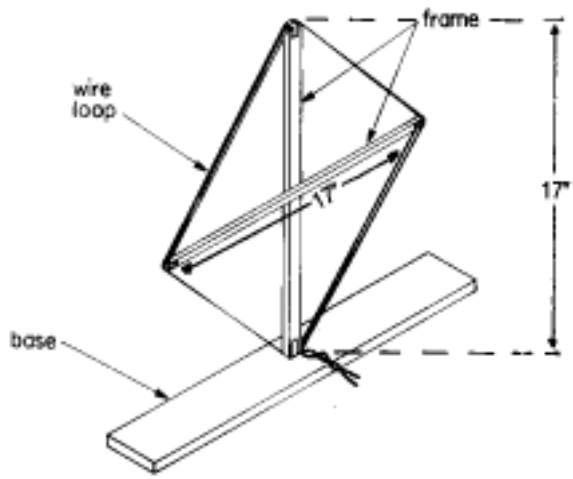

The idea is that the size of the antenna acts as a long wire antenna, but the loop acts as a local noise eliminator. I have found it to work quite well in the Los Angeles area, where at night I can often pick up very distant stations with ease.

Other ideas you may try are simple long wire antennas (good for distance or eliminating long-distance atmospheric noises) or if you are in an office that doesn't like the look of the "ultimate antenna," just placing a portable radio near a window.



# Doug's Radio-Electronics Loop Antenna Page

---

Part 5 of a series on antennas appears in Radio-Electronics Magazine for June, 1983 on page 83. Its title is "All About Loop Antennas for VLF-LF."

I'll reproduce the text, but there are several illustrations that I can't duplicate. It would be worthwhile to find yourself a complete copy of the article. My copy is pretty poor and I can't even tell what's in many of the figures!

Added December, 2001 - I have recently found a better copy of this article and scanned it, complete with separate scans of the graphics. Go back to the [Short Wave Radio Page](#) and look for the link.

---

Perhaps the most important difference between loop antennas and the whip antennas that we have previously discussed is the loop's directivity. (The vertical whip is, of course, omni-directional and cannot indicate the direction from which a received wave comes.) Before we can talk more about this directive property, we have to take a look at how an electrical signal is induced in the loop by a passing electromagnetic wave, and at some general electrical characteristics of loop antennas.

## Loop antenna characteristics

A current is set up in a loop antenna by a changing magnetic field. (That current is equal to the integral of the electric field that is induced around the loop.) The sensitivity of a loop is directly proportional to the loop area and to the number of turns in the loop. It is, in general, inversely proportional to the wavelength of the signal. Small receiving loops for 60 kHz (WWVB) require a preamplifier with a voltage gain of 30 dB or more to make them comparable in performance to a small active whip antenna. [Ed. Note: notice the key word '**active**' here!]

The inductance of the loop winding itself makes loop antennas frequency-sensitive. Because of that, it becomes difficult to make such antennas with wide-band characteristics. To increase the sensitivity of a loop, multiple-turn coils are used at the VLF-LF range. However, the distributed capacitance of the windings acts with the loop's inductance to decrease the antenna's frequency response. That however, is not always a disadvantage. The frequency selectivity of a loop winding is often an advantage in that it can provide for rejection of out-of-band signals (in other words, it can form a sharply tunable antenna system). Loop antenna systems seldom have intermodulation-distortion problems because of their lower sensitivity, lower impedance level, and better selectivity.

## Directivity of loops

Perhaps the most significant and valuable property of loop antennas is the fact that they can be used to determine the direction of an arriving signal. Let's look at how they can do that. Consider a loop and a vertically polarized passing electromagnetic wave as shown in Fig. 1-a. {**SORRY!**} A voltage will be induced in the vertical members of the loop, but none in the horizontal ones. If the voltages induced in each vertical member are the same (as they would be if the plane of the loop were perpendicular to the direction of travel, Z, as shown), then no current will flow. [editor's note: the advancing wave front hits the entire loop broadside, all at the same time, so there is no conductor cutting a magnetic line of force.] However, if the plane of the loop is parallel to the direction of travel of the oncoming wave, as shown in Fig. 1-b, then the wave will reach one side of the loop before the other, the total voltage around the loop will not be zero, and current will flow. [**transformer action!**] The voltage induced in the vertical members is proportional to the height of the loop, and voltage difference between the vertical members is proportional to the width of the loop. Therefore, the voltage around the entire loop is proportional to the product of its height and the width - that is, its area.

Another way of reaching the same conclusion is to say that the voltage induced around the loop is proportional to the rate of change of the magnetic-flux linkages through the loop. Then it is obvious that the area of the loop is the controlling factor, and the loop will receive the most signal when its plane is normal (perpendicular) to the magnetic field (H) of the oncoming wave (or in the same plane as the direction of travel of the oncoming wave).

## Direction-finding shortcomings

The directional properties of loop antennas that we have just described permit you to null out interference or to obtain a broad peaking of a signal merely by rotating the loop. However, loops, though they are often used because of their relative simplicity, are not ideal direction-finding antennas.

Loops cannot distinguish between signals that arrive from opposite directions (for example, north and south). Another drawback is that trying to determine the source of a signal that arrives at an angle different from that of the ground wave (not exactly head-on) will usually result in an error. Ground waves themselves frequently arrive "tilted." That tilting is often due to the magnetic effects of such things as the steel I-beams of buildings (which distort the boundary conditions even for close-in ground wave reception). One way that the problems caused by downcoming ("tilted") waves can be reduced is by using an *Adcock* antenna. We won't discuss that antenna in any detail except to say that it operates by canceling out voltages induced in its horizontal members. A third problem that loop antennas have in direction-finding applications, especially at low frequencies, is due to the *antenna effect*. The antenna effect is seen when a direction-finding antenna acts like a simple, non-directional one. Loop antennas, when used at low frequencies, are subject to that effect because their size is only a fraction of a wavelength, and they pick up interference from a signal derived from the electric, rather than the magnetic, field. A loop's symmetry should ideally cause that signal to be cancelled out, but in real

systems the effect is often the source of problems.

## Resolving those problems

If you were to turn a loop antenna through 360 degrees and observe the strength of the signal received, you would obtain a reception pattern that looked like a figure-8. Such a pattern leaves you with a 180 degree uncertainty as to which direction the signal is from. That uncertainty can be resolved by using a whip antenna in conjunction with the loop to cancel one of lobes of the figure-8 pattern. That is done by coupling the output of the vertical antenna to the loop so that the voltage induced in the loop by the coupling is 90 degrees out of phase with the voltage the passing wave induces in the vertical antenna. Figure 2 [*in the magazine only*] shows the cardioid directional pattern that results from combining the figure-8 with the omnidirectional pattern from a whip. The sense of the incoming signal is usually determined by rotating the loop to cancel one of the lobes of the figure-8. In practical systems it is necessary to provide some phase- and amplitude-balancing between the two antennas.

To reduce the antenna effect that distorts the loop's directional pattern, and to obtain the best performance (in terms of detecting sharp nulls and uniform amplitude-peaks as the loop is rotated), the loop should be mounted within an *electrostatic shield*. That arrangement balances the loop by making sure that all parts of it will have the same capacitance to ground. That shield or cavity also protects the loop from the *induction field* created by nearby disturbances. The induction field refers to the electric and magnetic fields in the immediate vicinity of an antenna. Those fields decrease rapidly in strength with distance, and the induction field is usually ignored (and the *radiation field* is all that is considered). However, wires and other metal objects near the loop can take energy from a passing wave and produce induction (and radiation) fields that can induce spurious voltages in the loop.

A shield over a loop antenna (one type of shielded loop is shown in Fig. 3 [*but not here!*] ) will not appreciably decrease the amount of magnetic flux that passes through (and links with) the loop when a wave goes by - as long as it does not form a complete (shorted to itself) turn. An insulated segment or gap is always left in the shield so that it does not become a shorted turn. Without the gap, the shield would form a shorted turn and it would reduce the magnetic field linking the loop so that no signal could be received by the internal wire(s). With the insulated segment or air gap, alternating currents can be induced in the metal shield (but no current will flow), and voltages will be induced in the internal wire(s). Some experimenters have wound loops inside slit *Hula-Hoops* and then shielded them by wrapping the outside with aluminum tape, leaving a gap in the tape at the top of the loop. Ferrite-core loops (which we will discuss shortly) are usually mounted axially in a trough or U-shaped channel (with the top and ends open to prevent a shorted turn) for electrostatic shielding.

A method for making a square box-frame loop is shown in Fig. 4 [*sorry again*]. A long length of U-channel is formed into a box frame by cutting slots into the side of the channel and then bending the material. [*The bottom of the U is toward the inside of the box. The slots are cut in the "upright" arms of the U.*] A small gap with a plastic insulator in it is left at the top of the frame; the insulator holds it together and prevents it from forming a shorted loop. The coil winding is supported on plastic foam, just

below the outer edges of the U-channel.

## Winding loops

The distributed capacitance of the loop may, especially at low frequencies, cause the current to vary at different points on the loop and cause deviations in the directional pattern. A technique for reducing the distributed capacitance of the loop windings is to make the loop in a *mobius* form. A mobius loop is one where the coil is "twisted" so that (except at the start/finish point where the wires cross) all the "even-numbered" turns are adjacent to one another, with the same being true for the "odd-numbered" turns. The distributed capacitance of the mobius-type antenna shown in Fig. 5 is about one-half that of the antenna illustrated in Fig. 4 - even though both contain the same number of turns. The mobius-wound antenna also has a wider bandwidth.

## Effective length

When we discussed active-antenna systems [*in a prior article in the series, and which I don't have*], we frequently mentioned the *effective length* of an antenna (often referred to as *effective height*). We can also talk about the effective vertical length of a loop antenna. An approximation for computing the effective length, *LL*, of loop antennas is

$$LL = (2 * \pi * n * A * \text{Mu}) / (\text{wavelength}) \text{ [Eq. 1]}$$

Where wavelength is in meters; n = the number of turns in the loop; A = the cross-sectional area of one turn in square meters; Mu = the effective permeability of the core material ( = 1 for air core); and wavelength =  $(3 * (10^{**8})) / (\text{frequency in Hz})$ . [*That's wavelength = three times ten to the eighth power, then divided by frequency.*]

## Small-size ferrite-core loop antennas

It is often useful to consider the smallest practical size of loop antenna that can be used, say for reception of signals such as those from WWVB at 60 kHz. Using a ferrite core increases the effective permeability of the core and, as you can see from equation 1, that increases the effective length. Ferrite cores are available commercially in several different permeability ranges. Figure 6 is a chart that illustrates the effective permeability of a ferrite rod compared to the bulk permeability of the ferrite material.

The whole idea of using a ferrite-rod core is to increase the magnetic flux density through the loop. For the maximum effect, you want to have as much of the core exposed to the winding as possible. Compact, multiple-layer coils in the center of a long core-rod are never as sensitive as a single-layer coil that covers almost the whole length of the rod. Unfortunately a long coil has a problem in that the distributed capacitance of the coil winding is quite high, and the Q of the long coil will not be as good as a coil with a better "shape factor" (smaller length-to-diameter ratio). To maximize the coil's sensitivity to the magnetic field in space, the product of the number of turns and effective permeability of the rod should

be as large a number as possible. From Fig. 6 it can be seen that the whole length of the rod should be used to maximize the effective permeability. Another factor to consider is the effect that the ferrite material used has on the Q of the coil. (At low frequencies, the maximum Q that can be obtained depends on the core material, its size, and the signal frequency.) Figure 7 describes the effect on Q for an 800 Mu bulk-ferrite-material rod that measures 1/2 x 7 x 1/2 inches. It also describes the antenna's response with and without external capacitances added. The winding properties of the ferrite-core loop are included in Table 1, and [Fig. 8](#) shows the ferrite-core loop-antenna itself.

## Comparing loops

The comparative properties of a ferrite-rod antenna and the two air core box frame loops (shown in Figs. 4 and 5) are shown in Table 1. The scramble-wound box loop, which is in a slightly smaller U-channel, has a higher winding capacitance that results in a resonant frequency of 180 kHz. The mobius flat-wound loop has only half the winding capacitance and almost the same inductance. That results in a higher resonant frequency of 275 kHz. Both of the air-core box loops are intended to be operated in the wideband mode with no external tuning-capacitance. *[editor's note: this is the only place I've seen this "no tuning capacitor wideband mode" mentioned.]* The mobius box-frame loop has exceptionally deep nulls of 40 dB or more in the 60-kHz to 100-kHz frequency range. The ferrite-rod loop is intended for fixed-frequency use (tuned to 60 kHz with an external tuning capacitor) for WWVB reception. Similar ferrite loops (where the loop coil and housing is different for each frequency band) that cover a wider frequency range are available commercially from several sources.

For an untuned box-loop, the upper-frequency limit is determined by the self-resonant frequency of the coil and its distributed capacitance. The effective length is greatest at that point, and it decreases by a factor of 10 or so at the 10-kHz low-frequency end. The box loop can also be tuned by placing a tuning capacitor in parallel with the loop coil. That will increase the Q, but a preamplifier with a higher input impedance will be required. The best power transfer from the loop coil to the preamplifier is usually obtained when the loop impedance and the preamplifier input impedance are in the same range - which is not at highest Q. In designing loop antennas there is always a compromise to make between selectivity and sensitivity. An untuned loop with a rather broad self-resonant frequency peak (which is the case for the flat mobius-coil box-loop) provides the best sensitivity and also the deepest nulls of the antennas compared in Table 1.

## Balanced Loops

As we discussed previously, to obtain the best null performance, loop antennas should be operated so that the capacitance between the antenna and electrostatic shield is the same at all points along the loop. With a single winding that's a problem, since one end of the winding has to be grounded in some way. A loop with a center-tapped winding is often used together with a preamp with a balanced input, but there is a better way of winding loops on long ferrite rods that also reduces the inductance of the whole winding and results in a single-ended termination for the loop.

The technique developed by the U.S. Army Signal Corps many years ago, involves making right-hand and left-hand-sense windings starting at the center of core. The resulting loop, shown in [Fig. 9\\*](#), still has opposite-phase nulls off opposite ends, but now has excellent electrostatic symmetry with respect to the trough shield. (The ferrite core loop discussed earlier was a balanced loop.) The sensitivity of this coil is about the same as that of a coil wound in a single direction from one end to the other, but the inductance is reduced, resulting in a higher self-resonant frequency. The termination point in the center of the core practically eliminates induction-field noise pickup, even with a single-ended preamplifier system. When winding a coil with a relatively large number of turns, it is advisable to check the winding for inductive balance because the ferrite core material may not be uniform from end to end. Another factor contributing to non-uniformity is that it is difficult to wind a perfectly spaced coil by hand. That is why the figures indicating the number of turns on each side of the antenna described in Table 1 are different.

To tune the balanced loop coil arrangement shown in [Fig. 9\\*](#) to resonance at 60 kHz, a fixed capacitor of about 500 pF can be placed in parallel with a small variable capacitor of up to 350 pF (and the 330 pF distributed capacitance of the coils). That allows the total capacitance to be set to about 1000 pF - the capacitance required for resonance with the 6.89 mH inductance indicated in Fig. 7.

## Balun method

Another technique for making the capacitance of a single-winding loop symmetric with respect to the electrostatic shielding is to employ a toroidal balun (BALanced-line to UNbalanced line) transformer between the loop winding and the preamplifier. That technique is illustrated in [Fig. 10](#). The balun is used with the air core box loops shown in Fig. 4, which have no center tap on the loop windings. The trifilar-wound transformer consists of about 30 turns of No. 30 insulated wire-wrap wire twisted 6 to 8 turns-per-inch and wound on an Amidon (12033 Otsego St., North Hollywood, CA 91607 [[www.amidon.com](http://www.amidon.com) I think] FT82-75 high-permeability ferrite core. That makes the loop coil, which is a balanced source, look like an unbalanced source to the preamplifier. Baluns can also be used with ferrite core antennas wound in a single direction (instead of the right-left method of [Fig. 9](#)).

## Loop antenna locations

Loop antennas are much less sensitive than small whips, but they have the advantage of having more selectivity as well as having directional null- and peaking- properties. It's a good idea to place a loop in the attic of a house well away from the electrical appliances and power lines, and to keep it away from major steel structural members (which distort the local magnetic field).

## High-gain preamplifier

When designing an active whip antenna, we considered the whip to be a voltage source with a high internal impedance requiring current amplification, and (to reduce attenuation due to a mismatch) we wanted the preamplifier also to have a high input impedance. However, with a loop antenna, which is considered to be a low-impedance current source, we want a low impedance voltage amplifier.

Almost all LF loop antennas will require a preamplifier with a voltage gain on the order of +30 dB. Low-noise performance is more important here than with whip antenna preamps because of the lower signal levels at the loop terminals. There is a great variety of circuits possible, but one of the simplest uses a power-FET or VMOS-FET like the one shown in [Fig. 11](#). That preamp should be mounted directly at the terminals of the loop in a weatherproof shielded box or inside of a trough shield (with the balun transformer, if required). The output of the amplifier is fed (through a coaxial cable) back to the same receiver coupler that we used with the active antennas described in previous articles. The gate bias voltage divider trimmer potentiometer is adjusted so that the operating current of the receiver coupler is about 40 mA. The VMOS transistor used can be the Siliconix VN10KM. You can also use an ITT BS170 - which has properties similar to those of the VN10KM, but a different pinout. The series resistor for the gate bias, about 15,000 ohms, is chosen to approximately equal the reactance of the loop coil at the highest or cutoff operating frequency. If a tuned loop coil with higher Q is used, then the value of the resistor should be increased in value to 100,000 ohms or so. The output transformer can be the primary winding (about 200 or 600 ohms) of a subminiature or ultraminiature audio transformer. The secondary can be left open for operation up to the 500 kHz region. At higher frequencies a bifilar toroid - such as the one wound on an Amidon FT50-75 core for the wideband active whip preamplifier - can be used as an output transformer. The preamplifier will have a voltage gain of about 30 dB when driving a 50 ohm load at the receiver coupler.

## Bench testing loops

You can evaluate the resonant frequency of a small loop antenna system by connecting a coupling coil and a 50 ohm load resistor in parallel as a termination at the end of a coaxial cable from a signal generator. For low frequency testing (below 500 kHz) the coil can be a 1-mH pi-wound RF choke. The probe is brought very close to the loop under test to inject a small amount of signal by magnetic or inductive coupling. The output from the loop and/or a suitable preamplifier are then observed (either on an oscilloscope or a receiver) as the signal generator is tuned over the desired frequency range. The coupling sensitivity of both the probe coil and the loop will decrease at lower frequencies. This simple magnetic probe will allow you to obtain a good idea of the loop resonance and its general performance. You can also estimate the loop inductance by placing known capacitors in parallel with the antenna and then observing the response. The coil's distributed capacitance can be estimated by computing the difference between the resonant frequencies of the loop with and without the added tuning capacitance.

*\* for Fig. 9, take the piece of wire to wind the loop with and fold it in half. Lay the wire on a table in a long, narrow V layout. Set the rod core on top of the wire close to the apex of the V and put a dab of glue there to hold it. Then roll the rod along the wire so that the wire winds up around the rod and expands the coil toward both ends at the same time. That's the bidirectional coil shown in [Fig. 9](#).*

**[Note: I hope that MS Word's spell checker caught all of my multitudinous typing errors! If not, SORRY!]**

-----[home](#) ----- updated October 12, 1999 & December 16, 2001

---



## AN EASY VLF LOOP

### 200Hz-20kHz reception without transformers

by Renato Romero and Marco Bruno

A warm afternoon, in a summer day of this year, I was yellow painting an old hula-hop. My wife looked at me, saying "What are you doing?". "I'm yellow painting a hoola-hop" I answered. My wife replied: "I see, but why are you painting ... oh my God! Another antenna!"

"Yes, but this antenna is different from the other ones". And she, laughing: "I see, it is yellow(\*)". I explained: "With this kind of antenna I can receive signals that are not received with the others one". And she: "It does mean you will put all the other antennas away?" "Not exactly ..." I answered.

But my wife is right: there are antennas at every corner in my garden. Well, this antenna will not solve your family problems, but it can give some advantages in VLF reception, in comparison to the Electric field receivers like RS4; especially when the noise conditions are not very good, like in the city or near the house. The preamplifier of this antenna is very easy to build.

(\*) we have a new theory, on antenna colour affecting radio performance, especially in foggy environments ;-)

---

## WHY ANOTHER LOOP PROJECT

The original small loop project started some year ago, in 1995. The electric circuit is reported in "RECEPTION TECHNIQUES / Active an passive system" on this web site. It was a good project and a copy of this receiver has been used also by the "Astronomical Association of Umbria" to study the correlation between VLF and Meteor events. But its construction can give some problems: the loop antenna is easy to build but the preamplifier has a lot of active components (many gain stages, much noise). Some people asked me how to find the input transformer: I used an old impedance transformer, taken by an old Phonola tube radio; but where to buy other similar components?

Dave Ewer helped me with his loop amplifier project, as described in "RECEPTION TECHNIQUES / Mobile stereo NATURAL RADIO 2". His project, based on mine, gives better results in term of S/N ratio. Dave in his project uses only standard components, like a Mauser device as transformer.

The project here presented was based on ideas by Marco IK1ODO, and doesn't uses any transformer. The loop is connected to the preamplifier circuit directly and the circuit contains only one active component.

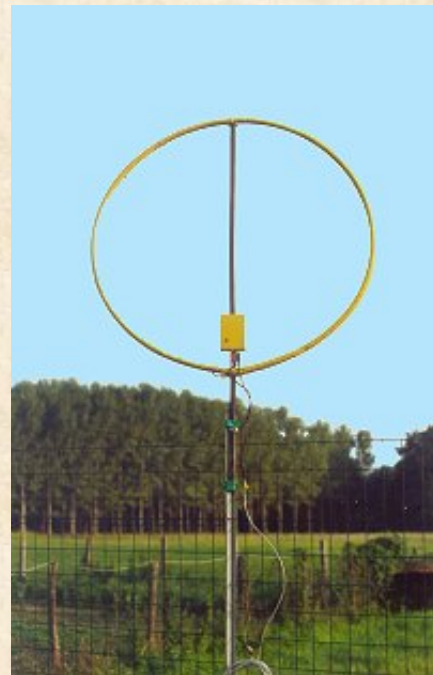

The signal output can be connected directly to the LINE input of the Sound Blaster card, or LINE input of a tape recorder.

---

## THE LOOP PROJECT

The choice of loop dimensions must take two factors in account: to have an antenna big enough to be sensitive and small enough to be transported or installed on a balcony without disturbing too much the view. The choice of the support fell again on a plastic hula hop because of the economy in materials, conserving a clean look. Dimensions and turns number have been calculated with Rjeloop3.exe by G4FGQ.

```

L Length of one side of square frame, mm .... 660
N Number of turns of wire on the frame ..... 40
D Diameter of wire, milli-metres ..... 0.6
R Ratio of (winding pitch)/(wire diameter) .. 1.05
F Frequency, kilo-hertz ..... 2
M(Messages) toggles
this window on & off
only when it can be
seen on bottom line.

Inductance ..... 3181.2 micro-henrys
Inductive reactance ..... 40 ohms
HF loss resistance of wire . 7.44 ohms
Radiation loss resistance .. 0.00 milli-ohms
Self-resonant frequency .... 0.6 mega-hertz, approximately

Total capacitance required . 1990594 pico-farads for resonance
deduct stray capacitance 20 .. ..
Setting of tuning capacitor. 1990574 .. .. ..
Approximate coil Q ..... 5
Receiving sensitivity ..... 146 decibels below 1/4-wave vertical

Width of winding ..... 25.2 milli-metres
Total length of wire ..... 105.60 metres

Impedance seen across loop . 0.2 K-ohms, when tuned to resonance
Impedance seen by Receiver . 0.0 K-ohms, via 1-turn coupling loop

L,N,D,R or F to change value, C(lear), B(ack), M(essages) or Q(uit) ..
    
```

The program works assuming a square loop, while the hula hop is round, so a square has been calculated with the same area, resulting in a side of about 66 cm. The loop has 40 turns of copper wire of 0.6 mm<sup>2</sup> section for a total of 106 m and a resulting inductance value of 3.2 mH.

Mechanical details are not given here since we are talking about a simple shielded coil in air. The hula-hop tube was cut on the outer rim to allow the insertion of the wire, one turn at a time. The shield is made from aluminum foil wrapped around the whole loop, except for 10 cm in its superior part where the shield is interrupted. Everything was covered with adhesive PVC tape to protect from bad weather and painted with a protective enamel. The shield is not indispensable (see later), during all trials I haven't seen any difference between the antenna with shield and without it. The final result is shown in picture and is esthetically very similar to the RCM preceding model.

## THE CIRCUIT

The circuit uses a low-noise and stable op-amp, the well known OP27.

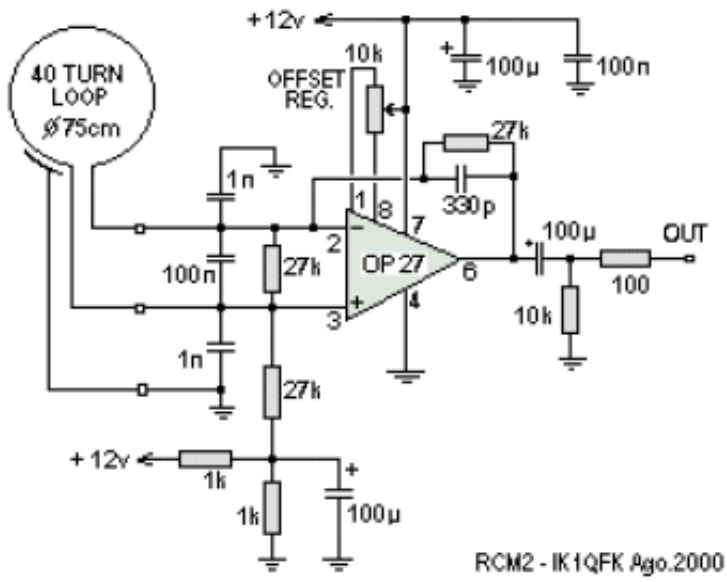

EASYLOOP, Electric scheme

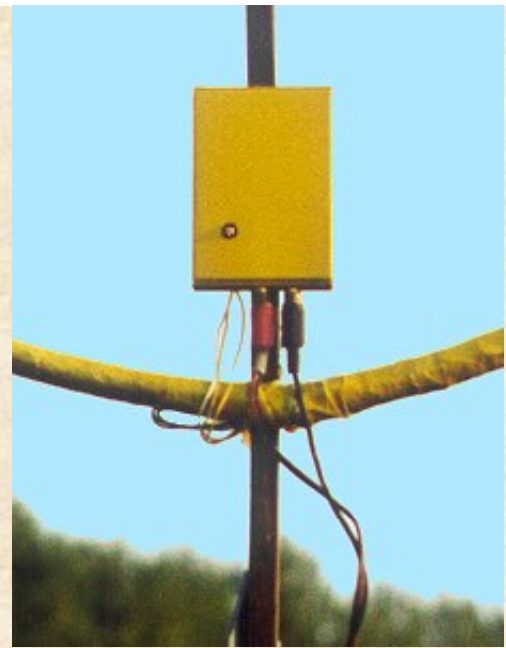

Compared with other common devices like the TL081 or  $\mu$ A741, this opamp has interesting characteristics. The intrinsic noise voltage is very low at  $3\text{nV}/\sqrt{\text{Hz}}$ , to be compared with  $18\text{nV}/\sqrt{\text{Hz}}$  for the quiet TL081 or  $90\text{nV}/\sqrt{\text{Hz}}$  for the  $\mu$ A741! To improve this value you need special and sophisticated circuits. The input noise current is also very low, so you may use it on very low impedances like loops. An impedance step-up transformer is simply not needed.

The circuit is simple, being derived from the configuration used with low-impedance dynamic microphones. There is an important difference between this circuit and other seen previously: the loop is terminated in a zero impedance (the virtual ground at the input of the op-amp). So, the useful signal is the current developed in the loop; other designs use the voltage developed on the loop, which is terminated on a high impedance. Using a low-Z amplifier allows operation to low frequency using small loops, and the sensitivity is very good.

The overall DC voltage gain is determined by the ratio between the 27k negative feedback resistor (pins 2-6) and the DC resistance of the loop (few ohm). It has to be determined experimentally if you decide to alter the number of turns, or the size of wire, to achieve DC stability and sufficient gain.

Input capacitors and the 330pF one limit the frequency response of this loop to about 22 kHz, and stop MF and HF interferences.

The 27k resistor between pins 2 and 3 acts only in case of disconnection of the loop; it may be omitted. The 10k resistor at the output limits "pops" when connecting the output of the preamplifier to the SB input; it could also be omitted.

The circuit is powered by a single supply between 12 and 24V, and requires a single adjustment for the offset voltage.

With the loop connected to the preamplifier apply power and turn the 10k potentiometer (ideally, a 10-turn device) to have exactly half the power supply voltage between pin 6 and ground. Allow some minutes for thermal stabilization of the IC.

The OP27 is not a consumer product, but is available from distribution chains like RS or Distrelec in Europe, Jameco or Radio Shack in the USA. The price is about \$2.

Being the whole loop a low impedance device closed into a short circuit, and taking in account the common mode rejection ratio of the op-amp, the shielding is not necessary. A good shield, with a low impedance path against ground, and a metallic box for the preamplifier will contribute to the long life of the IC. In any case install it on a socket, and buy more than one... we purposely included no protections for the IC in this project.

## SOME MEASUREMENTS

Some measurements on the circuit in my implementation:

FREQUENCY (Hz)	LOOP IMPEDANCE (Ohm)	GAIN (Vo/Vi)	GAIN dB
16	0,3	168947	105
30	0,6	90105	99
60	1,2	45053	93
125	2,5	21625	87
250	5,0	10813	81
500	10,0	5406	75
1000	20,0	2703	69
2000	40,0	1352	63
4000	79,9	676	57
8000	159,8	338	51
16000	319,6	169	45

The voltage gain decreases with F, compensating the increasing loop sensitivity. The output signal is constant respect to F, and is only function of the H vector flow thru the loop. More later ... see section 2 (to be published) for a more theoretical treatment of the loop frequency response.

In our case, the DC loop resistance is about 8 Ohm. The loop has an impedance of 8+j8 Ohm at 300 Hz; this is the low frequency corner of the system. Under this frequency the loop resistance prevails over the reactance, and we have a 6dB/octave rolloff in the output signal.

Increasing the wire section allows going to lower cutoff frequencies; the limit is the input noise of the OP27. In section 2 we will demonstrate that the low frequency corner is only determined by the WEIGHT of the copper used, and not by the number of turns! (please don't start buying shares of copper mines ... I already bought everything with the VLF community in mind).

## THE RESULTS

The quality of a design should be evaluated looking at the results. The EASYLOOP is compared here with a large Marconi "tee" antenna, giving the best results in VLF/ELF in my installation. In the following spectrogram statics, line harmonics and tweaks are visible. The E field antenna has more statics, and the loop is less sensitive under 1.5 kHz. Tweaks are stronger and cleaner with the loop; anyway, the results are very similar, but the area occupied by the loop is about 500 times smaller.

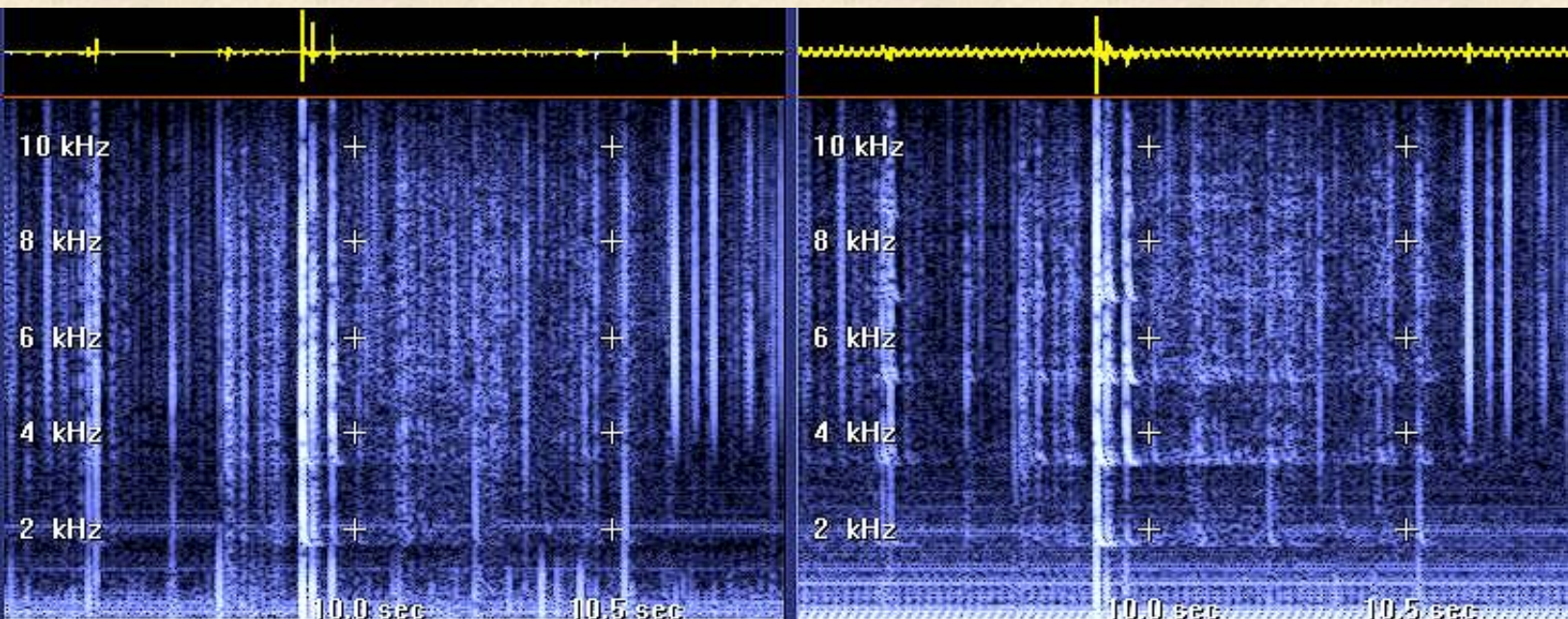

The same signal, received by Marconi T antenna (11m high with 45m top) compared with the easyloop.

The following spectrogram covers the full 22 kHz band allowed by the SoundBlaster. Here also the results are very similar, and the RTTY signal around 18-20 khz are loud and clear. The russian Alpha signals are even cleaner, with less statics.

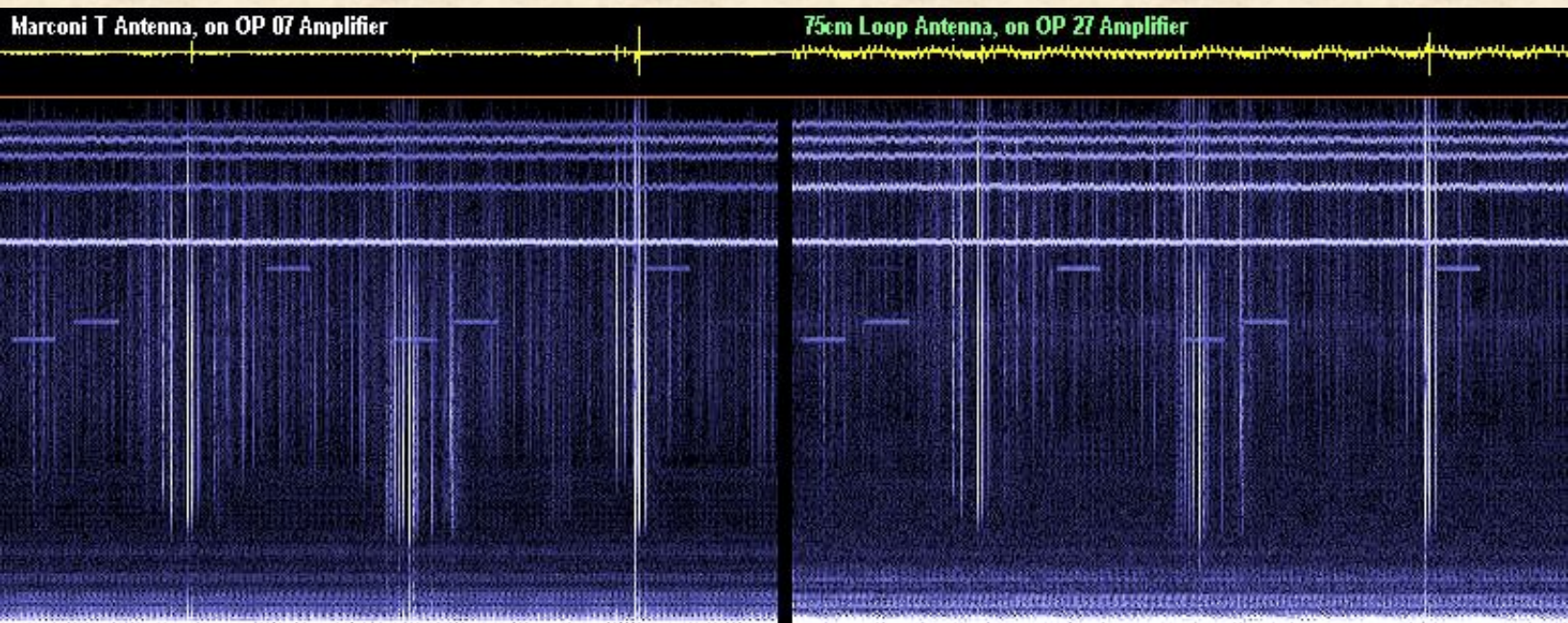

The loop was oriented for best power line noise rejection, and positioned at the base of the Marconi vertical antenna, to have similar noise conditions.

## CONCLUSIONS

A simple, but in our opinion innovative, small loop antenna for VLF/ELF has been described. The design is open to experiments and improvements, and your suggestions are welcome.

"Nihil sub sole novi" (nothing new under the sun, say the Latins), but the simplicity of this design in relation to results makes this project an interesting one. In urban noisy areas you may turn the loop to minimize interference, and this resource is very useful. The great simplicity of the preamplifier circuit, built without hard-to-find transformers, is ideal for home building.

The loop is a low impedance device, is floating respect to ground, and may be powered via long wires without compromising the performance.

(© Horrible English translation and circuit theory by Marco IK1ODO; building and experimentation by Renato IK1QFK)

[Return to the main Index](#)

# AMANDX PRESENTS



## AN UNAMPLIFIED THREE OR FOUR FOOT BOX LOOP



Below you will find plans to build a three or four foot box loop for the AM broadcast band. The loop will tune from 530 to 1710 kHz covering the whole band including the new expanded band .

This loop design was first produced by Don Moman back in the early 1980's and has proven to be a good solid design. The main advantage of this loop's design is that it uses almost no metal. This allows the loop to keep its pattern and increases the loop's ability to null stations.

The loop is Based on Don Moman's famous loop his drawing is at the bottom of the page.

The instructions below are for a four foot loop. If you do not have room for such a large loop all you have to change is:

The two cross arms should be 33.5 inches in length not 45.5 inches.

I have included drawings as well as pictures of my four foot loop at the end of the article.

These should help you visualize the loop as you build it.

### PARTS:

1- Variable capacitor of 0-365 pf, You can often find these in old AM radios that can be found at flea markets or garage sales or on eBay at [www.ebay.com](http://www.ebay.com). or KW TUBES at <http://kwtubes.s5.com/> or at Midnight Science at <http://www.midnightscience.com/>

1- Knob for the tuning capacitor. You can use a vernier knob for finer tuning.

175 feet of wire.. 20 gauge coated/insulated works well. The wire can be solid or stranded.

4- Pieces of 2 x 2 cedar cut 7 inches long These will be the end pieces.

2- Pieces of 2 x 2 cedar 45.5 inches long (33.5 inches for the 3 foot loop). These will be the cross arms.

2- Pieces of 1 x 2 cedar 6 inches long. These will be the braces to tilt the loop.

1- 1.5 inch diameter wood dowel 36 to 40 inches long. This will be the mast.

1- Piece of 2 x 1 cedar 6 inches long. This will allow you to mount the tuning capacitor

1- Piece of 2 x 2 cedar 4 inches long. This will be a brace support.

1- Outdoor plastic umbrella stand and a piece of PVC pipe to fit the mast into it. The stand should be filled with sand to give it weight to balance the antenna. The pipe should be about 12-15 inches long. You may substitute another stand but try to insure it has as little metal as possible. To much metal will distort or decrease your nulls.

1- Wire connector to connect the wires.

2- Bolts with nuts 3.5 inches long

4- Wood screws 1.5 to 2 inches long

1- Length of coax to feed antenna to the radio. Keep as short as you can but remember that the loop must still be able to tilt and rotate.

#### PREPARATION OF THE PARTS.

I used 2 x 2 and 2 x 1 cedar to build the loop but you may wish to substitute the type of wood with another variety. Just make sure it is a strong wood with few knots.

### CROSS ARMS

To form the cross arms find the center of the 45.5 inch pieces of 2 x 2. Measure  $\frac{3}{4}$  of an inch on either side of center. Shade this area in. Cut out the shaded area as shown in Figure C. Cut out the shaded area to a depth of  $\frac{3}{4}$  of an inch. This will form a notch on each arm that will allow you to fit the arms together to form an X.

### END PIECES

Take each of the 7 inch long pieces of 2 x 2 and line them upside by side.. Mark off a line across all of the pieces every half an inch. This should give you 13 lines spaced one half an inch apart across all four end pieces. You then will have to cut a groove about  $\frac{1}{4}$  of an inch deep in each line. This will give you 13 grooves on each end piece as shown in Figure A. Once that is done turn all the pieces over to the other side that has not been grooved. You will have to make a notch cut similar to the one cut on the cross arms. Find the center of each end piece and again measure  $\frac{3}{4}$  of an inch from center. Shade in this area as shown in figure B. Cut out a notch in the shaded area to a depth of about  $\frac{1}{4}$  of an inch deep. This will form a notch that will fit to the ends of the cross arms. You must do this to all four end pieces and try to be as accurate as possible to insure a balanced fit.

### BRACES

To form the braces as shown in Figure E drill two holes on the flat side of the 6 inch 2 x 1 wooden pieces. Each hole should be centered one inch from the end of the wooden piece. The size of the hole should allow the bolts you are using to slide through as tight as possible.

### DOWEL STAND

Figure F shows the 36 to 45 inch long 1.5 inch diameter dowel and the 4 inch long piece of 2 x 2 assembled. To make these two pieces fit you must cut a notch into the dowel. Cut a 4



inch long «  
inch deep notch out of the end of the dowel. The 4 inch long 2 x 2 will sit on this notch to form a support for the cross arms. Drill a hole centered about 1 to 1.5 inches from the top of the 2 x 2 piece. The hole should match the bolt you are using.

#### ASSEMBLY

##### DOWEL STAND

As shown in Figure F Take the 4 inch long 2 x 2 piece and fit it into the notch on the dowel with the hole on top. Once you are sure of a good fit glue the two pieces together with a good wood glue. You could use a screw but it is not necessary. This dowel stand will now fit into the umbrella stand and should rotate easily.

##### TUNING BOARD

Take the 6 inch long piece of 1 x 2 as shown in Figure D and mount your wire connector 1 to 2 inches from the end of the board. On the under side of the board mount the tuning capacitor at the opposite end of the board. Keep the capacitor close to the front of the board with enough clearance to attach the knob. You can use a glue or double sided tape to mount the capacitor.

##### END PIECES

Attach each of the four end pieces to the ends of the cross arms. First of all fit the cross arms together to form an X shape. You can use some wood glue to keep them together. You can attach each end piece using glue and you can put a 1 to 1.5 inch long wood screw into the center of each piece so it will be secured to the end of the arm. This is shown in Figure D.

##### MOUNTING THE TUNING BOARD

As shown in Figures G and D mount the tuning board on the top side of any of the end pieces.

The Top will be the side with no grooves on it. This will now be the bottom of the

loop as shown  
in Figure G.

#### MOUNTING THE BRACES

Take one of the bolts and put it through one brace as in Figure E then through the piece of 2 x 2 attached to the dowel as shown in Figure F and finally through the second brace. Secure the bolt using the nut (I used a wing nut to make it easier). You now have a stand with a rotating and tilting mechanism. This can be placed into the umbrella stand as in Figure G.

#### MOUNTING THE LOOP

Slide the loop between the two braces and see where it would balance for tilting and rotating with out hitting anything such as lights in the ceiling. I drilled a hole 17 inches from the center of the loop on the bottom arm with the tuning unit attached to it. You can slide the second bolt through a brace then through the hole in the cross arm and then through the second brace. Secure the loop bolt with a nut as you had done with the first bolt as shown in Figure G.

#### PICK UP LOOP

In order to install a pick loop of wire into the assembled loop you must drill a hole 3.5 inches from the tip of the loop arm in each arm. The hole need only be big enough to feed you wire through. The pick up loop of wire is now wound the inside of the loop. You will have to drill one more hole on the bottom arm about 1 inch above the first hole. Attach one end of the wire to the wire connector and then string the wire through the holes around the loop until you reach bottom again. Keep the wire fairly tight so there is little or no slack on the winding. Wind the end of the wire through the second hole on the bottom arm and attach this end to a separate section of your wire connector. The two ends must remain separate and not attached.

#### ATTACHING THE COAX FEED LINE

To attach the coax feed line to your loop strip off some of the covering to expose some of the center conductor and some of the braid. Attach the center of the coax to one side of the connector and the braid to the other side of the connector which the pick up loop is attached to.

Check these connections to insure that they are tight and that they are isolated from each other.

If you want you can try placing a capacitor in line with the center feed of the coax. I used a 680 pf capacitor to help match the loop and the coax . Do not attach this to the braid of the coax.

#### WINDING THE MAIN COIL

To wind the main coil of the loop Solder the end of you wire to the solder lug on the variable capacitor . Then proceed to wind the wire around the loop pushing the wire into the groves on the end pieces of the arms. After you have completed winding the wire around the loop attach the end of the wire to the from of the capacitor with some solder. The winding such be kept a tight as possible as you did on the pick up loop. You are now ready to tune the loop.

#### TUNING THE LOOP

The first step is to attach the coax feed line to your receiver. Tune the radio to around 1000 kHz.

Tune the capacitor to peak the signal even if it is just static. Now go up and down the band

peaking the capacitor to see what the loop's true range is. You will have to re-tune the capacitor

about every 50 to 100 kHz. You will probably find that you can not tune the top of the band

(1710 kHz). If this is the case then take one winding off of the loop by unsoldering the wire

attached to the frame of the capacitor and unwinding once around the loop. Cut the wire and

reattach the new end to the frame. Re-tune the loop and see what its new range is.

With the plates meshed in you should be able to tune to about 525 kHz and with them fully out to

about 1710 kHz. You may have to take off 1 or 2 or even 3 windings to tune the loop to insure it covers all the frequencies. If you take off more than one winding make sure that you end up with a balanced number of open grooves on each end of the end pieces.

#### COMPLETED

Once you have this all set up the loop is ready to use and the DX will flow in. You will have to experiment with tilting and rotating the loop to get the best nulls possible. The main things to remember are:

- Tune the capacitor to the frequency you are listening to for the best signal.
- Rotate the loop to get a null as deep as possible.
- Tilt the loop to increase the null.
- Experiment with tilting and rotating slowly to peak the nulls as best you can. You may find that the nulls are very narrow and you have to be careful.
- The best nulls are a combination of tilt and rotation.
- Using a vernier tuning knob will allow you to fine tune for the best signal peaks.

Please remember this is a guide and NOT written in stone. Feel free to experiment with the plans to suit your needs and situation.

If you have any questions please write me care of saxelrod@mb.sympatico.ca

## Link to further loop information.

- [bulletAntennas for MW](#) by Don Moman
- [bulletLoop Antennas](#) On the HCDX site
- [bulletDXers Tool Box](#) Has a construction article.
- [bulletMinnesota DX Club](#) Loop Information
- [bullet1 Meter Loop](#) From Radio Australia.
- [bulletA Remotely Tuned MW Loop](#) Construction Article.
- [bulletJoe Carr's Tech Notes](#) Has articles on antennas.
- [bulletVans Think Tank](#) Contains a good list of antenna links.
- [bulletThe Electronics Hobby Page](#) Another site with a excellent listing of antenna and DXing links.

[bulletThe Electronic Hobby Page](#) Has an extensive list of loop and radio information.

[bulletLoop Discussion](#) Has postings from various USNET groups.

[bulletSmall Transmitting Loop](#) for the HF band also has links to other loop sites.

[bulletBelar](#) LP-1 and LP-1A AM shielded loop antenna

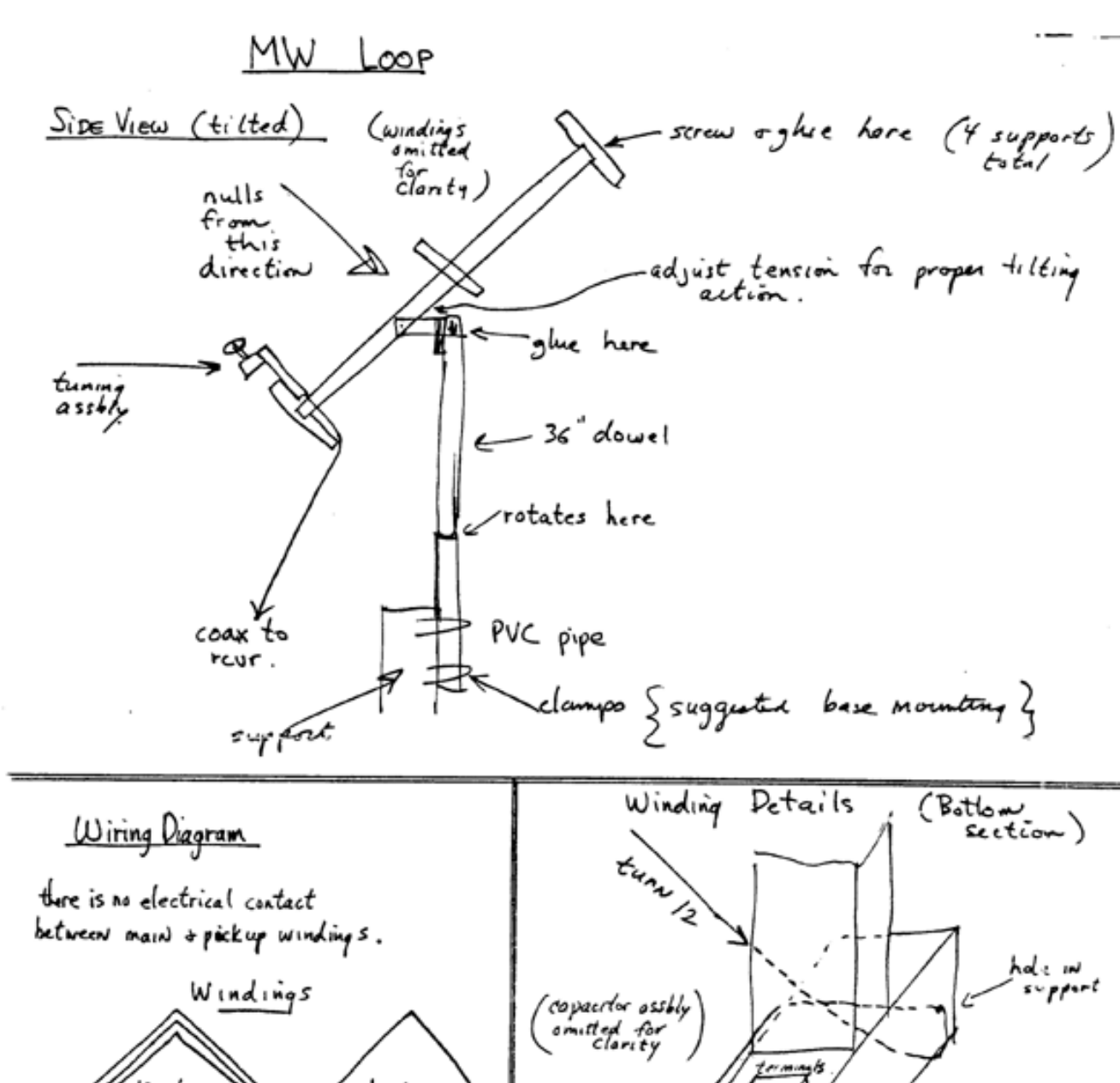

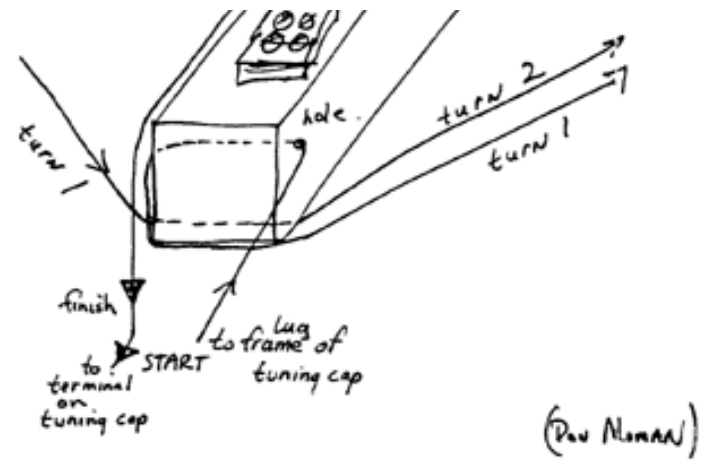
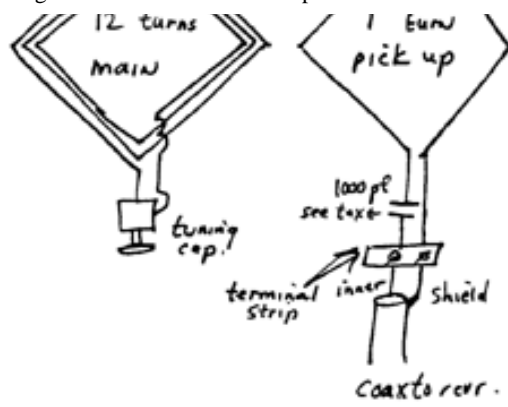

(Don Norman)

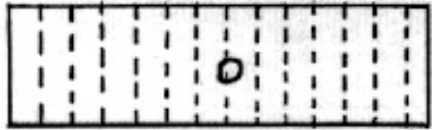

FIGURE A  
End Piece Top View

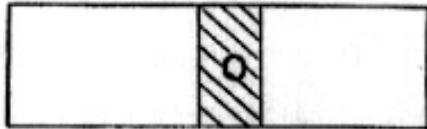

FIGURE B  
End Piece Bottom View

Cross Arm Bottom View

FIGURE C

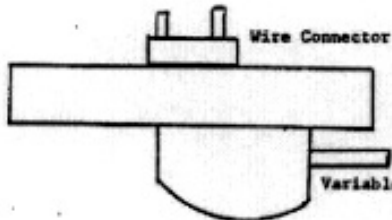
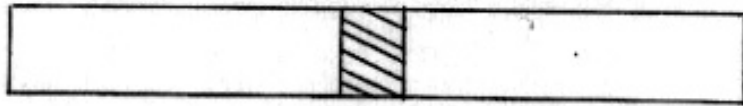

FIGURE D  
Tuning Section Side View

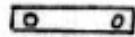

FIGURE E  
Brace Side View

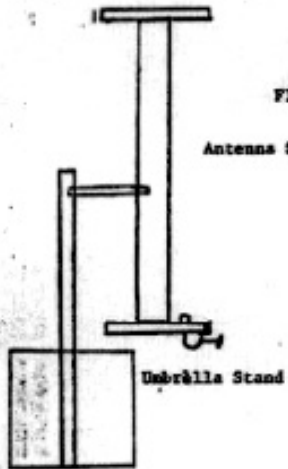

FIGURE G  
Antenna Side View

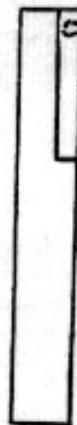

FIGURE F  
Dowel Side View

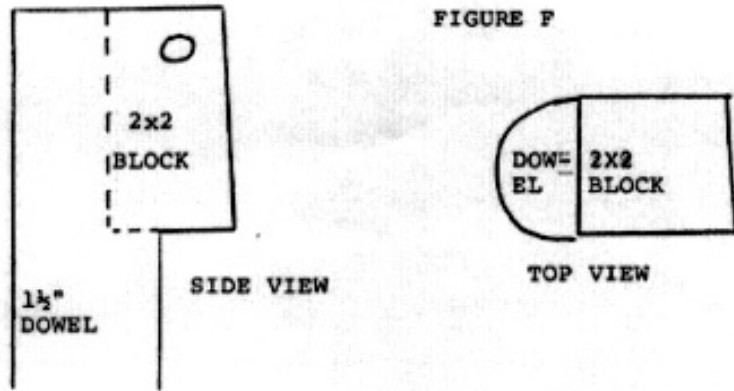
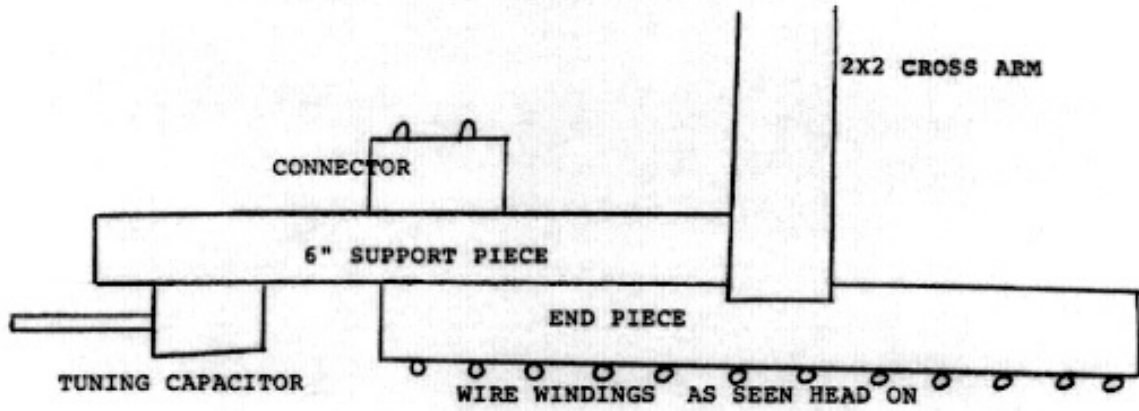
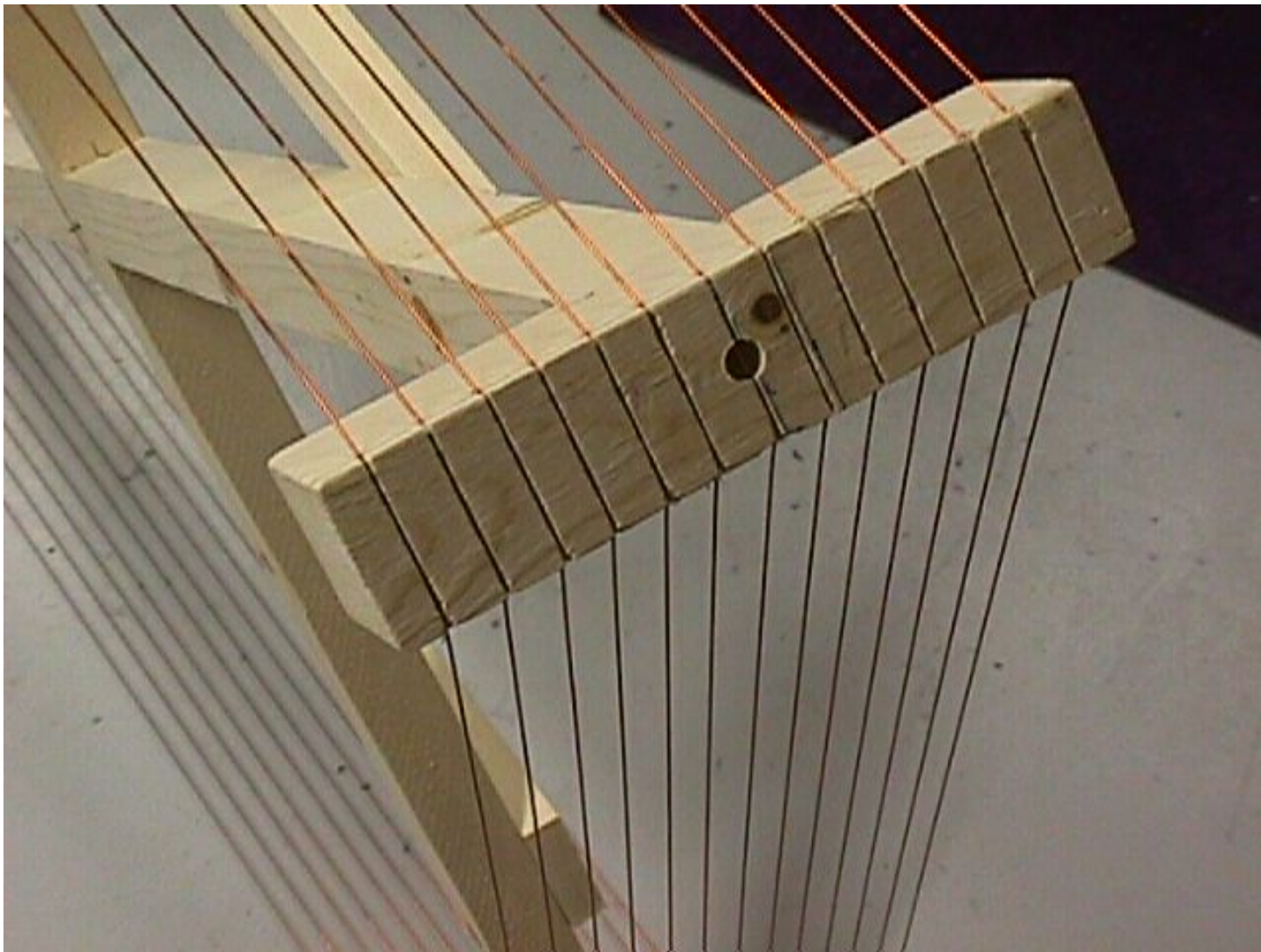

FIGURE D TUNING BOARD











Here is a pic of the loop Tom Doty built with some mods to the plans above. He used a microphone stand.



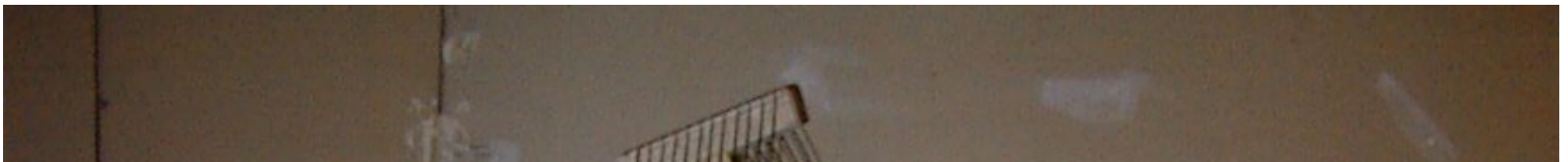
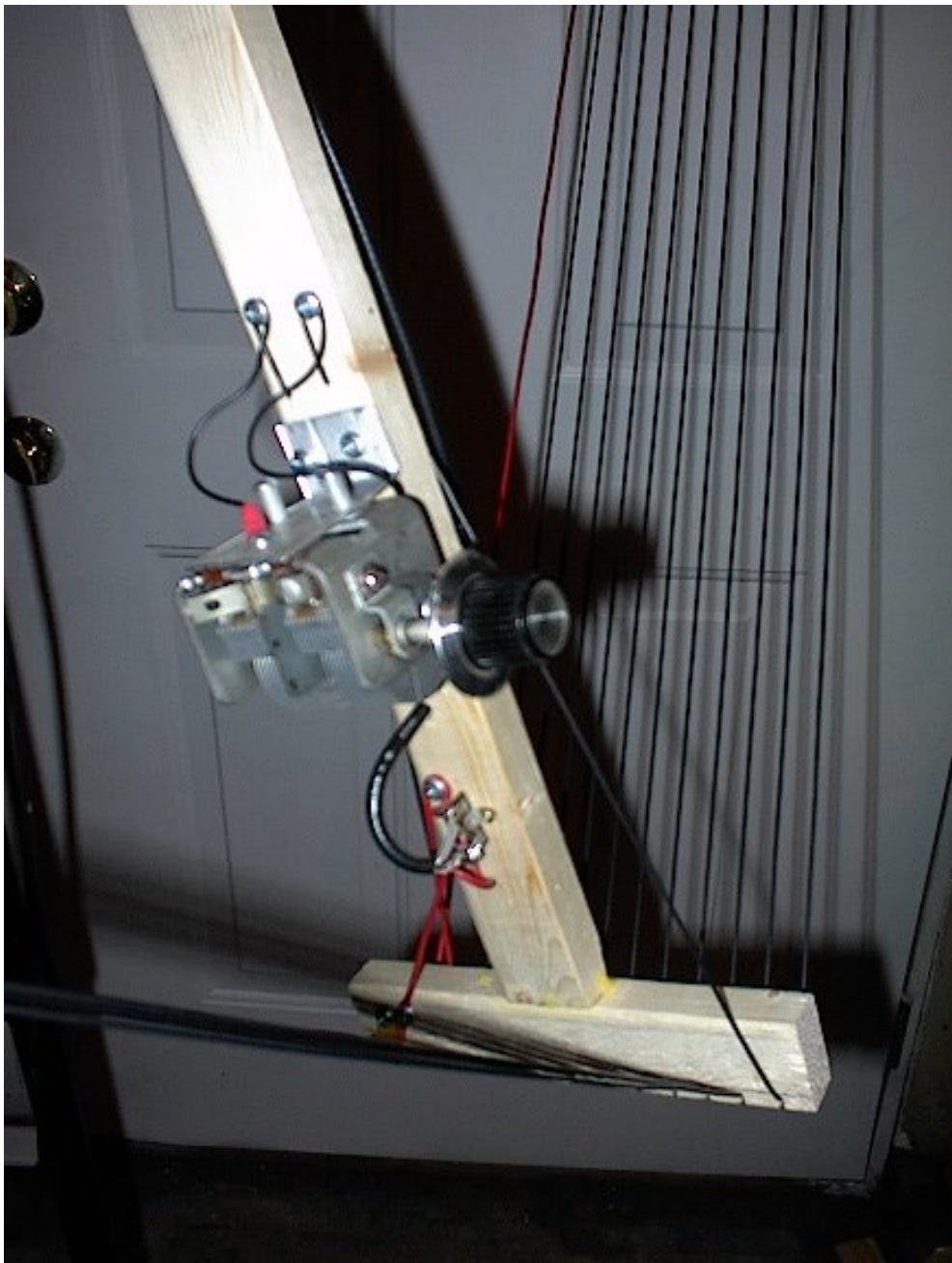





[RETURN TO MAIN PAGE](#)

Remember On A Clear Day You Can Hear Forever

## AM/FM Reception Tips

Jump to:

- [AM Reception](#)
- [FM Reception](#)
- [Sources for AM and FM Antennas](#)

Also view our:

- [CPR Network Map](#)
- [Statewide 2-Channel Details](#)
- [Program Descriptions and Schedule](#)
- [Listen online!](#)

Colorado Public Radio transmits signals from AM and FM station and translator antennas across the state. All radio reception is affected by distance, physical obstacles and other broadcast signals. But often the handicaps imposed on radio signals can be lessened with relatively simple enhancements. Below are some general tips and a few examples of the kinds of antennas that may improve your reception. At the end we suggest some places to find a wide array of antennas to help you enjoy your radio more.

---

### What Affects AM Reception

AM reception, which travels both on the ground and through the air, is prone to interference by a variety of sources: other radio stations, lightning storms, and nightfall, when an outlying AM station's signal can reflect off the ionosphere and skip over areas that receive the signal during the day.

### How To Improve AM Reception

With their external antennas, **car radios** tend to receive AM radio best, but sound and signal quality varies from car to car. Cars that employ their rear window defrosters as antennas may receive AM signals better than those with traditional external antennas; some people can find improvement by replacing their factory-installed antenna with an aftermarket antenna of higher quality. Reception may be disturbed as a car moves from one location to another, passing in and out of areas where the signal is obstructed by power lines or tall buildings.

**Portable and desktop radios** also often work well with AM broadcasts. Many contain internal, ferrite loop antennas; sometimes the power cord is also the antenna. These antennas are relatively directional, meaning that the quality of the received signal

changes depending on where you put the radio. You may improve reception simply by moving your radio around until you are able to catch more of the signal. In some cases an external AM antenna may improve reception with a portable radio as it does with a component receiver.

When it comes to AM reception, not all **component AM/FM receivers** are created equal. Some have built-in antennas; some do not. Many high-end receivers, however, do have an external connection for an **AM loop antenna**, which might have come with the receiver when you purchased it. If your stereo receives AM poorly or not at all, you will need to install this loop antenna-usually a rectangular piece of plastic with two wires that connect to two screws on your receiver-and orient it appropriately for the best reception.



Better external loop antennas are also available. These are usually 8 to 12 inches in diameter and can be oriented and tuned just like you tune your radio to help eliminate nighttime interference and noise. Some must be hooked up directly to the external connections on your receiver; others need only be placed in close proximity to your receiver's existing AM antenna.



---

## What Affects FM Reception

FM broadcasts deliver greater audio fidelity and are less susceptible to static, but they do have their own reception-related challenges. All radio waves travel in straight lines, and an unobstructed, line-of-sight path to a transmitting antenna makes for the best FM reception. Naturally, the farther the signal reaches, the weaker it gets, especially when out of line-of-sight. And when there are reflecting surfaces-tall buildings or mountains, for instance-near your receiving antenna, FM radio waves are also prone to a disturbance known as "multi-path." Like ripples in a small pool, these multiplied waves can cancel out the original broadcast signal at select points.

## How To Improve FM reception

Because of multi-path reception, **car radios** are usually the worst receivers for FM. As your car moves, your antenna gathers signal reflections from multiple directions, wiping out the stereo portion of the signal and adding noise. One solution is to shorten the height of your antenna, reducing the sensitivity of your tuner so that it locks in on only the main broadcast signal.

**Portable and desktop radios** often have telescoping antennas or use the power cord or headphone cord as the antenna. When using one of these receivers, the position of the unit and the orientation of the antenna can be critical. If your receiver uses its power cord as an antenna, stretching out or moving the cord can improve reception. The same is true for units using the headphone cord as the radio antenna.



Most high-end **component AM/FM stereo receivers** require an external antenna, and many manufacturers supply the simplest kind: a T-shaped, flexible wire antenna called a **dipole antenna**. Attach this to the receiver's antenna terminals and orient the dipole as needed for best reception. If the dipole offers no appreciable improvement, you may need an external antenna. Designed specifically for FM reception, these look like TV antennas and are usually installed on a roof, on the sides of buildings or in an attic. Again, after connecting the antenna to your receiver, orient it until you get the best reception.

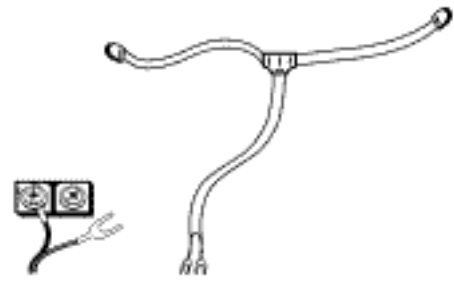

---

## Sources for AM and FM Antennas

First, a word of caution: Make sure that any antenna you purchase is returnable if it does not give you the result you desire. That said, there are many sites both locally and on the Internet that offer antennas or the instructions necessary for building your own.

Radio Shack and similar electronics and hardware stores often stock antennas for both AM and FM reception. A good **AM loop antenna** sells for \$10 to \$50 depending on features and looks. FM antennas and combined AM/FM antennas are often available as well, for prices that can range from \$20 to \$200 depending on the features you want. Often it is best to call around first to find someone knowledgeable about radio antennas. And there are also many online resources, including:

<b>Radio Shack:</b>	<a href="http://www.radioshack.com">www.radioshack.com</a>
<b>Terk Technologies:</b>	<a href="http://www.terk.com">www.terk.com</a>
<b>C. Crane Company:</b>	<a href="http://www.ccrane.com">www.ccrane.com</a>
<b>OneCall:</b>	<a href="http://www.onecall.com">www.onecall.com</a>

If you find a good source for information and products for improving reception, please let us know, either by calling 1-800-722-4449 or by [contacting us online](#).

---

[ [Home](#) ] [ [Listen](#) ] [ [Support](#) ] [ [Schedules and Links](#) ] [ [Classical Music Playlist](#) ] [ [Colorado Matters](#) ] [ [Colorado Spotlight](#) ] [ [Events](#) ] [ [People/Info](#) ] [ [Contact](#) ]

*Site Designed and Developed by Colorado Public Radio.*  
[Privacy Statement](#)



[|Antennas|](#)[|AmDx|](#)[|Clubs|](#)[|Ham|](#)[|Pirate|](#)[|Rcvrs|](#)[|UTE|](#)[|Bookmarks|](#)[|QSO|](#)[|LogBook|](#)

# DX News, Tips, and Info

## Recent DX News and Tips



- [Special Shortwave Broadcasts during SWL Winterfest from Radio Europe and WBCQ.](#) - via Cumbre DX
- [Changes at BBC Ws North American Service](#)
- [BBC Ws Frequencies no longer used by the BBC to America](#)
- [BBC Ws Frequencies still being used to South America](#)
- [Vacation BCL Contest 2002](#)
- [OH8TA's DxPedition to Hailuto Island](#)
- [Standoff between US government and Kentucky State Militia Radio](#) - from Cumbre DX Special
- ["Media Network" Radio Netherlands' DX Radio Show Ended!!!](#)
- [Listen to NPR over AFRTS shortwave relays](#) - in Upper Sideband!
- [BUG in PGP](#) - PGP Security - PGP ADK Security Advisory
- [JITC Tadi/Link-11 ran Test Schedules.](#)
- [Enigma Machine Stolen from Bletchley Park](#)
- [The latest Cumbre DX Special Edition](#) - from Cumbre DX
- [Cumbre DX sends spare parts to Radio Gaalcaya!](#) - You too can help!
- [Glenn Hauser's World of Radio Page](#)
- [Glenn Hauser's DX Listening Digest](#)
- [Radio H.F. Internet Newsletter](#) - By Sheldon Harvey

- [When it's Hurricane Season!](#) - - various links
- [Check Out my friend DJ Stevie's RADIO 510 Webpage](#)
- [Listen in Real Audio to Radio 510's Special SWL Winter Fest Program.](#) - from KIDD
- [Information about the 14th Annual Winter SWL Festival - March 9 and 10, 2001](#)
- [Sights and Sounds from The 1998 12th Annual SWL WinterFest](#)

## *Recent Information Posted on Various Listservers:*

### *2m list*

- [Re: \[2M\] Greenville SC repeaters](#)  
Sat, 2001 Nov 17 05:26:26 *Walt R Mitty* <rgdong@juno.com>

### *50Mhz list*

- [\[50MHz\] VHF: 6m 8877 Amplifier Efficiency](#)  
Sat, 2001 Dec 1 15:56:32 *Lance Collister* <w7gj@bigskyspaces.com>

### *amfmtvdx list*

- [\[AmFmTvDx\] Saturday HCI 40 Meter Net](#)  
Fri, 2001 Nov 30 22:10:04 "*Duane Fischer, W8DBF*" <dfischer@usol.com>
- [\[AmFmTvDx\] HCI Global Glow Tonight](#)  
Wed, 2001 Nov 28 10:14:29 "*Duane Fischer, W8DBF*" <dfischer@usol.com>

### *HardCoreDx Listserver*

- [\[HCDX\] test tranmisson to North America 23-25 December](#)
  - *From: "Konstantin Gusev"* <gusev@itep.ru>

### *hsms list*

- [\[HSMS\] Leonids pictures](#)  
Sun, 2001 Nov 25 18:00:47 "*Shelby Ennis, W8WN*" <w8wn@arrl.net>

### *milcom list*

- [Re: \[MilCom\] Altitudes Question](#)  
Wed, 2001 Nov 14 09:26:49 *Ken Litton* <klitton@highpoint.net>

### *rec.radio.shortwave*

- [What radio should I buy?](#) - various, rec.radio.shortwave news group

### *spooks list*

- [\[Spooks\] N&O #43](#)

Sat, 2001 Dec 1 11:39:25 [ary@luna.nl](mailto:ary@luna.nl)

- [\[Spooks\] Telephone History](#)

Tue, 2001 Nov 27 17:06:20 "Schlake ( William Colburn )" <[schlake@nmt.edu](mailto:schlake@nmt.edu)>

*swl list*

- [\[SWL\] Radio Bangladesh](#)

Sat, 2001 Dec 1 02:29:33 [Thomas Roth](mailto:th.roth@knuut.de) <[th.roth@knuut.de](mailto:th.roth@knuut.de)>

- [\[SWL\] ALL INDIA RADIO : B-2001 COMPLETE SW SCHEDULE](#)

Fri, 2001 Nov 16 13:07:42 [Thomas Roth](mailto:th.roth@knuut.de) <[th.roth@knuut.de](mailto:th.roth@knuut.de)>

- [Yacht Boy 400 Problem](#) - Joseph Lee, SWL list  
[re: Yacht Boy 400 Problem](#) - Duane Fischer, SWL list

*wun list*

- [\[WUN\] Artic Radio](#)

Sat, 2001 Dec 1 21:27:18 [Jack NeSmith](mailto:nesmith@bitstorm.net) <[nesmith@bitstorm.net](mailto:nesmith@bitstorm.net)>

- [\[WUN\] AERO: Arctic Radio ARINC on 8891](#)

Sat, 2001 Dec 1 18:08:23 "Mike Leary" <[mleary2001@montana.com](mailto:mleary2001@montana.com)>

- [Info on Monitoring Shuttle Launch!](#) - R.Baker & A.Stern via WUN Listserver
- [Slow Scan TV Project on MIR!](#) - from AE4RO & WUN Listserver



## ***Selected Radio Monitoring Listservers with News & Tips***

- Recent postings on [HARD-CORE-DX listserv](#) - archive for 2000
- Recent postings on [Rec.Radio.Shortwave](#) - on Deja.com
- Recent postings on [Rec.Radio.Shortwave](#) - on InfoCop.Com

Check out these listservers from [QTH.net](http://QTH.net):

- Archive of [Recent postings on the AMFMTV DX](#) listserv
- Archive of [Recent postings on the ANTENNAS](#) Listserv
- Archive of [Recent postings on the ACARS](#) Listserv
- Archive of [Recent postings on the ACARSLOGS](#) Listserv
- Archive of [Recent postings on the ATLANTIC](#) Listserv

- Archive of [Recent postings on the BOATANCHORS Listserver](#)
- Archive of [Recent postings on the MILSURPLUS Listserver](#)
- Archive of [Recent postings on the FEDCOM Listserver](#)
- Archive of [Recent postings on the HEARSAT-L Listserver](#)
- Archive of [Recent postings on the LOWFER Listserver](#)
- Archive of [Recent postings on the MILCOM Listserver](#)
- Archive of [Recent postings on the SCANNER Listserver](#)
- Archive of [Recent postings on the SPOOKS Listserver](#)
- Archive of [Recent postings on the SWL Mailing List](#)
- Archive of [Recent postings on the WUN listserver](#)

## **Selected Radio Monitoring email lists on [the Yahoo eGroups Listserver](#)**

- |  |                                  |                                   |                                    |
|--|----------------------------------|-----------------------------------|------------------------------------|
| ● <a href="#">Amateur-repairs</a>      | ● <a href="#">If-vlf-elf</a>     | ● <a href="#">RailScan</a>        | ● <a href="#">scantech</a>         |
| ● <a href="#">amfmtv</a>               | ● <a href="#">MidlandPirates</a> | ● <a href="#">RealDX (audio)</a>  | ● <a href="#">scan_ky_wv</a>       |
| ● <a href="#">antenna</a>              | ● <a href="#">Milcom2</a>        | ● <a href="#">Real-Scan-Audio</a> | ● <a href="#">scan_michigan</a>    |
| ● <a href="#">antique-radio</a>        | ● <a href="#">MML</a>            | ● <a href="#">safs</a>            | ● <a href="#">SoCalTalkRadio</a>   |
| ● <a href="#">armyradios</a>           | ● <a href="#">MNscan</a>         | ● <a href="#">scan-l</a>          | ● <a href="#">SWpirates</a>        |
| ● <a href="#">Broadcast-Band-DXing</a> | ● <a href="#">MONIX</a>          | ● <a href="#">scan-nyc</a>        | ● <a href="#">swrs</a>             |
| ● <a href="#">cnjscanner</a>           | ● <a href="#">monmouth-races</a> | ● <a href="#">SCAN-PA</a>         | ● <a href="#">TampaScan</a>        |
| ● <a href="#">connscan</a>             | ● <a href="#">mtl-scan</a>       | ● <a href="#">ScanAtlanta</a>     | ● <a href="#">TexasScan</a>        |
| ● <a href="#">cothen</a>               | ● <a href="#">MWDX-Midwest</a>   | ● <a href="#">scanbucks</a>       | ● <a href="#">TpaBayscanner</a>    |
| ● <a href="#">dxbands</a>              | ● <a href="#">ni_scanner</a>     | ● <a href="#">ScanColo</a>        | ● <a href="#">TubeSWL</a>          |
| ● <a href="#">FloridaScan</a>          | ● <a href="#">nnj-scan</a>       | ● <a href="#">scancolumbus</a>    | ● <a href="#">UKMidlandscanner</a> |
| ● <a href="#">frequencies</a>          | ● <a href="#">nordic-vhf</a>     | ● <a href="#">ScanCom</a>         | ● <a href="#">usedhamgear</a>      |
| ● <a href="#">ham4sale</a>             | ● <a href="#">NZSCANNERS</a>     | ● <a href="#">ScanIndiana</a>     | ● <a href="#">UtahScanner</a>      |
| ● <a href="#">Hamfest</a>              | ● <a href="#">OHfreqex</a>       | ● <a href="#">scaniowa</a>        | ● <a href="#">VermontScanner</a>   |
| ● <a href="#">HobbyScanning</a>        | ● <a href="#">OTTAWASCAN</a>     | ● <a href="#">scanner</a>         | ● <a href="#">vhfskip</a>          |
| ● <a href="#">i95-scanning</a>         | ● <a href="#">PacificRimDx</a>   | ● <a href="#">SCANnorCAL</a>      | ● <a href="#">VirginiaScanner</a>  |
| ● <a href="#">icdx</a>                 | ● <a href="#">PacNWMilCom</a>    | ● <a href="#">SCANSNE</a>         | ● <a href="#">waveguide</a>        |
| ● <a href="#">ISSmonitors</a>          | ● <a href="#">phlscanner</a>     | ● <a href="#">scansweden</a>      | ● <a href="#">wpascanner</a>       |
| ● <a href="#">kc-scanning</a>          |                                  |                                   |                                    |

[TOP](#) | [Antennas](#) | [AmDx](#) | [Clubs](#) | [Ham](#) | [Pirate](#) | [Rcvrs](#) | [UTE](#) | [Bookmarks](#) | [QSO](#) | [LogBook](#) |

# AM BroadCast Band DX News

## AM-DX News Flash

- [AM-DX NEWS FLASH - June 07 2001](#) (62k)
- [AM-DX NEWS FLASH - June 14 2001](#) (31k)
- [AM-DX NEWS FLASH - June 28 2001](#) (100k)
- [AM-DX NEWS FLASH - June 14 2001](#) (73k)
- [AM-DX NEWS FLASH - June 28 2001](#) (57k) 

## BCB Reports and DX peditions

- Archive of [Recent postings on the AMFMTVDX](#) listserver
- Directory list of [AMFMTVDX listserver archives](#) in Digest format.
- [Subscribe to the AMFMTVDX Listserver](#) - type **subscribe amfmtvdx** in the message Body  
*Post a logging to the AMFMTVDX Listserver at: [amfmtvdx@qth.net](mailto:amfmtvdx@qth.net).*
- [Canadian DX Message Board with BCB DX](#)
- [FM & TV DX skip announcements](#) From Finland.
- [Broadcast Band DX Propagation Log](#)  
An interactive log book for reporting BCB DX Openings!
- [Report from Newfoundland 97 DXpedition](#) - on Werner Funkenhouser's site
- [Mika Makelainen's DXpedition to Lemmenjoki, Finland](#)

## BCB DXing Clubs & Organizations

- [AMANDX Canadian DX Website](#)
- [IRCA, International Radio Club of America Homepage](#) -- [IRCA Text Homepage](#)

- [CPC DX Tests from the IRCA and NRC](#)
- [LWCA, LongWave Club of America Homepage](#)
- [MWC, Medium Wave Circle home page](#)
- [NRC, National Radio Club Homepage](#)
- [DXLC, DX Listener's Club LW to SW Beacon List](#)
- [WTFDA, World TV/FM DX Assciation.](#)

## **BCB DXing Lists and Loggings sites**

- [Werner Funkenhauser's WHAMLOG and Mediumwave DX Links.](#) - Terrific website!
- [William Demmery's Canadian AM Radio Directory](#) - find those Canadian Unids here!
- [David Onley's Mediumwave DX Page](#) - in Australia
- [Lee Freshwater's BCB DX Logbook](#)
- [Peer Axel's European MW page](#)
- [Peer Axel's Medium Wave Frequency Survey for Central Europe](#)
- [David Sharp's Most Excellent Homepage](#) - Moderator AMFMTV DX Listserve
- [Robert Kramer's Medium Wave Homepage](#)
- [Paul Ormandy's South Pacific DX Resource Page](#) - good BCB DX resource
- [Medium Wave Alliance home page](#)
- [DX midAMerica Web page](#)
- [Medium Wave DXing in Northeast USA](#)
- [Mizar's AM Radio page](#) - w/loggings
- [Joseph Cooper's Tuning Up Your BCB Monitoring Station](#)
  
- [FTP site with list of North American BCB stations \(whamlog.zip\)](#)
- [Search FCC Datadase for AM Radio Stations](#)
- [Airwaves' FCC Broadcast Station Database Search](#)
  
- [Bob's list of Long Wave DXing Links](#)
- [Industry Canada Frequencies Lists](#)
- [AMANDX AM/FM/TV UNIDs Message Board](#)
- [AE4RO, Tom's AM BCB QSLs](#)
- [AM BCB DX Audio Files](#) - in RealAudio
  
- [AM Broadcast Band DX List](#) - from various sources (searchable)
  
- [Industry Canada's North America AM List](#) - from Werner Funkenhauser's Archives
  
- [Broadcast Station Location Page by John Kodis](#) - may be down..
- [Chris Ridley's European And UK Frequency Lists](#) - AM,FM
- [Search Ultimate's US TV Station Lists](#)

- [AM Broadcast Station Search](#) - from ASD at fcc.gov
  - [FM Broadcast Station Search](#) - from ASD at fcc.gov
  - [TV Broadcast Station Search](#) - from ASD at fcc.gov
  - [Other goodies on the FCC Audio Services Division site](#)
- 
- Archive of [Recent posting on the LOWFER](#) - Listserver

## ***TIS and Extended Band info***

- [Bill Harms' TIS and HAR Frequency List web page](#)
- [Harry Helms' Extended AM Band Logging page](#)
- [Shawn Axelrod's North American XBAND List](#) - AMANDX website
- [FCC Authorized Expanded Band Allotment plan](#) - on USNET by Mark Roberts
- [Dale Bickel's TIS Frequency Search](#) - from ASD at fcc.gov

## ***TV and FM Monitoring Info***

- [Jeff Kadet's TV DX Photos](#) - Great TV DX Site
  - [Buttle's TV Schedules of the World](#)
  - [G4FBZ's DXTV at the height of Cycle 22](#) - [DXTV Photos](#)
  - [Fernando Garcia's TV DX via tropo](#) - from Mexico
  - [Identifying TV DX from Mexico](#) - from NLADxer
  - [NLADxer's TV DX EXHIBITION](#)
  - [Ecola Newstand TV Station list](#)
  - [TV Broadcast station search](#) - from ASD at fcc.gov
  - [TV Guide Eastern Zone edition](#)
- 
- [US TV Station lists.](#)
  - [USA TV Online](#) - Good TV/FM station Search
  - [Broadcast Station Location Page by John Kodis](#) - search for TV stations
  - [Search Ultimate's US TV Station Lists](#)
  - [Ultimate TV Homepage](#)
  - [TV Carrier Frequencies in the US](#)
  - [Pacific area TV video carriers](#)
  - [US TV Carrier Frequencies](#)
  - [TV Transmitters in Africa and Middle East](#) - From Equinox
  - [TV Transmitters in Far East and Pacific](#) - From Equinox



- [TV Transmitters in Europe](#) - From Equinox
- [The Radio and Television Transmitters list](#)
- [The Radio and Television Transmitters Site](#)
  
- [British TV & FM Circle Homepage](#)
- [DDXLK, Dansk DX Lytter klub](#) - with TV/FM
- [WTFDA, World TV/FM DX Assciation.](#)
- [The FM & TV DX Plaza](#) - From Finland.
- [FM & TV DX Plaza skip announcements](#) - From Finland.
- [Fred Cantu's Mexico Radio & TV Lists](#)
- [WB2VVV's Radio Page with FM Dxing info](#)
  
- [The FM DX Web](#) - w/syndicated lists
- [Elliott Broadcast Services FM Database](#)
- [Radio TV Dial Pages](#)
- [Matt's Tallahassee TV DX Page](#)
- [Mikes's FM DX Page](#)
- [FM Broadcast station search](#) - from ASD at fcc.gov
- [Search the FCC's AM/FM database](#)
- [Industry Canada Frequencies Lists](#)
  
- [TV/FM Skip Log](#)
- [26 mHz FM Relay Stations](#) - posted on WUN

[TOP](#)|[Antennas](#)|[AmDx](#)|[Clubs](#)|[Ham](#)|[Pirate](#)|[Rcvrs](#)|[UTE](#)|[Bookmarks](#)|[QSO](#)|[LogBook](#)|

## Selected UTE Sites with News & Tips

- [Bob's UTE News Web Page](#) - on this site!
- [Mike's OhioScan & DXing Page](#)
- [Spy Centre: Spy Numbers Stations](#)
- [Hugh Stegman's Utility World](#)
- [The Spooks Newsletter, Numbers and other oddities](#) - Good numbers Info
- [Ian Julian's Pacific-Rim Monitor page](#)

- [Marius Rensen's HF-FAX Web Page](#)
- [PY2VHF's UTE Webpage](#)
- [Rick "RD" Baker's UTE page](#)
- [World Wide Utility News, WUN Homepage](#)
- [The European Utility Newsletter](#)
- [Scramble Intelligence Service Bulletin](#)
- [Monitoring Times](#)
- [BDXC's WEFAX Information and Frequencies](#)
- [WUN Military Channel Designator's List](#)
- [Tigger's Military Callsigns list Page](#)
- [Richard Lacroix's Military Communications Home Page](#)
- [ITU Ship's database. Interogate for callsign, name or selcal.](#)
- [Aerobeacons web site](#)
- [Klingenfuss's Hot Frequency List](#)
- [DIGI and RTTY Decoder Information](#)
- [Plan of the Day Report](#) for the Hurricane Hunters
  
- [The Community Air and Space Report.](#) - (satellite and shuttle info)
- [TODAY at NASA, daily space news updates](#)
- [Receiving Space Shuttle Voice Communications](#) - on USENET by H.Flashman
- [IRC #monitor Information](#) - on A Pile's Site
- [Subscribe to VHFSKIP Listserver](#)
  
- Archive of [Recent postings on the WUN](#) listserver
- Archive of [Recent postings on the MILCOM](#) listserver
  
- [Al Waller's QTH.NET Mailing Lists](#) - all the lists you could ever want!



## *UTE News and Information Page*

---

# Selected HAM Radio Sites with News & Tips

- [Amateur Radio Links and Info page](#)

- [AC6V's DX News page](#)
- [AE4RO, Brother Tom's Homepage](#)
- [AMSAT News Service](#)
- [Al Waller's QTH.NET Mailing Lists](#) - all the lists you could ever want!
- [Bry's Ham Radio Files page](#)
- [Buckmaster World Wide Ham Call Search](#)
- [DARC - Deutscher Amateur Radio Club](#)
- [DK3XT's Make More Miles on VHF](#)
- [DXER.ORG, "DX NEWS"](#) - Various Ham Info, News & Links
- [Equinox HF News page](#)
- [Equinox HAM Radio Web site](#) - Specializing in VHF/UHF
- [kg7fu's Linux Ham Pages](#)
- [NCDXF/IARU International Beacon Network](#) - 20 to 10 meter beacon info
- [QSL.NET](#) - Various Ham sites provided by Al Waller
- [Tony Lacy's NuMorse / NuTest HAM Page](#) - (Starting out Ham Info)
  
- [Ham Radio FAQ #1 on Oakland.edu](#)
- [Ham Radio FAQ #2 on Oakland.edu](#)
- [Ham Radio FAQ #3 on Oakland.edu](#)
  
- [List of DX Packet Clusters](#)
- [OH2BUA DX Web Cluster World Desk](#)
- [The JA Web Cluster in Japan](#)
- [the DX Web Cluster in Japan](#)
- [the DX Propagation Logger](#) - for posting Propagation Alerts.
- [real-time Greyline Map](#) - in black & white
- [Near-Real-Time MUF Map](#) - shows Greyline
- [Last 25 WWV reports](#)

## ***Amateur Radio Listservers***

- Archive of [Recent postings on the \*\*2M\*\* Mailing List](#)
- Archive of [Recent postings on the \*\*50MHZ\*\* Mailing List](#)
- Archive of [Recent postings on the \*\*NEWSVHF\*\* Mailing List](#)
- Archive of [Recent postings on the \*\*BUTLER VHF\*\* Mailing List](#)
- Archive of [Recent postings on the \*\*ELECTCHESTER VHF\*\* Mailing List](#)
- Archive of [Recent postings on the \*\*ROCKY MOUNTAIN VHF\*\* Mailing List](#)
- Archive of [Recent postings on the \*\*VHF-EA-CT\*\* Spanish Mailing List](#)

- Archive of [Recent postings on the HSMS Mailing List](#)
- Archive of [Recent postings on the METEOR-SCATTER Mailing List](#)
- Archive of [Recent postings on the 222EME Mailing List](#)
  
- Subscribe to the [UK VHF-CONTESTS Reflector](#)
- Subscribe to the [UK VHF-DX-DISCUSS Reflector](#)
- Subscribe to the [UK VHF-DX-WARNINGS Reflector](#)
- Subscribe to the [USA 6 Meter Reflector](#) - Type **subscribe six-list** in the message body.
- Subscribe to the [Japanese VHF Reflector](#) - Type **subscribe 6m-dx** in the message body.
- Subscribe to the [Swedish VHF Reflector](#) - Type **subscribe vhf** in the message body.
- Subscribe to the [Swedish EME Reflector](#) - Type **subscribe eme** in the message body. - [Info here!](#)
- Send message to [Moon-Net EME Listserver](#) - or [Get Mailinglist Commands](#)
  
- Ham DX Info [rec.radio.amateur.dx](#)
- Ham Misc Info [rec.radio.amateur.misc](#)
- Ham Antenna Info [rec.radio.amateur.antenna](#)
- Ham Equipment [rec.radio.amateur.equipment](#)
- Ham HomeBrew [rec.radio.amateur.homebrew](#)



## *Amateur Radio Links and Information Page*



## Free & Pirate Radio Sites with News & Tips

- [Alfa Lima International](#)
- [Andrew Yoder's HobbyBroadCasting.Com](#)

- [Clandestine Radio Broadcasting Web Page](#) - List of Clandestines around the world
- [Hermon Boel's, "Free Radio Stations" list](#)
- [the Free Radio WebRing](#) - maintained by WKJCE
- [Mining Company's Pirate/Free Radio Page](#)
- [Nick Grace's Clandestine Radio Intelligence Web](#)
- [Nick Grace's page on ClandestineRadio.com](#)
- [Radio Waves International Free Radio Web Page](#)
- [Chris Smolinski's PIRATE Page](#)
- [Peer Axel's Alternative Radio for Europe](#)

### **Clandestine Radio Watch, CRW**

- [Clandestine Radio Watch Newsletter](#)
- [Pirate Radio Pages](#)
- [QSL Information Pages](#)
- [Martin Schoech's SRS Deutschland Radio Home page](#)

### **Free Radio Network, FRN**

- [FRN Top Home page](#)
- [ACE Home page](#)
- [ACE Articles & News](#)
- [ACE Past Loggings page](#)
- [FRN Chat](#)
- [FRN's "Grapevine"](#)
- [Radio Free Internet](#) - by Andrew Yoder
- [RFI's Pirate News](#)
- [RFI's Pirate Station list](#)
- [Kirk Trummel's Workshop](#)

### **Free Waves**

- [Free Waves Web site](#) - in Italy
- [Free Waves' "Hot News"](#)
- [Free Waves' Audio Files](#) in RA & Wav

### **Radio 510 International**

- [Radio 510's Home page](#)
- [Radio 510's Relay Rates](#)
- [News from Radio 510](#)
- [Radio 510's IRRS Schedule](#)
- [Radio 510's WBCQ Schedule](#)
- [Listen to Radio 510's 1998 Special SWL Winter Fest Program.](#) - in RealAudio

## Swedish Report Service, SRS

- [Swedish Report Service Home page](#)
- [SRS "The Free Radio Page"](#) - Piracy info & resources
- [SRS Pirate news](#)
- [SRS Pirate sounds](#) - in RealAudio
- [SRS Technical Information](#) - transmitters
  
- [Various Pirate and Free Radio Bookmarks](#)



[|TOP|](#)[Antennas|](#)[AmDx|](#)[Clubs|](#)[Ham|](#)[Pirate|](#)[Rcvrs|](#)[UTE|](#)[Bookmarks|](#)[QSO|](#)[LogBook|](#)

# DX Clubs with News & Tips

[jump to Clubs: [B](#) - [C](#) - [D](#) - [E](#) - [G](#) - [I](#) - [L](#) - [N](#) - [O](#) - [R](#) - [S](#) - [U](#) - [W](#) - [Non-Club sites](#) - [Radio sites](#)]

## 425 DX News, Amateur Radio Bulletin

- [425 DX News, Bulletin Page](#)
- [425 DX News, Archive Search](#)
- [DX Calendar Page](#)
- [Links Page](#)
- [425 DX News, Italy, Homepage](#)

## Alberta/Manatoba Radio DX Club, AMANDX

- [AMANDX AM/FM/TV UNIDs Message Board](#)
- [Shawn Axelrod's North American XBAND List](#)
- [The GREAT WHITE NORTH Antenna](#)
- [Obtaining a QSL Verification from a Station](#)
- [Info on French and Spanish Pronunciation](#)
- [AMANDX Homepage](#)

## American Radio Relay League, ARRL - (Ham Radio)

- [ARRL Web Site Index](#)

- [ARRL Awards Program](#)
- [ARRL Technical Information Service](#)
- [ARRL W1AW Bulletins](#)
- [W1AW Schedules](#)
- [Hamfest and Convention Calendar](#)
- [Learn About Ham Radio](#)
- [American Radio Relay League Homepage](#)

### **American Shortwave Listener's Club, ASWLC**

- [DX SWL Programs](#)
- [Hot Spots Listening](#)
- [Shortwave Loggings from West Coast USA](#)
- [Your Special Listening Dates Calendar](#)
- [International Broadcasters list](#)
- [ASWLC club Message Board](#)
- [American Shortwave Listener's Club Homepage](#)

### **Araucaria DX Group, ADXG**

- [ADXG, Club News](#)
- [ADXG, Araucaria DX Group, Amateur Radio club, Brasil](#) - (in Portugese)

### **Asian Broadcasting Institute, ABI**

- [ABI's Asian Schedules page](#)
- [Asian Broadcasting Institute Homepage](#) - in Japan

### **Asociacion DX Barcelona, ADXB**

- [Frequency Lists](#)
- [Mondo DX Bulletin #215](#)
- [Noticias DX Bulletin #025](#)
- [Utility DXing Links](#)
- [Radio Stations Direct in RealAudio](#)
- [Radio Statio RealAudio Archive](#)
- [ADXB, Asociacion DX Barcelona, Spain, Homepage](#)

### **Asociacion Espana la de Radioescucha, AER**

- [EL-Dial Bulletin](#)
- [Emisoras International](#)
- [List of Shortwave stations using Realaudio](#)
- [AER, Asociacion Espanola de Radioescucha, Spain, Homepage](#)

### **Asociazione RadioAmatori Italiani, ARI**

- [ARI, Amateur DX Info Page](#)

- [ARI, DX News Page](#)
- [ARI, Associazione RadioAmatori Italiani, Italy](#) - (in Italian)

### **Association of Clandestine Enthusiasts, ACE**

- [ACE Home page](#)
- [ACE Loggings page](#)
- [ACE Articles and News](#)

### **Association of North American Radio Clubs, ANARC**

- [1999 ANARC Awards](#)
- [1999 North American DX Championships](#)
- [ANARC Club list](#) - with links
- [Dave Kirby's ANARC SWL Net Home page](#)
- [ANARC Homepage](#)

### **Assoziation Deutschsprachiger DX-er, ADDX**

- [ADDX Current Hour English Broadcasts](#)
- [ADDX Shortwave Schedules](#)
- [Radio Stations on the Internet](#)
- [ADDX Homepage](#)

### **Australian Radio DX Club, ARDXC**

- [ARDXC, Classified Page](#)
- [ARDXC, Australian Radio DX Club](#)

### **The Benelux DX Club - BDXC**

- [Benelux Homepages](#)
- [Benelux DX-Club "Monthly Bulletin"](#)
- [DX Programmes to Europe"](#)
- [English Transmissions to America](#)
- [English Transmissions to Europe](#)
- [WEFAX Information and Frequencies](#)
- [The Benelux DX Club Homepage](#)

### **British DX Club**

- [British DX Club's Articles Index](#)
- [British DX Club's DX Program Guide](#)
- [British DX Club's African Station List](#)
- [British DX Club Homepage](#)

### **British FM & TV Circle**

- [the "Skywaves" Bulletin](#)



- [CB and Amateur Radio Prefix List](#)
- [FM Receiver Reviews](#)
- [Latest DX Loggings](#)
- [Meteor Shower Calendar](#)
- ["On Screen" Long Distance TV Loggings](#)
- [British TV & FM Circle Homepage](#)

### **Broadcast Listening Club, BCNEWS, Italy**

- [Media News](#)
- [Audio Gallery](#)
- [QSL Gallery](#)
- [BCLNEWS, BCL News Club, Italy](#)

### **Canadian International DX Club, CIDX**

- [CIDX Bulletin, the Messenger](#)
- [Special Feature "Catch 26"](#)
- [Listen to the International Radio Report in RealAudio](#) - 1530 ut Sundays
- [Canadian International DX Club Homepage](#)

### **Central Florida Listeners Group, CFLG**

- [Disney World Frequency List](#)
- [Central Florida Repeater List](#) - (Zip file)
- [CFLG Upcoming Events](#)
- [Central Florida Listening Info](#)
- [CFLG Member Homepages](#)
- [CFLG Links Page](#)
- [CFLG, Central Florida Listeners Group](#)

### **Clube DX-ista da Amazonia, CDXA**

- [CDXA, Radio Station Recordings page](#) - (in MP3)
- [CDXA, Tropical Band Stations](#)
- [CDXA, DX Radio Programs](#)
- [CDXA, Receiver Reviews](#)
- [CDXA, DX Club List page](#)
- [CDXA, Clube DXista da Amazonia, Belem, Brasil Homepage](#) - (in Portugese)
- [CDXA's Loggings page](#)
- [Club DX-ista da Amazonia Homepage](#)

### **DXing with Cumbre**

- [Cumbre Dx Bulletin Archive](#)
- [DXing With Cumbre Radio Program](#) - in RealAudio

- [DXing With Cumbre Radio Schedule](#) - by Marie Lamb
- [DX Station Audio Samples](#)
- [QSL Gallery](#)
- [Special Edition News](#) - DX Items Too Hot to wait for the Newsletter
- [Club Babalu](#)
- [Cumbre DX Pagina en Espanol](#)
- [Cumbre DX Homepage](#)

### **Czechoslovak DX Club, CSDXC**

- [CSDXC, "DX Revue" Bulletin](#)
- [CSDXC, DX Publications](#)
- [CSDXC, Member Bandscans](#)
- [CSDXC, Technical Radio Schematics](#)
- [CSDXC, Czech DXer Email Address List](#)
- [CSDXC, Czechoslovak DX Club, Czech Rep. Homepage](#) - (in Czech)

### **Danish Shortwave Clubs Internationa, DSWCI**

- [DSWCI, Latest News](#)
- [DSWCI, Members Loggings](#)
- [DSWCI, Danish Shortwave Clubs International, Homepage](#)

### **Danish DX Listeners Club, DDXLK**

- [DDXLK, Tips and Loggings](#)
- [DDXLK, DXing Book Service](#)
- [25 Mhz Frequency list](#)
- [Local Radio in Denmark](#)
- [Pics from Radio limfjord](#) (for men only! Hi! Hi!)
- [DDXLK, DX Articles](#) - most in Danish
- [DDXLK Links page](#)
- [Nordic DX Championships Page](#)
- [Niels Holst's Homepage](#) - member
- [Peter Witten's Radio-siden Page](#) - member
- [DDXLK, Dansk DX Lytter klub](#) - most in Danish

### **DX Antwerp, DXA**

- [DXA's "DX MONITOR"](#) - DX News compiled by Mark Vissers
- [DXA's Shortwave Schedules](#)
- [DX Antwerp Homepage](#)

### **DX Clube do Brazil, DXCB**

- [DXCB, DX Articles Page](#)

- [\*\*DXCB, Loggings Page\*\*](#)
- [\*\*DXCB, Transmissions in Potugese\*\*](#)
- [\*\*DXCB, Utility Loggings\*\*](#)
- [\*\*Antique Radios in Brazil\*\*](#)
- [\*\*DXCB, DX Club do Brazil Homepage\*\*](#)

#### **DX Clube Paulista of Brazil, DXCP**

- [\*\*Logs Ondas Medias - BCB and SW loggings\*\*](#)
- [\*\*Onda Tropical - Tropical Band loggings\*\*](#)
- [\*\*DX Clube Paulista of Brazil Homepage\*\*](#)

#### **DX Listener's Club Norway, DXLC**

- [\*\*DXLC's "DX News"\*\*](#)
- [\*\*DXLC's Beacon List - LW to SW\*\*](#)
- [\*\*DXLC's "Solar Terrestrial Report"\*\*](#)
- [\*\*DX Listener's Club Homepage\*\*](#)

#### **Electronic DX Press, EDXP**

- [\*\*EDXP, List Archive\*\*](#)
- [\*\*Asia Link\*\*](#)
- [\*\*Bob Padula's Electronic DX Press, EDXP\*\*](#)

#### **El Dial, Spanish Listeners Club news**

- [\*\*EL Dial, AM BroadCast Band Loggings\*\*](#)
- [\*\*EL Dial, Shortwave Loggings\*\*](#)
- [\*\*EL Dial, Tropical Band Loggings\*\*](#)
- [\*\*EL Dial, Spanish DX Club News \(Spanish\)\*\*](#)

#### **European DX Council, EDXC**

- [\*\*EDXC, Conference page\*\*](#)
- [\*\*EDXC, Members page\*\*](#)
- [\*\*EDXC, European DX Council Homepage\*\*](#)

#### **Finnish DX Association, SDXL**

- [\*\*Raimo Makela's Tropical Band Station List\*\*](#)
- [\*\*Raimo Makela's Portable Shortwave Radio Reviews\*\*](#) - in Finnish
- [\*\*Radio Station Schedules and Frequencies\*\*](#) - in Finnish
- [\*\*Finnish DX Association Homepage\*\*](#) - In Finnish

#### **Federation of Mexican Radio Experimenters, FMRE**

- [\*\*Boletines Dominicales\*\*](#)
- [\*\*Como Ser Radioaficionado\*\*](#)

- [IARU Info](#)
- ["ESTACIÓN DX" Radio Program](#)
- [RED NACIONAL DE EMERGENCIA](#)
- [FMRE, Federation of Mexican Radio Experimenters Homepage](#) - (in Spanish)

#### **German Signal Search Ring, GSSR - UTE Monitoring**

- [Digital Sounds Page](#)
- [Frequency Lists](#)
- [Number Station logs and audio](#)
- [Hardware Projects and info](#)
- [Medium Wave Loop antenna](#)
- [Decoder Software](#)
- [GSSR, German Signal Search Ring Homepage](#) - (German & English)

#### **Grupa DX Mediterraneo, Medi DX**

- [Intro to Long Distance Medium Wave DXing](#)
- [Antennas Page](#)
- [Medium Wave Stations from Spain](#)
- [Medi DX, Grupo DX Mediterraneo Homepage](#) - (Spanish and English)

#### **Gruppo d'Ascolto Due Mari, GADM**

- [GADM, DX FanZine](#)
- [GADM, Shortwave, Community and Alternative Stations in Italy](#)
- [GADM, Shortwave Stations on the Internet](#)
- [GADM, Italian DX Vocabulary](#)
- [GADM, Gruppo d'Ascolto Due Mari, Italy](#) - (in Italian)

#### **Gruppo Radioascolto Liguria, GRAL**

- [GRAL, Cover Photo of GRAL "Media News" Bulletin](#)
- [GRAL, QSL Column 2000](#)
- [GRAL, Italian DX Club Links](#)
- [Mediterranean Media News](#)
- [Gruppo Radioascolto Liguria, Italy Homepage](#) - (in Italian)

#### **Hard-Core-DX**

- [Last 10 Articles posted to Hard-Core-DX](#)
- [Search Hard-Core-DX](#)
- [Britti-Dx, Tampereen DX Club Page](#)
- [Distance-On-Line DX Page](#)
- [DXing Links Page](#)
- [Freeze, DXing Artic Style Page](#)

- [Latin American DX](#)
- [Medium Wave DX](#)
- [NordicDX Center's Antenna Info Page](#)
- [NordicDX Center's Andes DX Page](#)
- [NordicDX Center's DXer's Lab Page](#)
- [HCDX SWB, Shortwave Bulletin Web Page](#)
- [DX Club of Tampere Web Page](#)
- [Hard-Core-DX Homepage](#)

#### **Indonesian DX Club, IDXC**

- [IDXC, Indonesian Shortwave Broadcastings](#)
- [IDXC, DX Diploma](#)
- [IDXC, QSL Images](#)
- [Indonesian Radio Web](#) by Nick Grace.
- [Indonesian DX Club Homepage](#)

#### **International Broadcasting Bureau, IBB**

- [IBB, Jamming Sounds page](#)
- [IBB, Frequency and Language Schedules](#)
- [VOA, Voice of America Homepage](#)
- [RFA, Radio Free Asia Homepage](#)
- [RFE/RL, Radio Free Europe / Radio Liberty Homepage](#)
- [Radio Marti Homepage](#)
- [IBB, International Broadcasting Bureau Monitoring Homepage](#)

#### **International Correspondence DX Group of Australia, ICDX**

- [ICDX Mailing List Info](#) - (on eGroups)
- [ICDX Bytes and Bits Computer Column Archive](#)
- [Selected News from "Crossfire", the ICDX Bulletin](#)
- [Selected Pacific AM BC Station News](#)
- ["Power Plant" ICDX Equipment Reviews](#)
- [International Correspondence DX Group Homepage](#)

#### **International Radio Club of America, IRCA**

- [IRCA's Hot BCB Tips](#)
- [IRCA and NRC CPC DX Tests](#)
- [International Radio Club of America Homepage](#) - medium wave only club

#### **Irkutsk DX Circle**

- [Local Broadcasting in Irkutsk area](#)
- [Utility Meteo DXing in the CIS](#)

- [Broadcasting in Russia](#)
- [Irkutsk DX Circle Homepage](#)

#### **JA-DXing in Japan**

- [Jembatan DX Bulletin](#)
- [Yokohama DXing Index](#)
- [Russian DX Page](#)
- [Listen Points News](#)
- [JA-DXing Homepage](#) - by Nobuo Takeno

#### **Longwave Club of America, LWCA**

- [Longwave Message Board messages](#)
- [LF Utility Stations Resource page](#)
- [LWCA Homepage](#)

#### **Medium Wave Circle, MWC**

- [MWC Publications/Reprint Service](#)
- [Intro to long distance MW listening](#)
- [DXing NAVTEX](#)
- [Medium Wave Circle home page](#)

#### **Michigan Area Radio Enthusiasts, MARE**

- [MARE, Mid East Situation Info](#)
- [MARE, Shortwave Broadcasters Schedules](#)
- [MARE, Sony 2010 Faq](#)
- [Michigan Area Radio Enthusiasts Homepage](#)

#### **Minnesota DX Club, MDXC**

- [Loop Antennas](#) - good resource
- [Winter Shortwave Frequency List](#)
- [Pavek Museum of Broadcasting](#)
- [Minnesota DX Club Homepage](#)
- [James Dale's Homepage](#) - MDXC host

#### **Mohawk Valley Shortwave Listeners Club**

- [MVSWLC Clandestine Page](#)
- [What in the World? Page](#)
- [Articles and Special Reports \(DX Camps\)](#)
- [Mohawk Valley Shortwave Listeners Club Homepage](#)

#### **Nagoya Dxers Circle, NDXC**

- [NDXC, Newsletter Index](#)

- [NDXC, Nagoya Dxers Circle Japan - \(in Japanese\)](#)

### **National Association of Shortwave Broadcast, NASB**

- [NASB, Newsletter](#)
- [NASB, Members](#)
- [NASB, Associates](#)
- [NASB, National Association of Shortwave Broadcasters](#)

### **National Radio Club, NRC**

- [NRC's International DX Digest directory listing - MW loggings](#)
- [NRC Publications and Reprints](#)
- [National Radio Club Homepage - medium wave only club](#)

### **New Zealand Radio DX League, NZRDXL**

- [DX Forums Page](#)
- [Links Page](#)
- [Links featured in the NZ DX Times Magazine](#)
- [DX Articles and Info Page](#)
- [Paul Ormandy's South Pacific DX Resource Page - good BCB DX resource](#)
- [NZRDXL, New Zealand Radio DX League](#)

### **North American Shortwave Association, NASWA**

- [NASWA's Journal Highlights](#)
- [NASWA's Shortwave Listening Guide - by John Figliosi](#)
- [North American Shortwave Association Homepage](#)

### **Ontario DX Association, ODXA**

- [ODXA's "Target Listening Guide" - by Harold Sellers](#)
- [ODXA's "Media Program Guide"](#)
- [ODXA's Sample columns page](#)
- [Ontario DX Association Homepage](#)

### **Play DX, DX News Magazine**

- [Play DX, DX Clubs in Italy](#)
- [Play DX, Private MW and SW Stations in Italy](#)
- [Play DX, RAI Stations on LW and MW](#)
- [Play DX, Medium Wave Station in Spain](#)
- [SWRS, Shortwave Relay Service Homepage](#)
- [Dario Monferini's "Play DX" Homepage](#)

### **Radio Rama, Italy's DX Magazine**

- [RadioRama, Web Site FAQ](#)

- [RadioRama, DX Radio Services](#)
- [RadioRama, RAI Stations in Italy](#)
- [RadioRama, World DX Station Lists](#)
- [RadioRama, Latin American DX Page](#)
- [RadioRama's Homepage](#)

### **Society to Preserve the Engrossing Enjoyment of DXing, SPEEDX**

- [Articles From Past Editions of SPEEDX](#)
- [Collection of DX Audio Files from Mauritius](#)
- [Daniel Sampson's Shortwave Broadcasts to North America](#)
- [DX and Other Interesting Programs List](#)
- [Interactive DX LogBook.](#)
- [DX QSO Link](#)
- [Tropical Band List](#)
- [SPEEDX Homepage](#)

### **Society of Osaka Radio Audience, SORA**

- [DX Reports](#)
- [DX Links page](#)
- [Members Homepages](#)
- [SORA, Society of Osaka Radio Audience Japan - \(in Japanese\)](#)

### **South Asia Radio Guide, SARG**

- [SARG, Radio News](#)
- [SARG, Frequency Database](#)
- [SARG, English Shortwave Schedules](#)
- [SARG, All India Radio Schedules](#)
- [SARG, South Asia Radio Guide Homepage](#)

### **Swedish DX Federation, SDXF**

- [SDXF's "DX-Relaterat" - Not in English](#)
- [SDXF's DX Tips board](#)
- [Swedish DX Federation Homepage](#)

### **SWL.NET, by Al Waller,**

- [Central Florida Listeners Group, CFLG](#)
- [Club Babalu Homepage](#)
- [Newcastle Scanner & Shortwave Group, NSG](#)
- [Radio China, All about radio in China](#)
- [Signal Surfer DX Club](#)
- [SWL.Net Master Index page - List of all the pages on swl.net](#)



- **Archive of [Recent postings on the SWL Mailing List](#)**
- **Subscribe to the [SWL Email List](#) - type **subscribe swl** in the message Body**
- **[Al Waller's QTH.NET Mailing Lists](#) - all the lists you could ever want!**

#### **UK Six Meter Group, UKSMG - (50 Mhz Radio Amateurs)**

- Check the [UKSMG 6m DXCluster](#)
- [6 Meter Audio Beacon List](#) - (listen in RealAudio)
- Listen to [6 Meters, 50110 Live with a FT650](#) From the UKSMG.
- [UKSMG Announcements Page](#)
- [UKSMG Six News Archives](#)
- [What is Six Meters](#)
- [UK Six Meter Group Homepage](#)

#### **Union Radioaficionados Espanoles, URE**

- [URE EA DX](#)
- [ENLACES A PAGINAS DE RADIO](#)
- [LOS SERVICIOS DE LA URE](#)
- [MATERIAL Y PUBLICACIONES](#)
- [URE, Union Radioaficionados Espanoles, Amateur radio, Spain, Homepage](#) - (in Spanish)

#### **Universal DX League, UDXL**

- [UDXL Dial Scan page](#)
- [UDXL DX News page](#)
- [UDXL WRTH Update page](#)
- [The UDXL's DX Grapevine \(Summer 97\)](#) - old but interesting
- [Universal DX League Homepage](#)

#### **Umeza Broadcast Listeners Club Japan, UBCK**

- [Communications Receivers](#)
- [Frequency Program Guide](#)
- [DX Links page](#)
- [UBCK, Umeza Broadcast Listeners Club Japan](#) - (in Japanese)

#### **WorldWide DX Club, WWDXC**

- [WWDXC, WorldWide DX Club "TOP NEWS"](#) - Compiled by Wolfgang Buschel
- [WWDXC's Previous week's "TOP NEWS"](#) - Compiled by Wolfgang Buschel
- [AGDX, WWDXC's Parent club](#)
- [WorldWide DX Club Homepage](#)

#### **WorldWide TV-FM DX Association, WTFDA**

- [FM Radio Related Web links.](#)
- [WTFDA Member Homepages.](#)

- [WTFDA "MailRoom" Page.](#)
- [Treasury Of Technical Articles.](#)
- [TV Related Web Links.](#)
- [WorldWide TV-FM DX Association Homepage](#)

### **WorldWide Utility News, WUN**

- [WUN File Archives](#) - Loaded with UTE monitoring Goodies
- [WUN Special Topics Reports Archive](#) - More UTE monitoring Goodies
- [WUN Newsletter](#)
- [IRC #WUN & #MONITOR chat Information](#)
- [World Wide Utility News Homepage](#)

[jump to Clubs: [A](#) - [C](#) - [D](#) - [E](#) - [I](#) - [L](#) - [N](#) - [S](#) - [U](#) - [W](#) - [Non-Club sites](#) - [Radio sites](#)]

## **Some Very Nice Non-Club Pages with DX News & Tips**

- [Sonny Ashimori's DX North Korea Page](#)
- [Hermon Boel's, "The World On Radio"](#) - DX News
- [Simon Collings' Radio Page](#) - (language recognition pages!)
- [English Shortwave Broadcasts to North America Page](#) - By Daniel Sampson
- [Sven Ohlsson's Shortwave Broadcast Schedules Page](#)
- [Eike Bierwirth's Radio Pages with SW Schedules](#)
  
- [Byron Hicks' Shortwave Radio Schedule Guide](#)
- [Hans van den Boogert's Radio China Homepage](#)
- [Literature of Shortwave Radio by Ed Janus](#) - Reviews of SWL Books (excellent!)
- [MondoRadio DX Club of Italy](#) - Italian Shortwave Resources Page
- [Paul Ormandy's South Pacific DX Resource Page](#) - good BCB DX resource
- [Listen to Paul Ormandy's DX Report on RNZI's "Mailbox" program in Realaudio](#)
- [Page 1700 Radio from DC to Light](#) Large collection of links
- [Raimo Makela's Tropical Band Station List](#)
- [Scan Cat Software and DXing files Page](#)
- [Klaus-Dieter Scholz's "www.dxing.de" DX Homepage](#)

### **Peter Costello's Shortwave/Radio Catalog**

- [Shortwave Catalog Index](#)
- [Shortwave Catalogue AM/FM Listening page](#)
- [Shortwave Catalogue Radio Services page](#) - (FAQs, Propagation, Clubs, etc)
- [Shortwave Catalogue Radio Topics page](#) - (Internet Radio, Scanners)

- [Shortwave Catalogue Satellite Radio page](#)
- [Shortwave Catalogue Shortwave page](#) - (Broadcasters, Ham)

### **Mark Fine's Fineware WWW page**

- [Mark Fine's Fineware link Homepage](#)
- [Mark Fine's SWBC Schedules](#)

### **George Jacobs and Association**

- [George Jacobs NewsFlash](#)
- [George Jacobs Station Schedules](#)
- [George Jacobs and Association Homepage](#)

### **Russian SWL and TV DX Page**

- [Russian Radio and Television Stations on the Internet](#)
- [Russian Radio and Television Stations list in Russian](#)
- [Russian Schedules](#)
- [Russian DX Publications](#)
- [Russian DX Clubs](#)
- [Whats New](#)
- [Russian SWL-Radio, TV and DX Page](#) - (in Russian)

### **Sven Ohlsson's DX Web Site**

- [Sven Ohlsson's English Home page](#)
- [Sven Ohlsson's English Schedules page](#)
- [Hialosa DX News](#) - by Sven Ohlsson
- ["Torget" DX News](#) - by Sven Ohlsson

### **Chris Ridley's DXers Toolbox**

- [Chris Ridley's DXer's Toolbox Home page](#)
- [How To... Page](#) - (Verify, SINPO, Projects, etc)
- [DX Theory Pages](#)
- [European and UK Frequency Pages](#) - Am, FM, LW

### **Tom Sundstom's TRS Consultants**

- [TRS Consultants Home Page](#)
- [TRS Radio Page](#) - Top Radio page
- [DX News page](#) - Good up to date DX News
- [TRS Events page](#)
- [IRC #SWL info page](#)
- [TRS Links page](#) - One of the Best!

## **Radio Station sites with News & Tips**

### **Radio Havana Cuba**

- [Arnie Coro's "DXers Unlimited"](#)
- [RHC's Homepage](#)

### **Radio Netherlands**

- [Real Radio Page](#) - with Receiver Shopping Reviews and Listening Tips
- [WRN, Radio Netherlands' "Media Network" Program Archives](#)
- ["Media Network" RealAudio Archive Page](#)
- [Radio Netherlands' Homepage](#)

### **Radio Sweden**

- ["Media Scan" Webpage](#) Communications Media News
- [Radio Sweden Homepage](#)

### **Voice of America**

- [VOA Programs in RealAudio Page](#)
- [WRN, VOA's "Communications World" Program Archives](#)
- [VOA IBB Monitoring Web Site](#)
- [VOA World Wide Web Home Page](#)

### **Glenn Hauser's "World of Radio"**

- [Glenn Hauser's "World of Radio" Web Page & Schedule](#)
- [WRN, Glenn Hauser's "World of Radio" Program Archives](#)
- [Glenn Hauser's SW/DX Report](#)

[jump to Clubs: [A](#) - [C](#) - [D](#) - [E](#) - [I](#) - [L](#) - [N](#) - [S](#) - [U](#) - [W](#) - [Non-Club sites](#) - [Radio sites](#)]



## **OUR COLLECTION OF DXING BOOKMARKS**

[|TOP|Antennas|AmDx|Clubs|Ham|Pirate|Rcvrs|UTE|Bookmarks|QSO|LogBook|](#)

## **Antenna, Propagation, and Tech Info**

## ***antenna info and projects***

- Archive of [Recent postings on the ANTENNAS](#) Listserver
- Directory list of [ANTENNAS listserver archives](#) in Digest format.
- [AntennaX Zine Homepage](#)
- [Antenna Elmer](#) - Wire antenna info
- [Ham Radio - Antenna](#) - Files
- [Amateur Radio A to M](#) - Files and Info
- [Amateur Radio Antenna Resource](#) - K3URT
- [ACTIVE ANTENNA for the Shortwave Region](#) - Good Construction Project
- [ARRLWeb: The ARRL Publications Catalog \(Antennas\)](#) - ARRL Info
- [ORION's Antenna Tech and Simulations](#)
- [AC6V's Homebrew Antenna Page](#)
- [Build your own T2FD antenna, Kees van Engelen, The Netherlands](#)
- [K3KY's Limited Space, Flags and Pennants Antenna Page](#) - for restricted areas
- [NordicDX Center's Antenna Info Page](#)
- [K6QGH's Homepage with Antenna Resource Links](#)
- [Phone Line as SW Antenna](#) - via Bill McFadden's page
- [Antenna Info and Projects](#) - on funet.fi
- [Index of /pub/ham/antenna/](#) - Finland's FUNET Info
- [A simple LONGWIRE Antenna](#) - on AMANDX website
- [Longwire Impedance Matching](#) - from BADX
- [The GREAT WHITE NORTH Antenna](#) - on AMANDX website
- [The DIPOLE Antenna / Info and Design](#) - on AMANDX website
- [Antenna Advice for UHF TV DXing](#) - on AMFMTV DX by Neil Kazaross
- [Discussion on BEVERAGE Antennas](#) - on USENET by G.Kipple
- [Myers Engineering International, Inc. Antenna Factors](#) - Names and Terms
- [Low Noise Antenna Connection](#) - from BADX
- [Grounding and FeedLine Info by John Doty](#) - on Delphi Web
- [Grounding Discussion](#) - from BADX
- [Review of ICE Matching Transformer](#) - from BADX
- [A Grounding System for Shortwave Listeners](#) - on AMANDX website
- [A Simple Anti-Static Device for your Antenna](#) - on AMANDX website
- [Bill's Ham Radio WWW Server](#)

## ***active antenna info***

- [Gary's Electronic Hobbyist Page](#) - w/Antenna Projects
- [R. Newell's Radio Resources, with Antenna circuits and designs](#)
- [Rainbow Kits ACA-1 Active Antenna](#) - for sale!
- [Naval Electronic Active Antenna MF-HF Reception](#) - for sale!
- [North Country Radio, Active antenna for portable radios](#) - for sale!
- [Ameco Corp products and services](#) - sells active antenna!
- [MFJ Enterprises, Inc.](#) - sells antenna accessories

## ***loop antenna info***

- [Loop Antennas](#) - via MDXC
- [Review of Radio Plus Electronics Quantum Loop](#)
- [Shawn Axelrod's 4 foot unamplified Box Loop design](#)
- [The AMANDX page with The BOX LOOP Info](#) - on AMANDX website
- [Bruce Carter's's AM Antenna Info](#)
- [Gerard's Tuned Loop Antanna](#)
- [LOOP Antenna Discussion](#) - on USENET by various postings
- [A Short and Easy MW LOOP Antenna](#) - on USENET by R.Hardin
- [Wakko's Radio Page/](#) - David Moisan's Carpet Loop Antenna
- [Antennas West Home Page](#)
- [Kiwa's Pocket Loop Page](#)
- [Joseph Cooper's BCB page](#) - with Passive Loop plans

## ***propagation info***

- [Propagation Basics](#) - on AMANDX website
- [Solar Terrestrial Dispatch Homepage](#)
- [Near-Real-Time MUF Map](#) - shows Greyline
- [Aurora Map](#) from the above site
- [Current Aurora belt picture](#) from uiowa.edu
- [Space Environment Center - Boulder CO.](#)
- [Space Environment Center's Radio User's page](#)
- [US Naval Observatory Astronomical Applications Department](#)
- [GeoClock's Home Page](#)
- [WWV Indices](#) - Current Flux count
- [WWV Realtime Indices](#) - current flux count

- [WWV Alert and Warnings](#) - current flux count
- [Last 25 WWV reports](#)

# Radio Receivers and Misc Listening Info

## *radio receiver info*

- [John Lloyd's collection of Shortwave RECEIVER Reviews](#)
- [John Lloyd's Reviews on PY2VHF's webpage](#)
- [Dave's Radio Receiver Page](#)
- [Receiver Shopping List](#) - via Radio Netherlands
- [Shortwave Receiver Info](#) - on funet.fi
- [Receiver and Antenna Reviews](#) - by Robert Kramer
- [Basic Receiver Specs Defined](#) - on AMANDX website
- [Collins R-390 Resource homepage](#) - by Chuck Rippel
- [R-390 Improved Audio Modification](#) - posted on USENET by Chuck Rippel
- [Posts about DX390 Static damage](#) - on rec.radio.shortwave
- [DX440/ATS803a resource Page](#) - by Jill Dybka
- [DX440 helpful Tips](#) - posted by JJ Hitt & Charles Mikelson
- [DX440 Mod for improved Gain using the Whip](#) - posted by Frank
- [Dave's Kenwood R-5000 User's Handbook](#)
- [GE SuperRadio](#) - by Werner Funkenhauser
- [David Moisan's GE SuperRadio FAQ](#) - a must read!
- [Joes Radio page](#) - GE SuperRadio
- [Sony ICF 2010/2001d 'FAQ' from MARE](#)
- [Sony 2010 filter mod](#)- on USENET by JR. Crabtree
  
- [Crystal Radios: Xtal Set Society](#)
- [Xtal Set Society Articles](#) - by Joseph Cooper
- [Build Your Own Crystal Shortwave Receiver](#)
- [Recent Posts about CRYSTAL RADIOS](#) - on AMFMTV DX list
- [Antique Radio Page: Articles - Build a "Foxhole Radio"](#)
- [military radio and Vehicle locator](#)
- [Boat Anchor resources](#) - on our Bookmarks page

## **receiver accessories info**

- [Accessories primer for the Beginner Listener](#) - on AMANDX website
- [Add-On BFO Project](#) - posted on USENET by Michael King
- [Another Add-On BFO Project](#) - on USENET by Hugo Caron
- [DXtreme Radio Software Web Site](#)
- [K0JD's Ham Homebrew website](#)
- [HARRY's HOMEBREW HOMEPAGE](#)
- [RFling Computers](#)
- [Rick's Modster Madness](#) - (DX440, YB400, DX398, etc)
- [Radio Mods from Oakland FTP Site](#)
- [Radio Mods from SUNY Buffalo FTP site](#)
- [Jamie Bucher's Radio Mods page](#)
- [QRZ.com's Radio Mods page](#)
- [AC6V's Technical Reference page](#)
- [AC6V's Radio Mods page](#)
- [Shortwave Converter Project by Bob Liesenfeld](#) - on qsl.net
- [Shortwave Converter Project](#) - on funet.fi
- [Build a Q-MULTIPLIER](#)
- [Build a CRYSTAL TESTER](#)
- [KB9JJA Heathkit Ham Radio Page](#)
- [MFJ Shortwave Products](#)
- [Helpful info about NICADS](#) - posted on the Scanner Echo by Bill Cheek
- [Sci.Electronics FAQ: Battery Info Menu](#)
- [Ramblings about NiCd Batteries](#)

## **web controlled receivers**

- [Listen to a FT747 and a Icom PCR1000 in Sweden!](#)
- [Listen to an Icom PCR1000 and a SRT CR91 in Norway!](#)
- [Listen to 2 Meter Repeaters in Wash DC area w/R7000!](#)
- [Chilton's R8 Shortwave Radio](#)
- [SW440 in New York State](#)
- [Java Radio Server Homepage](#)
- Listen to [6 Meters, 50110 Live with a FT650](#) From the UKSMG.
- [Police Scanner.Com, listen to various Police and fire](#)

- [\*\*DIGI and RTTY Decoder Information\*\*](#)



- [RTTY/FAX FAQ on Oakland.edu](#) by N1KGH
- [Packet Radio FAQ on Oakland.edu](#)

## ***miscellaneous listening info***

- [Radio Acronyms by Hugh Stegman \(3000+\)](#)
- [Introduction to Shortwave Radio](#)
- [Intro to LongWave Broadcast Stations](#) - on AMANDX website
- [The DXer's Toolbox](#) - with Basic DX info
- [The Literature of Shortwave Radio](#) - Excellent Shortwave Book Reviews
- [Obtaining a QSL Verification from a Station](#) - on AMANDX website
- [Info on French and Spanish Pronunciation](#) - on AMANDX website
- To convert to UTC time, [try this Univ of Illinois page!](#)
- [PLUG IN Music Reference Guide and Info](#) - WorldWide Music Charts
- [Caravan Music's Guide to Latin Music](#) - Audio Clips
- [Cuban Music Samples](#) - Audio Clips
- [La Romana On-Line Dominican Music Samples](#) - Audio Clips
- [the Sounds Of Shortwave](#) - Audio Clips
- [Welcome to Tiare Publications](#)
- [Monitoring Times](#)
- [Popular Communications](#)
- [Index of FTP.FUNET.FI:/pub/ham area](#) - Top FUNET menu page
- [QRZ.com's Ham Files Download page](#)
- [Index of /pub/hamradio/oak/arrl/bbs](#) - Top ARRL menu page
- [IRCA Bookstore and Reprints](#)
- [NordicDX Center's DXer's Lab Page](#)
- [NRC Publications and Reprints](#)
- [The Medium Wave Circle](#) - Publications/Reprint Service

## ***miscellaneous info and Articles***

- [A Visit to BBC's Hong Kong Relay](#) - posted by Richard Buckby

Use [DEJANEWS](#) to search for USENET messages

I pick-up the FIDO NET SW-Echo from Fred Hatfield's DIGITAL COTTAGE BBS. (504-897-6614)

[|TOP|](#)[Antennas|](#)[AmDx|](#)[Clubs|](#)[Ham|](#)[Pirate|](#)[Rcvrs|](#)[UTE|](#)[Bookmarks|](#)[QSO|](#)[LogBook|](#)

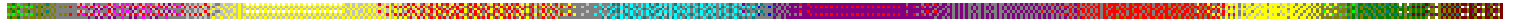

## Some of the Interactive Pages on this site

The DX QSO LINK is an interactive message page for the exchange of radio and DX information. You could try calling CQ someone may come back to you. If I'm on at the same time, we can talk.

For the informal sharing of UTE DX information! Also used as a supplement to our [Internet DX LogBook](#).

For notification of SKIP OPENINGS and PROPAGATION ALERTS! Many radio amateurs visit this page every day.

Please [submit](#) a LOGGING to our LOGBOOK!

## *Other Interactive pages and Lists on this site!*

[DXProp](#) | [VHF QSO](#) | [MS Rocks](#) | [BCB Prop](#) | [UTE Log](#) | [QSO Link](#) | [DX Talk](#)

[DXPrograms](#) | [ADDX List](#) | [TropList](#) | [BCBDXList](#) | [Hurricane List](#) | [UTE List](#)

Please feel free to try out and use these pages!!!



- [16 Bit Netscape 4.08 \(Win3.1\)\(8880k\)](#)
- [32 Bit Netscape 4.08 StandAlone \(Win95/NT\)\(9968k\)](#)
- [FTP site w/Recent Netscapes available here](#)
- [32 Bit Netscape 3.04 \(3430k\)](#)

*Although we have made every effort to ensure the reliability of our sources, we do not assume responsibility for their accuracy. Standard disclaimer applies!*



[Return to the Shortwave and DXing Homepage](#)

[TOP](#)|[Antennas](#)|[AmDx](#)|[Clubs](#)|[Ham](#)|[Pirate](#)|[Rcvrs](#)|[UTE](#)|[Bookmarks](#)|[QSO](#)|[LogBook](#)|



Number of hits on this page since Nov 5th:

(Load this image to be counted.)



[TOP](#)|[Antennas](#)|[AmDx](#)|[Clubs](#)|[Ham](#)|[Pirate](#)|[Rcvrs](#)|[UTE](#)|[Bookmarks](#)|[QSO](#)|[LogBook](#)|

© 2000 Bob's Radio Web

# DXing.com

## Joe Carr's Tech Notes

### [Home](#)

### Up Front

[Newsroom](#)

[Editorial](#)

[E-Letters](#)

### Features

[Glenn Hauser's  
SW/DX Report](#)

[Glenn Hauser's  
Continent of Media](#)

[Don Schimmel's  
Radio Intrigue](#)

[Joe Carr's Tech Notes](#)

### Radio Basics

[Frequency vs.  
Wavelength](#)

[Modes and  
Modulation](#)

[Call Sign Prefixes](#)

[UTC/GMT Conversion](#)

Noted author, **Joseph J. Carr**, has created a series of short articles on topics of interest to the shortwave listener. Universal Radio Research is pleased to provide them here in PDF format.

#	Title	Pages
01	<a href="#"><u>Directional or Omnidirectional Antenna?</u></a>	7
02	<a href="#"><u>What is a "Good Ground"?</u></a>	6
03	<a href="#"><u>Connecting Your Receiver to the Antenna</u></a>	6
04	<a href="#"><u>Installing Coaxial Connectors</u></a>	4
05	<a href="#"><u>Connecting the Transmission Line to the Antenna</u></a>	5
07	<a href="#"><u>Filter, Attenuator, Preamplifier, Preselector --- or Barefoot?</u></a>	10
08	<a href="#"><u>Small Loop Antennas</u></a>	7
09	<a href="#"><u>Using the Small Loop Antenna</u></a>	8

If you enjoy Joe's clear and informative writing style and would like to learn more about shortwave antennas we recommend . . .

[Radio Terms](#)

## Shortwave Radio

[Introduction to Shortwave Listening](#)

[Tuning 150 kHz to 30 MHz](#)

[Selecting a Shortwave Radio](#)

[Reporting and QSLs](#)

## Receiver Reference

[Modern Shortwave Receiver Survey](#)

[Favorite Tube-Type Shortwave Receivers](#)

## Scanner Monitoring

[Introducing the "Action Bands"](#)

[The World Above 30 MHz](#)

[Selecting a Scanner](#)

[National Scanner Frequency Guide](#)

## Other Radio Hobbies

[Ham Radio](#)

[AM Band DXing](#)

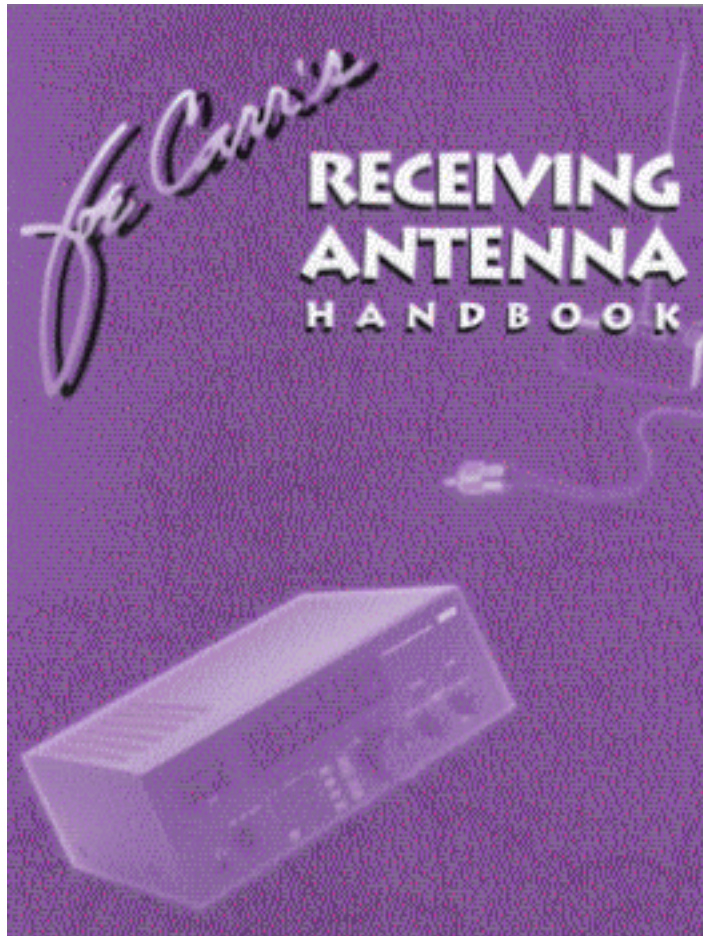

# Joe Carr's Receiving Antenna Handbook

**By Joseph Carr**

This guide to high performance antennas is written in Joe's clear, easy to understand, friendly style. Arguably the best book devoted to receiving antennas for longwave through shortwave. An excellent book for the shortwave listener who likes to experiment with different antennas. ©1993 Hightext 189 pages.

**Only \$19.95**

Available from Universal Radio and other select radio and book dealers.

[Click here to visit Universal Radio's online catalog.](#)

[Longwave DXing](#)

[Clandestine Radio](#)

[Pirate Radio](#)

[Numbers Stations](#)

[TV/FM DXing](#)

## **Radio Links**

[Shortwave Listening](#)

[Radio Clubs](#)

[International  
Broadcasters](#)

[Scanner Listening](#)

[Ham Radio](#)

[Web-Controlled  
Radios](#)

[Miscellaneous](#)

[Top of Page](#)

---

**©1999-2004 by Universal Radio Research. All rights reserved.**

Choose units for **a** , **h** and **w**

**meter    cm    inch**

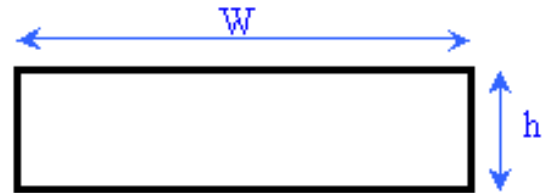

**Parameters — Input**

**N**    —    **turns**

**w**    —

**h**    —

**a**    —

**μr**    —

—    **nH**

—

- **N**: number of turns
- **w**: width of the rectangle
- **h**: height of the rectangle
- **a**: wire radius
- **μr**: relative permeability of the medium

$$L_{rect} = N^2 \frac{\mu_0 \mu_r}{\pi} \left[ -2(w + h) + 2\sqrt{h^2 + w^2} - h \ln \left( \frac{h + \sqrt{h^2 + w^2}}{w} \right) - w \ln \left( \frac{w + \sqrt{h^2 + w^2}}{h} \right) + h \ln \left( \frac{2h}{a} \right) + w \ln \left( \frac{2w}{a} \right) \right]$$



# Loop Antennas

[Home](#)[Minnesota DX Club](#)[Altered Photos](#)[Pavek Museum](#)[PVC Loops](#)[Links](#)[E-Mail](#)[Up](#)

## Loop Antennas

[Summer List](#)

The Principles of the Loop Antenna article was in a newsletter of the MDXC. The next three were from a talk that Mike Bates and James Dale gave to the Northland Antique Radio Club's Radio Workshop at the Pavek Museum of Broadcasting.

[Winter List](#)[Loop Antennas](#)

### [What is a Loop and Why Use It](#)

[TV/FM DXing](#)

### [Construction Principles](#)

### [What Can I Use a Loop For](#)

### [Loops Another Look](#)

### [Pictures of Home Built PVC loops](#)

### [Loop Links](#)

---

## Principles of the Loop Antenna

A loop antenna is an antenna primarily for the AM broadcast and the Longwave bands. There are two different types of loop antennas, one is the ferrite bar (as in your am radio), the other is wound on an air core form. A loop antenna is very directional. The pickup pattern is shaped like a figure eight. The loop will allow signals on opposite sides to be received, while off the sides of the loop the signal will decrease or be nulled out. The nulling feature will allow you to remove a local station on a frequency and pick up another on the same frequency by removing the local signal. A loop may have an amplifier or may not.

Air core loop antennas come in many sizes. The larger the loop the more gain there is. A small loop will actually lose part of the signal. That is why most small loops will use an amplifier. There are two ways a loop can be wound, box or spiral. In the box or solenoid loop the plane of the winding are wound perpendicular to the diameter of the loop, so each loop is the same size. In the spiral loop the plane of the windings are wound parallel with the diameter of the loop, so each loop gets smaller as you wind into the center of the loop. A loop needs to be able to rotate to null out

a station. And a loop also needs to be able to tilt from vertical. This also helps in nulling of a signal (altazimuth feature).

The number of turns the loop needs is determined by the size of the loop, the frequency range that you want to tune and the value of your tuning capacitor. The larger the loop the fewer turns you will need. A 4 foot loop needs 8 turns and a 2 foot loop needs 18 turns. The capacitor that is used is the standard AM tuning capacitor with a range of 10 to 365 pf. The tuning capacitor is used to tune the loop to the frequency that you want to listen to. When you are tuned in to the frequency the signal will peak. You may not be able to tune the full frequency range that you want to tune. So you will need to use a 2 section capacitor and switch the second section in. (more capacitance)

### **There are three ways that you can connect your loop to your radio.**

One way is not connecting it at all. (This requires a portable radio with a internal loop antenna.) The field of the loop will radiate the peaked signal and you will be able to pick it up with no connection to the radio. You can move the radio around to get the best reception.

You can also direct couple to the loop. This way you connect to each end of the loop and also to the center tap of the loop. Using this method you will need to use it with an amplifier.

The last method is to use a pick up coil. This consists of one turn of wire that is placed inside the loop on the cross arms. This is then connected to the radio. The distance from the main tank coil can be determined by using a pocket radio and moving it inside the loop to find the place where the signal is strongest, and where it peaks sharpest.

In the past loops were made from wood. I have built them and found them to be heavy, clumsy, and flimsy. The mounting system were not very stable. In talking with Mike Bates, he came up with the idea of using PVC to build loops. PVC is easy to cut and because you use PVC molded parts, the loop that you make are stable. By using PVC cement for some gluing and small nylon screws to connect parts you have no metal parts except the wire and tuning cap to throw the pattern of the loop off. Using PVC it helps to have a drill press, but if a person drills very carefully there should be little problems.



[Back to the top](#)

---

## **What is a loop and why use it?**

1). A loop antenna is a small multi turn loop of less than 1/10th wavelength in length. The loop is wound on a form, which may be either box (solenoid), or spiral (pancake) wound. The core material can either be air, or a powdered iron compound (Ferrite). The gain of a loop is much less than a longwire, but it has much less noise

pickup. A properly designed Loop primarily responds to the magnetic component of the radio wave. Note that noise resides primarily in the electrical component. A vertical antenna responds mainly to the electrical component.

## 2). Why use a loop?

- A). No available space for a longwire antenna
- B). To eliminate unwanted signals, and noise
- C). Radio Direction Finding
- D). To improve the performance of a simple receiving system, by providing pre-selection which improves image rejection, and adjacent channel selectivity.

## 3). History

A) 1915-1920's Early receivers used loop antennas, until they were discontinued in favor of long wire antennas, prior to 1930.

The loop antenna appeared again about 1938. This time it was used to eliminate the need for a longwire antenna, and to provide for safer operation of the small midget AC/DC sets that came into wide use at that time.

B). The first known use of a high performance loop antenna is the box loop made by Ray Moore in the mid 1940's(1) This antenna was written up in DX Horizons in 1960. The Moore Loop was wound on a 40" square box frame. Note: Ray Moore is the Author of the book on the history of Communications Receivers, and a new companion book on Transmitters.

C). The next major advance in Loop Antenna design came about as a result of advances by Gordon Nelson of the National Radio Club. The NRC Loop Antenna(2)was designed by Nelson in the Mid to Late 1960's time frame, Nelson was at M.I.T. at the time. The major advance that Nelson made was allowing the loop to rotate in the vertical as well as horizontal plane. The addition of the Alt-azimuth adjustment allows for the elimination of the effects of "wave tilt" and allows for much deeper nulling of certain stations. This loop was a 35" on a side and wound on a wood frame. In one form it utilized another Nelson first, a direct coupled Balanced amplifier using 2N4416 J-FET's with the outputs fed to a balanced feedline. The other version was link coupled to the receiver.

D). Sanserino Loop (1970-1985) This is a 2 foot Air core box loop designed by Ralph Sanserino, and later marketed by Radio West. This loop antenna used a Differential Amplifier similar to Nelson's except the output is not balanced. This antenna also has the Alt-azimuth feature. (available as a kit) The amplifier was later used in the Radio West Ferrite Loop Antenna (see below) .

E). Joe Worchester (1970-1977) a retired GE engineer developed the "Space Magnet ", a small 12" ferrite rod loop antenna using a Bipolar Junction Transistor amplifier(3). Nulls were not as deep as with the Nelson Loop. This is also probably the first loop antenna commercially available to the hobbyist, at a cost of about \$45.00 if I remember correctly. Later versions utilized the Nelson Alt-azimuth

feature. This antenna also used a Faraday Shield around the Ferrite Bar.

F). Mackay Dymek (1974-Early 1980's) , Palomar Engineers (1977-current). These are small ferrite antennas made by larger commercial concerns. The Mackay Dymek was primarily for the Broadcast Band, where the Palomar has plug in coils for ranges from 10Khz to 15Mhz. Note that both of these antennas incorporated alt-azimuth design.

G). Radio West(1979-1985) 23" ferrite rod assembly using Sanserino Differential Amplifier, direct coupled, Has Alt-azimuth feature, \$160.00 in 1979.High performance for its day, quieter than the "Space Magnet"

H). Quantum Loop (about 1990) by Gerry Thomas is a small ferrite rod less than 1' in size (length), with a high gain 40Db amplifier. has Alt-azimuth feature, in current production in various forms \$135-\$200.00.

I). KIWA Loop 1992 First Air core available since Nelson/Sanserino. Uses IC amplifier Opto isolated regeneration and varactor tuning. High performance, solidly built, in current production. \$360.00.

J). RSM Communications (Ray Moore) RSM-105 (1994) A high performance transformer coupled, non amplified antenna described by Moore in Dec 1994 IRCA DX Monitor, Later in March 6 1995 issue of NRC DX News. Still in production? Price?? 35" spiral wound.

#### **4). Electrical Design Characteristics**

A). Two main types of Loops available 1). Directly Coupled and 2). Indirectly coupled (Transformer coupled) The Directly Coupled Loop has its windings directly attached to an Amplifier. Usually the main Tank Coil (parallel tuned circuit that forms the loop primary) in the loop is grounded at the center of the winding (center tapped), to allow for electrical balancing. The Amplifiers are usually but not always J-FET's, with 2 FET's in a Differential configuration, where the ends of the tank winding go to each FET gate. The Transformer coupled version uses a link winding to couple the signal to the receiver. This version can be amplified or non amplified.

B). The pick up pattern of a properly designed loop should be a figure 8 pattern. The null should be of the same depth, if the antenna is rotated 180 degrees horizontally (loop should not be adjusted for alt-azimuth, but left vertical 90 degrees from the ground). The 180 degree symmetry should be the same + or - one degree. If this condition does not occur the Antenna is not properly balanced. In a transformer loop balance deals with the signals being equal on both lines of the feed line (equal potential to ground). The feed line should preferably be shielded with the shield being grounded to the receiver chassis. If the line is affected by an electric field signal, a metallic object, or some other imbalance to ground, the loop will become unbalanced, resulting in a distortion of its pick up pattern. Balance is critical to getting the best nulls, and for precision Radio Direction Finding. The use of a broadband balun allows for better balance, but thought should be put into the design of the link winding, and receiver feed line, as well as the mechanical integrity of the coil.

C) The transformer coupled loop is the easiest to balance, especially if it is an air core loop. Ferrite loops are not as easy to balance due to the compression of flux

lines in the ferrite. These antennas seem to be somewhat more prone to pick up electric fields.

D). In a directly coupled loop, the balance is affected by the gain of the amplifying devices on either side of the center tap being equal. If they are not very close to, or equal, they will cause the voltage in the tank coil to be imbalanced with respect to ground causing the same undesirable effects that the feed line caused in a Transformer Loop.

E). Some loops utilize a Faraday shield to maintain balance (4) Usually a one turn loop. these are usually circular, and are used on ships and other areas where direction finding is necessary. An example of this antenna is the 160 meter loop wound out of coax described by Doug DeMaw (5) Using a Faraday Shield will affect the pick up gain, as well as the "Q" of the tank coil(3) Another variant of the shielded loop is the Mike Hawk Loop(6)

Also note that imbalance is sometimes referred to as "Antenna Effect"(4) Also please note that a balanced loop antenna can be spoiled to a cardioid pattern by putting a vertical sense antenna within its field. (4)

F). The amount of coupling (placement of the link turn) is critical to the performance of the Transformer Coupled Loop. The placement can vary depending upon the load that the antenna sees. The best way to obtain optimum performance is to experiment with various distances from the Tank Coil. Most designs call for this to be wound amongst the tank coil windings, however this coupling is much too tight for most uses, and allows for tuning to be too broad, Q to be too low, and sensitivity to be not quite optimal.

G). The physical size of the Loop Tank Coil affects the overall pickup (capture ability) of the loop. The larger the winding size the greater the pickup. Larger loops will also be easier to balance than smaller ones.

H). The Tuning Sharpness "Q" is determined by the size of the wire (surface area). The lower the resistance the higher the "Q" will be. The loading of the Tank Coil also affects the "Q". This more than wire resistance affects the Transformer Coupled Loop. In a Transformer Loop, the placement of the Link Coil in relation to the main tank (distance) determines the amount of coupling, and hence the loading of the tank circuit. The point of critical coupling can be found by varying the coupling link distance, while comparing tuning sharpness and gain. the critical coupling point will be found at the sharpest tuning before the gain starts to drop. Tuning will continue to sharpen (slightly), but gain will fall off more rapidly, as one couples more loosely (moving the link physically farther from the Tank Coil). Further improvement can be had by matching the load impedance to the link coil with a matching transformer. This can be done as part of a balun, or following the balun (lead-in side). For optimum performance all impedance's in the system should be properly matched.

I). The L/C ratio and mechanical design of the coil should be considered when looking at a good design for a loop. The loop should be mechanically stable (wires not flopping loose) The distributed capacitance between turns should be kept low by proper design to allow for wide tuning range, but not too wide to degrade the length to diameter ratio of the coil. Note that the best null performance occurs with the best length to diameter ratio of the Tank Coil. A spiral wound coil affords the best performance in this regard, but does not afford as great a signal pickup as a

solenoid coil of the same diameter. (A Trade off)

Also note that the L/C ratio should allow for one 10 to 500pf variable capacitor to tune the whole Medium Wave Broadcast Band. (530-1700 KC)

J). Performance can be further enhanced if the amplifier following a transformer coupled loop is tuned. This provides still better image rejection, and adjacent channel selectivity. It is important that the amplifier be isolated from the loop by a transformer to maintain balance and pattern integrity.

K). Note that the spacing of the windings determines the inter-electrode capacitance. The wider the spacing between windings, the lower the capacitance, and the higher in frequency the loop will tune. the use of interlaced spreaders further reduces this effect (solenoid loop) provided that the spreaders are of sufficient width. Also note that the winding spacing is a compromise with the length to diameter ratio.



[Back to the top](#)

---

## Construction Principles

### 5). Mechanical design

A). Up to now, loops were made from wood. It was used because it was readily available and easy to work with. Wood does have disadvantages. They are, finding good wood, making accurate cuts, and heavy weight.

B). In a wood loop, the alt-azimuth tilting mechanism does not work very well. Wood loops use a bolt for the alt-azimuth tilt. It uses an arm that goes from the loop to a clamping setup on the mounting post. This does not work very well, as you need to tighten the bolt every time that you change the vertical tilt. The bolt will become loose, and on high angle tilts does not hold very well.

C). Most loops use a pipe mounted vertically with a dowel to do the horizontal rotation. This does not work well, as it allows the loop to move on it own. Wood will also wear after some use. This allows the loop to lose its square ness which can affect the loops pick up pattern.

D). The first loop I built was the Harley Loop(7). It is small spiral loop that was easy to build, but had no Alt-Azimuth feature, so the loop would not vertically tilt. It uses two cross arms with saw kerfs part way through to hold the wire.

E). I then built the 4 foot NRC Loop(2). This loop worked well, but the Alt-azimuth tilt needed work so I did some modification on the tilt mechanism. I wanted to design a tilt that would be easy to tilt and would stay in place. I tried different ideas and in my design I used a 3 inch PVC pipe for the mast and the loop head would tilt off that, this did work better but was not perfect.

F). While talking to Mike Bates(1995) about loops, He had the idea to build a large spiral octagon loop(5ft), out of PVC pipe and Alt-azimuth tilt it with a tripod. We built the loop, and this got my interest in using PVC for designing and building loop antennas. The tripod did not work very well due to the heavy weight of the loop head, but the performance was quite good.

G). My next design was a 4 foot PVC spiral loop that is collapsible. New features added to this loop was the use of a lazy susan for the horizontal rotation of the loop, however, you need to use a liberal amount of grease to give it tension. For alt-azimuth tilt I took a 3/4 inch PVC tee, reamed out the inside smooth, and cut a slit length wise. Through this I ran a piece of PVC pipe and with the use of elbows and tees attached it to the loop head. I then used plastic hose clamps to adjust the tension. This worked better, but still did not work very well. It is hard to get the angle just right, it does not move smooth enough.

H). Then I built a 4 foot Loop modeled from the NRC plans(2) out of PVC. For this loop I added the use of PVC in the base. I used the same type of Alt-azimuth tilt mechanism as the earlier spiral. To mount it to the loop head, I used a hole in the crossover of the loop to attach to the alt-azimuth mount. This was done to allow for having the ability to build different loop heads, like one for the longwave beacon band. This allowed the loop head to rotate on the mounting mechanism which made the loop unstable, and not very easy to use. I decided to make the mounting like the spiral loop, but to add the tees, I needed to cut part of the tee to mount it on the loop arms. When I assembled it for fit, I found out that cut out tees worked much better for tilting, and hose clamps are no longer needed. The alt-azimuth tilt mechanism now works very smooth and holds well at all angles.

I). The 2 foot loop was also built based on the NRC plans(8), it employs a gimbal mount for alt-azimuth tilt.

J). These loops are made entirely out of PVC except for the base plate that employs a lazy susan to rotate the loop. I built jigs to drill the holes in the cross pieces. A drill press helps a lot, but with very careful measuring and drilling, a hand drill may work. In my first loops I used PVC cement to glue the loops together. This cement sets up very fast, so you have to be very careful assembling it. I found out that some parts can be glued, but on some it is better to use a small nylon screw. This allows for you to align the pieces right on. To do this drill and tap a hole for the screw and run it through both pieces of plastic (PVC).

K). It helps to make a jig to wind the tank coil onto the frame. To accomplish this I mounted a Lazy Susan to a board, and ran a board with two vertical pieces of PVC Pipe The loop frame slides over the pipes, allowing the loop to be rotated while the wire is brought off of the spool in the same direction, while being laced through the holes in the frame. This helps greatly, in minimizing twisting of the wire.

L). Reasons for using PVC in loop construction:

- 1). Readily available, at low cost
- 2). Easy to work with, Saw and drill are main tools required, however, a miter box saw allows for clean perpendicular cuts.

- 3) Very symmetrical loops can be built, because the fittings are identical, and pre made.
- 4). Very low weight
- 5). The ability to come up with modular designs
- 6). The ability to design a collapsible loop that can be mechanically strong, allowing for easy transport
- 7). The use of spacers will tighten up the wires, so that they do not flop around, and distort the pickup pattern, as well as reduce inter-electrode capacitance. This makes for a very stable loop.

M). Notes:

Loop shapes: Triangle (Wedge), Square (Also called box, this is the most common shape) Octagon, Circular.

Note that the box loop is used because it is the simplest to build. The circular loop provides the nearest to the perfect shape electrically, but it is very difficult to fabricate a multi turn loop of this type. The octagonal loop is the practical compromise. Also note that the Octagonal is more difficult to fabricate due to it having 8 arms instead of 4, for the box loop.

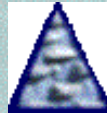

[Back to the top](#)

---

## What Can I use a Loop For

### 6). Using the Loop practical applications

The small loop is a versatile antenna, and can be used for many different applications, here are a few.

A). The loop can be used for improving the performance of a poorly designed broadcast receiver. Depending on the type of antenna that is in the receiver determines how the loop can be attached. It may be attached via a transmission line if the set has wire or screw binding posts for the Antenna, or it may be inductively coupled (transformer) for a receiver using a very small loop. In the case of the receiver with a small loop the coupling rules apply as if the receivers loop is the link turn in the Transformer loop. (Note that the link coil is not needed for the loop to work for this, as the internal loop in the receiver is receiving the signal from the main tank circuit). The distance from the receiver to the larger loop will determine the amount of coupling, and tank loading. One can vary the pick up pattern by varying the angle of the receivers internal antenna to the external loop. The antennas provide maximum transfer of signal, and closest to a figure 8 pattern. when the pick up angle of the antennas is opposite parallel (90 degrees) (Beams of



the antennas aimed at each other) Minimum pickup occurs at 180 degrees. The pattern can be spoiled to a cardioid (null in only one direction) by varying the angle. Please note that the pattern will probably be somewhat spoiled from a figure 8 at the maximum signal 90 degree points. Please note that there are 2 commercially available products designed to inductively couple to the receiver, and improve its signal. These are the "Select A Tenna", and the "Q Stick" by Radio Plus (Gerry Thomas). However a 2ft or larger loop provides for much better performance provided one properly adjusts the coupling. A Large loop (4 ft) can cause a poorly designed receiver to overload. Loosening the coupling will allow for the overload to be eliminated. One must also be sure for proper operation that the loop is tuned to the same frequency that the loop is tuned to, or unwanted overload effects will likely be noted. All tuned circuits should be "aligned" to the same frequency. Also note that high Q tuned circuits can sometimes be touchy to adjust "spot on", some practice will probably be necessary. One can be amazed at the improvement in performance when using a properly designed loop. Stations can be brought from out of nowhere on a poor set. Images at the low end of the broadcast band will be cut down significantly or completely eliminated. As stated previously, adding a properly designed tuned amplifier further improves the performance of the system. The amplifier can be fed by feedline to a coupling link that couples to the receivers internal loop, or can be direct attached to a receiver with antenna connections.

B). A loop when properly balanced can be used to "null down" AC Line noise, TV Sweep Harmonics, or other locally generated interference. The Alt-azimuth feature helps greatly reduce, sometimes totally eliminating the noise. This feature is also quite useful for nulling of co-channel, or adjacent channel broadcast band stations. If properly balanced, nulls of over 60 dB may be attained by using the Alt-azimuth feature. Deep nulls can be difficult to find and maintain. A larger antenna allows for one to find the null more easily due to the larger pick up(field) created by the loop. Loops of 2 ft and smaller in diameter, can be quite touchy to null, and electrical balance can be quite hard to attain. Hand capacitance can also affect the null in these small loops, causing the null to move as ones hand is moved away. This effect is minimized when using a large loop, as your whole body is within the pick up pattern of the loop, and it will be less likely to distort the pattern. One needs to be 6" to 1' away from the small loop(2ft and smaller) to avoid the hand capacity effects. It is also notable that nulling works best on local ground wave signals. Distant sky wave signals can be more difficult to null. It is difficult to get a null of greater than 30 dB on a sky wave signal at the top end of the broadcast band at night. For Sky wave, phased antennas provide for much better nulling, but are much more complex, and difficult to operate. Also note that the higher the Q of the tank coil, the sharper the null. Sometimes the null will be excessively sharp, and difficult to find, or the null will be so narrow in bandwidth that the carrier of a station will be deeply nulled, but the sidebands will be well received as slop(splash). This affect is more noticeable in small, or amplified direct coupled loops.

### C). Radio Direction Finding

One can accurately direction find signals provided that the antenna is properly balanced as described above. The general concept is that the deepest null will be in the direction of the signal being checked. You cannot use the Alt-azimuth feature, you must keep the loop perpendicular 90 degrees to the ground. An accurate compass, and a marked 360 degree circle can be used to pin point the exact bearing that the signal is coming from.

Bibliography from the three articles above can be found at the bottom of this page.

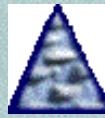

[Back to the top](#)

---

## Loop Antennas Another Look

The last 30 years have brought about much refinement in the design of loop antennas. Starting from the basic box loop described by Ray Moore, major developments over this time are; The NRC 4ft Alt-azimuth loop, the Space Magnet, Sanserino Loop, Palomar, Mckay Dymek, Radio West, Quantum, Lankford, Kiwa, and RSM 105, and 103. As time has progressed, so has the design of Receiving Equipment, from the R390A, HQ-180, and SX-122 and Zenith Trans-Oceanic to the Sony 2010, Drake SW-8, Drake R8-B, and the AOR7030 Plus. Antenna needs have changed, with today's broadband front ends, and synthesizer phase noise a concern, a high performance loop, or other means of pre-selection is more important than ever.

We will show a slightly different twist on the same basic loop antennas of the past, with a couple of refinements, as well as construction details of our antennas.

To explain our antennas we want to start with the design criteria necessary to improve the modern communications receiver, as well as consumer grade radios such as, the Super Radio III, the Radio Shack Optimus, and most other portable short wave/broadcast receivers.

Important loop criteria have been explained before in the pages of DX News, and the NRC Antenna Manuals, however, a review is in order. It is our opinion that there are 4 basic parameters that loop performance should be based upon; 1). The loops signal to noise ratio. 2). The electrical Balance. 3). The selectivity or "Q" of the loop. 4). The mechanical rigidity/integrity of the coil assembly, and Alt-azimuth mechanism.

### Signal to Noise Ratio

Most efforts during the last 30 years have dealt with making loops smaller, to allow them to be used by the DXer who has limited space. S/N ratio has suffered as a result. The use of direct-coupled balanced FET amplifiers, and smaller, and smaller loop coils means that the bulk of the work in the system is being done by the amplifier. If you capture a very tiny signal, and add some amplifier noise to it, you have degraded what signal that you have to the point that you may bury a signal slightly above the noise floor. A rule of thumb would be to use no more amplification than is necessary. It is better to make the coil larger to enhance the capture area, and insure that what amplification is used is as low gain, and low noise as possible. The small loops are probably OK for most uses, but when you want to extract the last decibel out of the ether, a larger loop that is properly designed will be best.

### Electrical Balance

The electrical balance of the antenna insures that the current at the termination of one end of the loop tank coil is of equal magnitude and opposite polarity to that at the other termination of the loop coil. (A is equal and opposite B) When properly balanced the deepest possible null will be obtained, with the loop. Please note that balance is quite difficult to attain. Anything connected to the tank coil (or other metal brought physically near it) other than the resonating capacitor, can throw this balance (equal and opposite) off. This distorts the theoretical figure 8 pattern of the loop. If a link turn is used to couple the loop to the receiver, this link and the transmission line must be balanced, or coupled to an unbalanced line (Coax Cable) using a Balun. The link coil should be balanced, as well as the main tank coil. Using a balanced FET amplifier on the tank coil will throw off the balance if care is not to insure that the FET's are not exactly matched in their gain and transconductance. Not to mention that an amplifier not properly balanced, and running at excessive gain will be prone to create intermod products which degrade further the performance of the system. If a loop antenna seems to have a problem with hand capacitance it is a pretty good bet that it is not properly balanced. Refer to Nelson's article for detailed hints on how to attain balance.

### Selectivity

The "Q" or quality factor of the tank coil will determine its selectivity at resonance (the tuned frequency). If the "Q" of the tank coil is loaded (reduced by the effect of a load on the coil), the "Q" will decrease, and the selectivity of the loop will decrease, or broaden. In the late 60's Nelson devised the balanced FET amplifier as a way to minimize the loading of the tank coil. This allowed for selectivity that was so sharp that a loading potentiometer was added across the tank coil to reduce the "Q" so that the loop could be more easily tuned. Prior to this, loops were of the transformer variety, with the signal being coupled to the receiver via a link turn, wound amongst, but not attached to the windings of the main tank coil. This process did not take into full account transformer theory, as the loop is now a transformer due to the link coupling. The main drawback of the early designs is that they did not use the coefficient of coupling when designing the loops. Moving the winding away, somewhat from the main winding allows for less loading. Maximum energy transfer from the tank to the link would occur at "critical coupling". The load impedance also affects the loading, and should be matched to the impedance of the link turn, as well. As stated before the link should be balanced. A balun, and matching transformer should be used with a modern receiver with a 50 ohm coaxial input. The distance that the link turn is from the primary tank coil greatly affects the performance of the loop. The "Q" can be greatly improved, as well as the S/N ratio if the link turn is placed at the critical coupling point from the main primary tank winding. This distance from the main winding can be approximately determined prior to winding the link turn using a pocket radio. Tune the pocket radio into a station that is within the tuning range of the loop. Start out with the pocket radio placed facing the plane of the loop (see fig 2) right against the loop winding, rotate the loop capacitor for a peak (maximum signal) on the pocket radio. Now move the pocket radio 1/2" from the winding and re-peak the loop. Observe how sharply that the loop tunes. Move the pocket radio away from the loop in 1/2" increments. Observe how sharply the loop peaks on the pocket radio, as well as the signal strength at each point. The loop should peak more sharply, and increase its gain as the radio is moved away. The point of critical coupling is attained when the signal is at maximum, the sharpness may still increase somewhat, but the gain will fall off more rapidly as the radio is moved away. Note the critical coupling point, and wind the link coil this distance from the main winding. This process can also be used

when passively coupling the loop to a radio using a ferrite antenna, or when using a device such as a Select-A-Tenna, or a shotgun loop , or "Q" stick with a radio with a built in loop.

### **Mechanical Integrity**

Another consideration when building a loop is the mechanical design. This is often overlooked, and can affect the loop balance if the mechanics are sloppy. There are two different types of loop coil designs, The solenoid or box wound, and the spiral or pancake wound. Each type has several advantages, design trade offs, and disadvantages. The box loop has a higher gain for the same diameter, but is more difficult to balance. With this type of loop there is a trade off between the inter-electrode capacitance and the length to diameter ratio. Spreaders can be used to cut down on the inter-electrode capacitance, and to maintain coil rigidity. Note that the better the length to diameter ratio of the tank coil, the nulling ability is enhanced and balancing is easier. The spiral loop has the advantage of almost perfect length to diameter ratio, as well as being easier to balance. The main drawback of the spiral is its lower gain than the box loop. Also, if an amplifier is used, it is much more difficult to tap the tank coil at its center. An amplifier can be used more practically with the spiral by attaching it following the balun and matching transformer. This way the amplifier is isolated from the loop, and the undesirable unbalancing effects can be avoided. Note that an amplifier should be used only when necessary, and should be as low in gain as to improve signal strength on very weak signals, where not using it would yield them unreadable. It is important that the loop antenna be well constructed mechanically to insure that the wires do not flop around, to distort the balance, as well as to prohibit the need for re-winding. We have switched from wood to PVC in our designs, with a minimum of metallic objects near the tank, and link coils. Note that metallic objects within the near pick up field of the loop will induce a voltage into the coil unevenly and throw it out of balance.

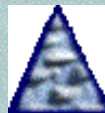

[Back to the top](#)

---

## **Links to further loop information.**

- 🌐 [Kiwa](#) Has the Pocket Loop, mods for your receiver and filter modules.
- 🌐 [Select-A-Tenna](#) Has some low cost loop antennas you can buy.
- 🌐 [Terk](#) Home of the Terk loop and other antennas.
- 🌐 [Wellbrook](#) Has a line of LW, MW, SW loops for the great outdoors.
- 🌐 [Palomar](#) Has a loop with different loop heads in different ranges.
- 🌐 [AOR LA-350](#) Active loop available at Grove.
- 🌐 [AOR](#) Their site for the LA-350
- 🌐 [Radio Plus+](#) Home of the Quantum Loop.
- 🌐 [Belar](#) LP-1 and LP-1A AM shielded loop antenna
- 🌐 [Torus Tuner Loop Antenna](#) is available in LW, MW, and SW.
- 🌐 [Twin Ferrite AM Antenna](#) Is available at [C. C. Crane](#)

- [Long Distance MW Listening](#) Great info on the Radio Nederland's site.
- [DIY MW Loop](#) On the Radio Nederland's site.
- [Ramsey](#) Signal Magnet Noise Reduction Kit
- [Mark Connellys](#) page of phasing units and amplifiers for radio
- [Loop Antennas](#) On the HCDX site
- [AM Box loop antennas](#) by Bruce Carter.
- [AMANDX](#) Is another construction site.
- [Hula Hoop Loop Antenna](#) has plans using a hula loop.
- [LF receiving loop](#) A large homemade loop.
- [AM Shielded Loop](#) From Radio Magazine.
- [Mag-Loop Antenna](#) Designed for SW it can also transmit.
- [Receiving Loop Aerial for 1.8 MHz](#) Is a shield loop out of coax.
- [Joe Carr's Tech Notes](#) Has articles on antennas.
- [VLF Loop](#) A loop for listening to solar activity.
- [PVC 4-7](#) Plans for a NDB loop.
- [Loop Theory](#) Is an excellent article on loop antenna theory.
- [AM Loop Calculator](#) Figure out what your loops should tune.
- [NRC](#) Has many book on loop antennas.
- [Vans Think Tank](#) Contains a good list of antenna links.
- [NRSC AM](#) bandwidth measurements with the loop antenna.
- [The Electronics Hobby Page](#) Another site with a excellent listing of antenna and DXing links.
- [AM Loop Antennas](#) Plans, links and theory.
- [AM Tuner](#) A tuner that you can build from tubes.
- [The Electronic Hobby Page](#) Has an extensive list of loop and radio information.
- [Small Transmitting Loop](#) for the HF band also has links to other loop sites.
- [Dave's Loop Antenna](#) He made this loop.
- [LF Loop](#) Plans for a 10 foot loop plus other LF information.
- [Loop Antenna](#) A circular antenna that VK2ZAY built.
- [Low Noise Coax Shielded Loop](#) for 160 to 10 Meters.
- [N5ESE's](#) Plans for a shielded loop receiving antenna.
- [Loop Amplifier](#) Build this amp to boost your loop.
- [Loop Group](#) Join this group on loops antenna on Yahoo.
- [The Toroid King](#) Has toroid to build your baluns they also have other parts.
- [Amidon](#) Another source for toroids.
- [AM Broadcast Band Antenna](#) Plans for a Active whip Antenna.
- [AM Radio Loop Antenna](#) A kit that you build from MTM Scientific.
- [Active VLF Loop Amp](#) Loop amp with negative resistance.
- [Balanced Loop Preamp](#) Give that loop a boost.



[Back to the MDXC Home Page](#)

[Club History](#) [Club Activities](#) [Club Meetings](#) [Radio Information](#) [ANARC](#)

[ [Home](#) ] [ [Up](#) ] [ [Minnesota DX Club](#) ] [ [Altered Photos](#) ] [ [Pavek Museum](#) ]  
[ [PVC Loops](#) ] [ [Links](#) ] [ [E-Mail](#) ]

[TV/FM DX](#) [Summer SW List](#) [Winter SW List](#)

This page was last updated on 08/03/04.

Any comments or suggestions can be made from my [E-mail Page](#)

---

### Bibliography

1). NRC DX News March 6, 1995, IRCA DX Monitor Dec 1994

" The Full size Full Performance Loop Antenna" Ray Moore

2). NRC Antenna reference Manual Vol 1 Dec 1995 Edition

"NRC Alt-azimuth Loop antenna P6

3). NRC Antenna Reference Manual Vol 1 1985 Edition

"HQ tests the Space Magnet" P40

4). ARRL Handbook 1988 Edition P39-3

5). QST Magazine July 1977 "Beat the Noise with a Scoop Loop"

Doug DeMaw

6). NRC Antenna Reference Manual Vol 1 Dec 1995, "The Hawk Loop"

7) NRC Antenna Reference Manual Vol 2 Dec 1995 "The Harley Loop" P 11

8). NRC Antenna Reference Manual Vol 1 Dec 1995 P21 " The NRC 2 Foot Loop"

### Suggested Reading:

1).National Radio Club Antenna Reference Manuals Vol 1 and 2 1995. Available from the National Radio Club P.O Box 164 Mannsville, NY 13661-0164

2). National Radio Club Loop Antennas Design and theory 1995

Available from the National Radio Club P. O. Box 164 Mannesville, NY 13661-0164

3). ARRL Antenna Book 1994 American Radio Relay League, 225 Main St., Newington, CT 06111-1494

4). Joe Carr's Receiving Antenna Handbook 1993, High Text Publications P.O. Box 1489 Solana Beach, CA 92075

# AM radio reception tips and links

[Home](#)

Here are several original suggestions I discovered for AM radio reception. After these tips are links to pages about improving [AM reception in your home](#) and on a separate page there are links for better [AM reception in your car](#). In both cases this is not just a list of links, I have provided commentary which brings together and organizes the web pages. I have recently added a page of [hints and links for better FM radio reception](#), and bringing in [EWTN on short-wave](#).

**Finally, and best of all, I have collected tips from many other web pages and added my own tips to form what is probably the most complete one web page collection of [AM radio reception tips](#) on the Internet.**

This page was written to help Catholics listen to low power Catholic AM stations, but physics is physics, so they will work for anyone. Because I am not a radio hobbyist and I am simply interested in communication the tips are simple, practical, and inexpensive.

[Home and office links](#)- [Car and truck links](#)- [My original tips](#)  
[FM tips and links](#)- [Complete AM radio reception Tips](#)

## Original tips for better AM radio reception

1. [Turn treble down, bass up for AM talk](#)
2. [Record the AM signal when it is strong](#)
3. [Most sources of interference are weak](#)
4. [Tip the radio to reduce interference](#)
5. [A loop antenna helps a lot when regular antenna is weak.](#)
6. [The best position for a loop antenna](#)
7. [A comparison of some good reasonably priced equipment](#)
8. [Old radios do not get all of today's AM band](#)
9. [A good shortwave radio is often a great AM radio](#)
10. [Are you really interested in that station? Try before you buy.](#)
11. [Mark the position of your station on the dial](#)
12. [Experiment, try different things](#)



1. If you are listening to talk radio turn the treble all the way down and the bass all the way up. Or if there is only one control marked tone turn it all the way to the low end. This will give you clear, easy to understand voices. This tip really helps a lot. I usually listen to music with the treble and base in the neutral middle position if the station is strong. I assume that is the way the musicians intended it.
2. Many weak AM stations, including many Catholic AM stations, cut their power at night, and you may get interference at one time during the day but not another. So you may be able to get a station during the day when you are at work, but not when you are free to listen to the program. You can use an automatic light timer, the type that is used to fool burglars into thinking you are home, to record radio programs when you are not at home. I have a popular web page giving the details of this idea and information and links for other methods of [timed radio recording](#).

The pilot of the Airwaves liked this idea so much that he put it on his [AM radio reception](#) web page. This is the only one of these tips you will find off of this site. The Pilot has a great page and has done me the honor of linking back to this page.

3. Many web sites list many sources of interference, florescent lights, televisions, computers, etc. I have been testing this and found that most of the commonly listed dangers are real, but the interference disappears if the radio is more than a foot, 30 centimeters, or so from the source of interference.

But sometimes a source of interference causes problems over a much wider area. For example, the people who lived down stairs from me at my former apartment had a TV that produced a loud buzz even though the TV was a good 20 feet away from the radio. But the much larger TV in our apartment which was five to ten feet away was no problem. So most of the time the normal sources of interference are a minor problem, but sometimes one of them is a big problem. You should treat the common lists of interference sources as a list of suspects, not a list of convicted criminals.

4. You can greatly reduce interference by pointing either end of the rod antenna in your radio directly at the source of interference. This is very important, but not at all original.

This is perhaps a more original tip, if the source of interference is higher or lower than the radio you may have to tip the radio to point either end of the antenna at the source of interference.

For example, if the interference is downstairs you may need to prop one end of the radio on a book and adjust it so that the radio angles down to aim the end of the antenna at the source of interference. I am not sure this is all that original, but maybe it is, and it helped with that TV downstairs I mentioned in the last suggestion.

5. I have bought a Radio Shack loop antenna which is now being discontinued and have had a chance to experiment with it. With a cheap radio the Radio Shack loop can make a big difference. I pick up the radio and move it away from the antenna and the station disappears all together, reappearing when I move the loop back. But with a good radio like the GE Superadio it is difficult to find any difference.

Many web sites will tell you that the antenna is more important than the radio, but good radios often have good antennas built in. The GE Superadio has a large ferrite antenna built into the back.

6. You get the best reception when the loop antenna is placed so that if it were a wheel it could be rolled toward the broadcast tower.

This is the opposite of how you use the regular AM antenna in the back of your radio. The antenna in the back of the radio should be placed so it is perpendicular to the signal. Think of it like a sail that is catching the radio waves. If the signal comes from the north then the ends of the radio should point East and West, and the back of the radio should face North or South.

A web page on loop antennas said the loop must be perpendicular to the internal antenna. I have tested this and found that what is relevant is the orientation of the loop antenna to the broadcast tower not the radio.

If the loop is not wired to the radio it will have to be close to the radio. If the loop antenna and the radio form a T, with the front or back of the radio facing the tower you will get an optimal signal, unless there is a source of interference.

7. I have had a chance to test and compare some equipment because other members of my parish had key pieces of equipment. The Select-A-Tenna did work better than the Radio Shack antenna. It also costs about a lot more, about \$60 for the Select-A-Tenna. The Radio Shack loop antenna may presently be available for \$10 or \$20 dollars, but the antenna has been discontinued and Radio Shack is selling out.

I was not able to tell much difference between the CCRadio from Crane and the GE Superadio III. But perhaps there is a difference between the CCRadio and the GE Superadio that I did not notice. The CCRadio is digitally tuned which should save you quite a bit of time over the years if you switch stations a lot. A note in my guest book says that the earlier versions of the GE Superadio were the best, and beat the early CCRadio.

If you listen to a lot of AM on hard to get stations it may well be worth it to pay an extra hundred dollars for even a small difference. The average person listens to over a thousand hours of radio a year. If you are an avid listener you could easily listen to more than 10,000 hours in the next decade, in which case the extra cost is a penny an hour.

On the other hand the CCRadio costs about the same amount as a great short wave radio and the great short wave radio might be almost as good as the CCRadio at bringing in AM. More on this below.

A note on the proper spelling of these products, useful for searching the web. The GE Superadio is spelled superadio, not superradio, or super radio. The CCRadio is not spelled CC Radio or C.C. Radio. The GE Superadio was originally produced by GE but has been produced by Thompson Electronics for many years. GE does not produce many or perhaps any of its home communications gear, but at least some of what it puts its brand on is exceptional. If you are looking to improve your TV reception, particularly UHF, I have found the Optima TV antenna really works wonders, but I digress.

Here is a web site that provides an extensive [comparison of the GE Superadio and the CCRadio](#).

8. In 1991 the FCC expanded the AM band to include 1605 to 1705. Earlier AM radios did not have those frequencies, so if you are searching for a station in that range you will need a newer radio. The only EWTN station with this problem is 1620 in Sacramento. The only other Catholic station I know of is 1670 in the Los Angeles area which does Spanish programming.
9. Good short-wave radios are frequently good AM radios. This is particularly important to Catholic radio fans because EWTN provides the exact same programming that is broadcast on Catholic stations by a short-wave signal that anyone can pick up.

Many weak AM stations, including many Catholic AM stations have a much stronger signal during the day, but must cut their power at night. The Catholic station which I used to get best, KSMH cuts their signal from 10,000 watts to 1,000 watts at sundown. After sundown you may lose the AM signal but it has commonly been believed that short-wave radio works best when the sun is not shining. To the degree that is true a short-wave that is better at night than the combination of AM and short-wave will provide you with EWTN 24/7, but actually I find that EWTN short-wave sometimes works quite well in the day time but you have to listen to it on a different frequencies. EWTN broadcasts on different frequencies at different times of the day.

If you do get a short-wave radio it may have to be a new one, because EWTN has in the past, and may still, be broadcasting on a new part of the short-wave band. As they change the frequencies the broadcast on from time to time the situation changes.

As a great short wave radio can be had for under 200 dollars you should think carefully before spending that kind of money or more on an AM radio.

People who are not fans of Catholic radio might find the short-wave option interesting if there is short-wave programming similar to the programming that they hope to get on AM.

The more expensive AM equipment is popular in places like Alaska where relatively isolated people have great difficulty picking up local news.

I have more information on [short-wave for EWTN here](#).

There is another option, [Sirius Satellite Radio, which is adding EWTN in English and Spanish](#) to its service. Once again one should look at this before spending hundreds on a very high end AM radio.

It also might be mentioned that [DirectTV](#) and [Dish Network](#) now carry EWTN in English. This is a television service not radio so I will leave it at that.

10. Before you spend a couple of hundred dollars to bring in a station you might want to find out if you really like it. As mentioned above, the average American spends close to a

thousand hours a year listening to radio according to the Statistical Abstract put out by the Bureau of the Census. The majority of that is FM, but a large minority is AM. If you are a radio fan, which you maybe if you have read this far, you might be spending more than a thousand hours a year. So if you listen to something hundreds of hours a year for several years even a couple of hundred dollars is dirt cheap. If you quickly lose interest it can be quite expensive. So how to check out the station without buying the equipment? Here are several ways.

You maybe able to listen to some short-wave stations and even distant AM and FM stations on the Internet to test your interest. If you have broadband you may simply want to listen to the station this way and skip the equipment, but if you have a dial up modem you will probably not want to tie up your phone line for hours at a time on a regular basis just to save a couple of hundred dollars on the radio equipment that could bring the station in. But even listening on the dial up modem is a good way to try the station before you buy the equipment.

Most libraries have public access to the Internet and you maybe able to listen to the station that interests you while surfing the Internet at the library.

If your normal travel by car brings you closer to a station that carries EWTN or any other channel that interest you this provides another opportunity to try before you buy. For example if you live in the San Francisco Bay Area and are thinking of getting short-wave to bring in EWTN you could listen to EWTN on 1620 AM in Sacramento when you are traveling through the valley near Sacramento. You can check the [Internet for stations near you](#).

If you travel around the country on vacation or business you are likely to be close to an EWTN station at least occasionally. Once again you can check the Internet before each trip to see if your itinerary will carry you within range of an EWTN station.

You might also be able to test your interest during the day on a weekend. As mentioned above the AM signal is often ten times as strong before sundown. If you work most of those hours that might not help during the week. But you might well get the station during the day on the weekend which will allow you to test your interest. For example many people in the San Francisco Bay area might be able to get 1620 AM the Sacramento station with a cheap radio during the day. A good shortwave radio or a GE Superadio might bring it in at night.

This idea of trying before you buy must be a preoccupation of mine. I sent a letter to the editor of the New York Times suggesting that online bookstores put an excerpt, the table of contents, and the index on their web sites so you could try the book before you buy. Some of the online bookstores were already putting few excerpts before the Times published my letter, but nobody to the best of my knowledge was putting the table of contents and the index online. A few months or perhaps a year later Amazon.com put up the "Look Inside" system for many of their books. The "Look Inside" system does everything my letter suggested, three different things I suggested were done, coincidence, maybe, maybe not. But back to AM radio.

11. When tuning in weak stations it is important to know exactly where the station is on the dial. You do not want to waste time carefully tuning in the wrong station. If you do not have digital tuning place a bit of invisible tape on the dial so that one side of the tape lines up with where one side of the needle should be when it is tuned into the desired station. If this is too messy for you, you can remember exactly where the needle lines up with any number AM or FM on the dial.

To find a station you might want to find a place where it comes in well, like outside or next to a window in a tall building, carefully mark where the station is on the dial, and then try again at home.

It also helps to remember strong stations that are near the station you want on the dial. Strong stations with distinctive programming are useful if you want to explain where a station is to a friend. You can also help friends find radio stations by putting the phone up to the radio so they can hear what it is playing while they try to tune it in. I find this helps them a lot. Helping your friends at church find Catholic stations is a great way to build up the faith and help Catholic radio.

This last suggestion, and perhaps some of the others may seem a bit trivial, one can see why a book or magazine article might not include them, but space is free on the Internet so I have attempted to include things that might normally be left out so you could try "every trick in the book."

12. Some one sent me an e-mail that said their reception improved when they were close to or touching their radio. Many people have noted this. I used to set my radio on a gallon jar of water

to get a similar effect. Things like this may make reception better or worse. What can I say, experiment.

You can help Catholic radio by spreading information on these and the other tips you will find at various web sites to your fellow parishioners. I demonstrated tips and equipment for the Legion of Mary and my prayer group. If the pastor does not object you might run demonstrations on Sunday morning in front of the church or put some key tips in the Church bulletin.

Here is a web page on Catholic radio stations nation wide, [Catholic Radio in U.S.](#)

In this web page I have been discussing AM radio, which is the American term, internationally the term middle wave is used. The tips are also useful for long wave radio.

## AM reception links for your home

Here are some links to web pages that contain suggestions that you will not find elsewhere. First some web pages for your home and then some for your [car](#).

I have written a summary of the tips from this page and many other pages. It maybe the most extensive collection of AM radio reception ideas on the web, though some of the other pages go into more depth on certain topics.

[A collection of tips based on many web sites](#)

The Pilot of the Airwaves has been a radio hobbyist for many years, and used to work for his college radio station. His page gives the standard advice, which is very important, but also has many other points based on his considerable experience. The pilot's page, like the one you are reading, is on Geocities.com.

[The Pilot of the Airwaves](#)

The Australian Broadcast Corporation, ABC, has put up several good pages on AM radio reception. These pages may not cover all the standard material, but they have material the others do not. One of the ABC pages is on troubleshooting at home. This page is currently set up so that you have to move the window from left to right to read it, only for the truly dedicated.

[The ABC tips on home trouble shooting](#)

Another ABC page is on home AM antennas. They do not like loop antennas, most other sites do. What they seem to recommend are big outdoor antennas that can be cheap but are difficult to set up and can cause a lightning strike. This page is easily read.

[The ABC tips on home AM antennas](#)

Here is another good place to check, because it has a couple of thoughts that other web pages do not, but it is rather short and does not have much of the material that other sites do have. One of his points was that if you have a two pronged plug in which both prongs are the same you might want to try turning the plug over so the prongs go into the opposite slots. He also suggests moving to another plug to eliminate interference that is coming through the plugs. eHow has lots of good practical ideas on many topics. You have to register to get all their advice.

[AM radio advice from ehow.com](#)

This web page addresses the issues from a different perspective and might be useful.

[Radio Communications Research Unit](#)

**Three web sites comparing the GE Superadio with the CCRadio**

Here is a careful comparison of the two strongly recommended AM radios.

[Comparison of the GE Superadio and the CCRadio](#)

Here is a sophisticated article on the CCRadio which also discusses the GE Superadio. The article tends to support the GE Superadio.

[Sophisticated article on the CCRadio and GE Superadio](#)

A popular page on talk radio in Philadelphia that has some material comparing the GE Superadio and Crane's CCRadio.

[Philly Talk Radio On Line](#)



## Two Web sites on Interference

This is a sophisticated page on AM interference problems. The writer explains what the different sources of interference sound like. This could help you narrow down the suspects as you search for the source of the noise. An advanced page for the person who wants to know all the tricks, but filled with material you will not find on any of the other pages.

[Sophisticated AM radio interference page](#)

Another intelligent page on interference. It suggests that many of our interference problems are the fault of the radio or television set.

[More wisdom on interference](#)

This web page has a very long list of AM links, many of them intended for AM hobbyists. The page even links to this one, so he must have good taste, right?

[Many AM reception and antenna links.](#)

Here is a web site put up by a radio station which may or may not have anything original. Either way it has a good summary of the basics.

AM tips from [KVFC](#)

Finally let me mention that you might find material on AM reception by searching for the interational term medium wave radio, more rarely called mediumwave and very rarely middle wave. Conversely if you are searching for information on medium wave you should use advice for AM radio which is the same thing. Long wave radio uses the same techniques as AM radio even though it is on a different part of the radio spectrum.

## Links, My Qualifications, and Contact Information

I have a masters degree in Economics and have passed the orals for a Ph.D. I taught economics full time at a large University for several years. I currently do a little freelance writing and have published in *Catholic Digest*, the *New Oxford Review*, and the *Sacramento Bee* among other places.

Have you got any thoughts on improving AM radio reception? Perhaps you know of an important web site that I missed. Why not write about them in my [guest book](#)? Geocities will e-mail me to inform me of your entry and only I will be able to read it, so this is like e-mail but I do not get as much spam. I may include your thoughts in this page, which had more than 2,900 hits in June 2004, and perhaps traditionally published works as well.

---

## On Site Radio Pages

- A collection of tips on [AM Radio reception](#) from many web sites
  - Links for [AM reception in cars, trucks, autos](#)
  - A new page of links and tips on [FM radio reception tips](#)
  - A new page on [short-wave, also called international band, radio for EWTN](#)
  - [Timed radio recording](#)
  - [Sacramento area Catholic radio](#)
  - [Answers to questions on AM radio reception](#)
- 

## Off Site Radio Links

This web site has been honored by a links from

- [Immaculate Heart Radio, Catholic radio for Sacramento, Stockton, Fresno, Bakersfield and Reno.](#)
- [Sacred Heart Radio, AM-1050, KBLE, Catholic Radio for the Seattle and Puget Sound area](#)

These seven stations, two near Fresno, are almost one third of all the AM stations that carry EWTN and have web sites. In the future I hope that other AM radio stations or networks will link to this site. Why not provide your listeners with the best information on how to bring your station in?

Let me note that Catholic Culture, previously Peter's Net, has given

this web site its highest rating for fidelity to the Catholic faith, so Catholic sites should be able to link to it without fear of being excluded by other Catholic web sites.

#### Lists of Catholic Radio Stations

- [EWTN's list of EWTN stations](#)
  - If you use this link you will get a list of EWTN stations, but at the bottom of the page is a link to a second page with a second list of Catholic stations that includes stations that are not EWTN stations. Strangely this second web page has an exact same url as the first one, but you can not get to the second page without going through the first. [St Joseph Radio provides a list of Catholic radio stations including some that are not EWTN](#) St. Joseph Radio's web site has an excellent orthodoxy rating from Catholic Culture. Perhaps there is some problem with the orthodoxy of non EWTN stations, but in my experience the liberal Catholics simply run music stations. They avoid hot button issues. Other conservative Catholic stations try to be more relevant to the layity but in my limited experience are still orthodox. I do not know that any of these stations is a problem, but if they are, put a note in my guest book.
- 

## Some Of My Other Web Pages

### Honored Pages

- Famous intellectual, Father Richard Neuhaus recommended my [web page on putting Catholic books into public libraries](#). in his magazine *First Things*. More recently recommended by the National Catholic Register.
- My article on [Vouchers](#) which was published in the *New Oxford Review*
- [My conversion story published in Catholic Digest](#), probably the most read English language Catholic periodical.
- A speculative essay on [foreshadowing and typology in the Old and New Testament](#) Comments of distinguished [professors and Bible experts on typology and foreshadowing](#), essay.

### Practical Pages

- [Programing a VCR](#)
- [Keeping a fish bowl](#)
- [Avoiding spam](#)
- [Good, Clean, Free, Internet Comics](#)
- [Avoid divorce by choosing well](#)



## An Inexcusable Page

[My lame attempts at apologetic humor](#)

This page is proudly [text only](#) because I value your time. I like to think that my site is information rich and graphics free.

Page last updated July 23, 2004

[Home page](#)



---

This page hosted by



Get your own [Free Home Page](#)



[\[ SITE INDEX \]](#)

---

# **LOW NOISE RECEIVE-ONLY COAX-LOOP ANTENNAS**

## **for 160 - 10 meters HF bands**



Station WN6F listening post

*Last Update: 29 March 2004*

After doing battle with locally-generated EMI / RFI for nearly two decades, I decided to do something about it. This antenna's main advantage is that it packs a lot of low-angle directivity into a small package. This makes nulling out many urban noise sources easy while enjoying good medium to high-angle skywave reception.

**NEW !!** (If you are interested in an easier-to-construct wire-only loop that has better performance, [check out my general-purpose wire-loop page](#)).

The directional small loop is also useful for significantly reducing static-crashes on the lower HF bands at times; this depends on mother nature of course. The larger loop is for 80 meters and the smaller loop is for 40 meters.

The project is described in four parts:

- [General construction and usage](#) (this page)
- [Operational analysis of this small loop](#)
- [Alternate loop winding methods](#)
- [Miscellaneous notes and experiments](#)

They are easy to build, and the only tools you'll need are wire cutters, some coax, and a tuner. You can make them for yourself or friends in a matter of minutes. Part of my design goal was to use a minimum of easily available parts. You won't need a well-stocked junkbox or any exceptional mechanical skills to build this antenna.

Winding the loops out of coax (providing a main antenna loop and an interior coupling loop) in the following fashion is very convenient and has six purposes:

1. The small wavelength outer-conductor loop (at 0.10 or smaller wavelength in circumference) provides the horizontal low-angle bidirectional directivity with deep nulls.
2. The gap in the braid at the top center of the loop allows common-mode reception of signals (both wanted and unwanted) on the outer skin of the loop braid to transition to the inner-skin of the braid. Rotational directivity nulls out the unwanted noise.
3. The current on the inner-skin of the braid now acts like a normal transmission line via the differential-mode to the center conductor.
4. This specially-wound loop acts as it's own balun, which is necessary when using unbalanced coax as the feedline. This helps to ensure that the feedline does not become part of the antenna. If it did, you'd lose much of your directionality, or have very strange nulls.
5. The large amount of distributed capacitance makes the loop somewhat

resistant to unbalance and detuning from hand-body-object capacitance than more traditional balanced wire loops.

6. The larger outer conductor diameter of the braid increases the sensitivity of the loop over that of a small-gauge wire.

**Prove it!:** Attach a clamp-on ferrite RF cable choke on the feedline and arms of the loop. When chokes are placed anywhere on the arms of the split-braid loop, severe detuning and attenuation takes place. When placed anywhere on the feedline after the loop output, no detuning or attenuation occurs.

HF loops built in this way are typically used for direct wave direction-finding. I'm more interested in using them as near-field noise-nullers to enhance the signal-to-noise ratio of skywave signals. This helps make up for their inherently lower gain than more traditional long wire antennas. A balun-effect is created by the way we wind the antenna back onto the feedline to help prevent common-mode noise ingress and maintain an accurate directional pattern.

**2004 update:** See below for [smaller TWO-TURN Loops!](#)

I'm using these antennas indoors right next to the operating position to make it easy to rotate and tune. Remote mounting is certainly possible, preferably with an antenna tuner or preamp located near the loop, although in that case I'd advise using a [plain wire loop](#) if you want to keep the tuner near the operating position.

---

**As an example, let's build a single-turn 0.10 wavelength loop for 40 meters:**  
(it will also function well as a .05 wavelength loop on 80m with retuning)

## WHAT YOU'LL NEED:

- For 40 meters, you'll need about 15 feet of coax (loop and some extra length for tuner connection, plus pigtail wrap.) I prefer to use 50-ohm RG-58. For convenience I picked up a 50-foot jumper at Radio Shack (#278-971A) which is already connectorized so I could build a few of them. You could also use 75-

ohm coax without any difficulty. Try to get the lowest capacitance cable that you can find.

- An antenna tuner can be used to tune the loop system to resonance. I've used L-type tuners and T-type tuners without any problems. I'm currently using an MFJ-16010 random-wire tuners which are small and use two SO-239 connectors which makes them easy to hook up and mount to a mast if desired. Note that on 160 meters, you'll need a lot of inductance, and the 16010 model doesn't seem to have enough when used with coax-loops.
- Optional: A 10 dB gain or more preamp can be used to help bring up the signal level. If your receiver has a preamp, and all it seems to do is bring up the noise level along with the signals, you are in for a treat. With this directional antenna, the preamp finally becomes useful in amplifying the signals, and not the noise.

Use the largest coax diameter you find practical. I use RG-58 since it is easier to work with, but the larger conductor size of RG-8 / 11 should perform a little bit better.

---

## LOOP SCHEMATICS:

My best artistic attempts at drawing the schematics.

Click on the images for a larger picture.

(Internet-Explorer users: IE has an option that automatically reduces the size of graphics. If the enlarged schematics look distorted, be sure to view them full-size, typically with F11 Key)

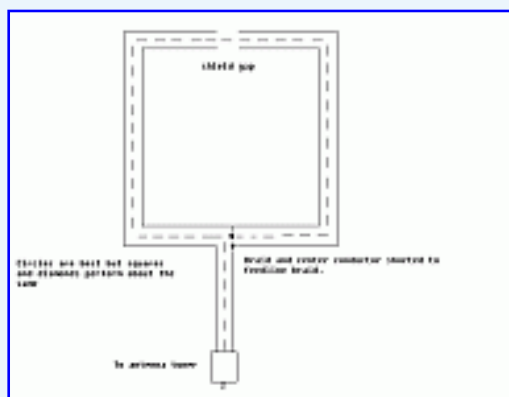



## HOW TO MAKE IT:

(Click on any of the images to enlarge them.)



1) First, at one end of the coax, let's short the braid and center conductor together with a pigtail. RG-8 was used to make it easier to see, although I like to use the smaller RG-58 or RG-6. After removing the outer covering, I bunched the braid back a bit to allow me to cut into the inner dielectric and then just pushed it back down when I was done. Take care not to cut or score the inner conductor with the knife, especially when using the smaller cables; when you wrap the pigtail around the braid in a later step, it has a tendency to snap at the cut or score when you wrap it.

(It might be easier to build the loop by following these instructions backwards if you already have a connectorized piece of cable.)

2) We need to create a 1-inch gap in the coax shield. Measure 7 feet from the shorted end, and make a small cut mark on the coax. A half inch on either side of the mark, cut through the outer covering exposing the braid. Then cut the braid out to expose just the inner dielectric. Try not to cut into the inner dielectric as this will mechanically weaken the antenna when you eventually mount it. The photos show some exposed braid at the gap just for clarity, but my antennas just have a clean cut. Note that this is just a true gap, you do not short anything at the gap! (Make sure there aren't any fine strands of shield wire still connected across the gap after you cut it!)



**KEY POINT:** The gap allows common-mode reception of radiated energy (both wanted and unwanted) on the outer braid skin to transition to differential-mode currents on the inner braid skin, which is coupled to the center conductor via differential-mode. Rotation nulls the unwanted common-mode energy exposed to the arms of the loop.



3) Measure another 7 feet from the center of the gap, and remove about 1 inch of the outer coax covering ONLY. You should just have some exposed braid.



4) Take the shorted pigtail end of the coax, and wrap it around the exposed braid from the previous step. This is the weakest point of the loop mechanically. Try not to make a radical bend at the point where the brittle center conductor is immediately shorted to the braid; it has a tendency to break if you do. Wrap at a point just a little bit further down the pigtail to avoid breaking the center

conductor.

**KEY POINT:** This finishes the self-forming balun and helps ensure that the unbalanced feedline does not become part of the balanced loop, thereby unbalancing it, and turning the loop into a noisy random wire.

(NOTE: don't be tempted to use an ordinary "tee" connector here. It won't work properly.)

You now have a highly directional low-band 40 meter loop and the rest is a small length of feedline that goes to the input of a tuner. Of course the jumper from the tuner output to the receiver can be any convenient length.



For 160 through 40 meter operation, you can mount the tuner anywhere from 6-inches to 6-feet away from the output of the loop. This allows you some flexibility if you want to keep the tuner on the desk and not on the mast. For smaller single-turn loops on 20 meters and above, try to keep the tuner no more than 6-inches away from the loop output - the closer to the loop output the better.



Note: Here is a very small loop for overall visual reference.

To construct a 20 meter loop, try a loop circumference of 7 feet. The gap is not critical for any band, and can stay at 1 inch. For 80 meters, try a loop circumference length of 27 feet or so. For 20 - 15 meters, try a 3-foot circumference; I'm amazed that this actually works as well as it does.

Note that when we cut loops for 0.10 wavelength, they will also perform well at half their frequency as a 0.05 wavelength, although sensitivity will be down somewhat. The positive tradeoff is that the nulls will be VERY deep at 0.05 wavelength.

## Design Your Own!

### UPDATE: MAJOR ERROR IN MY EARLIER DESIGNS!

**My apologies** go to earlier readers of these pages. I incorrectly assumed that since we are using coax as antenna elements, that they would be subject to a cable's velocity factor. Since the loop element is really the outer braid skin, **it is not subject to velocity factor**. Only the inner differential-mode of coax is subject to velocity factor, and NOT the common-mode outer surface conductor of the braid, which is what we are using as the antenna!

My standard formula for calculating the loop circumference for the frequency of interest at 1/10th wavelength *without any VF*, is:

$$(1005 / \text{freq mHz}) * 0.10$$

#### TUNING NOTES

This formula should get you in the ballpark, although if you can't get a definite peak with your tuner on the lowest frequency of interest, it is likely that the antenna is too long, or the distributed capacitance of the cable used is too high for your tuner to handle. Try using a more advanced tuner, or reduce the loop circumference length.

You can cut a new loop with a cable that has lower capacitance specs, or just make the existing one shorter. Fortunately it is easy to make a pre-cut loop shorter. Let's cut off two feet from the existing loop circumference as an example:

- Unwrap the shorted pigtail from around the exposed braid. Cut away a foot from this arm of the loop and create another shorted pigtail.
- Measure a foot from the center of the old exposed braid, and cut a new 1-inch exposure of braid.

- Wrap the new pigtail around the new exposed braid section and re-shape the antenna into the smaller shape. Tape up or heat-shrink the older exposed braid section.
- Try to be as accurate as possible and strive for balance when re-sizing the loop. Balance is important!

---

## USAGE:

You can create the loop with any shape you want, but circles are best, and squares and diamonds do nearly as well. Triangles, and extreme rectangles don't do as well, but don't let that stop you. The key is to enclose as much area as possible. For mounting, any sort of cross-brace should work, but I've also placed them on the back of non-metallic doors, hung them from ceilings, etc.

Tune the loop-system (loop and feedline) to resonance with the tuner. Since loops are high-q, you should hear a definite peak in the background noise. Better yet, tune to some locally-generated noise and peak on that. As you change each setting of the inductor, rotate the tuner capacitor(s) s-l-o-w-l-y.

The directivity pattern is a bidirectional figure-8 pattern at low angles, with maximum gain in the plane of the loop, and the nulls are broadside to it. It is just the **opposite** of an ordinary dipole. The loop seems progressively more omnidirectional to medium and high skywave angles.

If you want to see the directional azimuth and elevation angles, [check out my general-purpose wire-loop page](#). The patterns are almost exactly the same as compared to these coax-built loops.

You don't have to have the loop perfectly vertical, use whatever angle you need to null the local noise or storm-related static crashes - skywave signals will still be heard well. In one case, I have a noisemaker downstairs, so I had to rotate and tilt the loop at about 45 degrees to null it - it didn't attenuate the desired band signals at all. At times I've been able to track a storm all night and reduce the static crashes, and then sometimes not depending upon how localized the storm is.

You might notice that even though you've nulled out the noise, signal levels on a tuned loop seem to be about 2-to-3 S-units down from a standard 1/2-wave dipole mounted up at least a quarter-wave above ground. This is normal for a *tuned* small

loop given its short wavelength. You can compensate with a preamp, but you might find that with the noise level so low, you won't need one. If your normal antenna isn't mounted up at least a quarter-wavelength, the comparative loss might be even less!

Note: many modern radios that have built-in selectable preamps might have much lower sensitivity with the preamps off than other radios that don't have any preamps at all. This is a good design feature. Accordingly, with radios that have selectable preamps, it is likely you'll want to run with at least the first preamp turned ON.

The important point to remember is that your noise floor will be so much lower than your old noisy antenna that it more than makes up for brute signal strength.

## **Connector Quality Issues**

Make sure your connections are snug. If you lose the ground, you'll end up with a random-wire because you've lost the electrical balance. I mention this because as you insert or remove the connector from the tuner or receiver, when only the center-conductor is making a connection, you'll hear noise or signal level come up a bit. Unfortunately, you will have lost all the directivity that this antenna provides. Keep those connections tight.

A caution about crimped PL-259 connectors: sometimes the crimp is so tight that when you screw them fully into the chassis jacks, they don't actually make good contact with the chassis-connector center conductor. A **VERY GENTLE** squeeze with a pair of pliers on the center-conductor pin will help ensure good physical contact. I've run into this problem a lot with cheaper cables and sometimes it is not immediately apparent because you can still receive signals (poorly) due to capacitive coupling of the center pins.

Another drawback of cheaper connectors is that when you mate the dielectrics of the cable plug and chassis jack together, they sometimes don't allow the shells to make contact, especially if the "teeth" are short. You might only have a very poor shell-to-chassis connection via the rubbing of the cable's screw ring to the shell.

---

## **TWO-TURN LOOPS!**



To turn a large loop into something more manageable size-wise, try a continuous TWO-TURN loop. Each turn should have a 1-inch gap at the top of the turn, and at the bottom of the turn you attach the exposed braids and shorted pigtail together.

Turn spacing: you might want to put a coax-diameter's width of space between the two turns. I did this by winding one turn on the front of the mast and the other turn on the back.

(Click on any image to enlarge)



For example, my 40 meter single-turn diamond loop has a 14-foot circumference with an approximate 4-foot diameter.



I turned it into a two-turn loop

by starting with a new 14-foot length of coax, and depth-winding a second continuous turn around a 2-foot circular diameter instead of a square 4-foot diameter. At the top of the loop are my two turns with the 1-inch gaps at the center. At the bottom output of the loop I made sure the exposed braids and shorted pigtail are connected together. From this point, I left about 6 inches of coax terminated with a PL-259 connector which attaches to my portable MFJ-16010 tuner.

(Note: I recently placed the tuner on the desk with a 3 foot jumper instead since this loop was designed for the lower bands. For smaller single-turn loops designed for 20 meters or higher, the length of feed from the output of the loop to the tuner should not exceed 6 inches - the closer to the output the better.)

Try to make all your measurements, cuts, and braid connections as symmetrical as possible. Making the loop balanced is key to good noise rejection.

### **Here is how I made it:**

- I used a 15 foot length of coax to allow for a short 6-inch run to the tuner and

some left over to make the shorted pigtail.

- Six inches from the end of the connector, make a 1-inch cut around the coax to expose only the braid.
- Measure 3.5 feet from the center of the exposed braid, and cut a 1-inch gap (1/2 inch on both sides of the mark) through the braid to expose the dielectric.
- Measure 3.5 feet from the center of the exposed dielectric, and cut around the coax for 1 inch to expose only the braid. (1/2 inch on both sides of the mark.)
- Measure 3.5 feet from the center of the exposed braid, and cut a 1-inch gap (1/2 inch on both sides of the mark) through the braid to expose the dielectric.
- Measure 3.5 feet from the center of the exposed braid, and short the shield to the center conductor. Leave about 4 extra inches or so of this shorted pigtail.
- Wrap the coax into a two-turn loop with the exposed braids parallel to each other at the bottom, and the exposed dielectric gaps at the top. Use tie-wraps, tape, etc.
- Wrap the shorted pigtail around the centers of the exposed braid sections at the bottom so that all the braids are in contact. Solder or tape together.
- Put the loop on your support, attach your tuner to the connectorized end and enjoy!

The results of this two-turn loop are great! Signal output levels between my single and reduced-area double-turn loops seems about the same.

## **Casual MF BCB DX'ing and LF**

If you bypass the tuner, you might be able to use a loop cut for 80 or 160 meters in an untuned mode for casual MF BCB and LF reception. It is handy to null out the local broadcasters.

With the loop untuned, I've finally heard low-frequency CW beacons. So there IS life down there! For serious use, I'd definitely recommend specialized antennas for these bands, but at least an untuned loop might whet your appetite to go "lowdown".



## Other Sources of Info

I am indebted to all the Amateur Radio operators, SWL's, BCB DX'ers, VLF'ers and other experimenters that provide me with information and encouragement with this project. They participate in the **Yahoo!® Loop group** and also on the **rec.radio.amateur.antenna** newsgroup. All errors and misinterpretations belong to me however ...

If you're interested in loops, whether they be shielded, unshielded, magnetic, loopsticks, etc, you can find a great [discussion forum for loop antennas](#) on Yahoo!® by clicking here.

Be sure to [visit the K7ZB site](#) with his pics and nice build of this loop, along with other interesting antenna solutions.

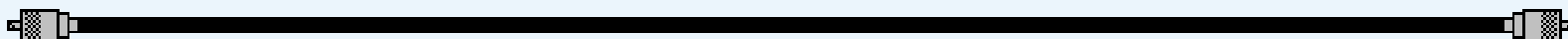

- [General construction and usage](#) (this page)
- [Operational analysis of this small loop](#)
- [Alternate loop winding methods](#)
- [Miscellaneous notes and experiments](#)
- [Easy-To-Build Small Wire Loops!](#)



24889

since 1 June 2003

© 2002-2004 [www.greertech.com](http://www.greertech.com)

# The VE7SL Radio Notebook

## A 10' RECEIVING LOOP FOR LOW-FREQUENCY DX WORK

( P. 2 - A BROADBAND SHIELDED LOOP FOR LF )



My ten foot air-core receiving loop was originally designed and constructed for NDB DXing. More recently, it has been pressed into service for LOWFER DX work. The loop has been instrumental in achieving two notable low-frequency receptions - the first Trans-Pacific reception of ZL (New Zealand) amateur radio signals in North America as well as establishing the present long-distance record for LOWFER reception in North America, the 1-watt signal of "NC" from North Carolina to British Columbia, an overland distance of 2,360 miles. The loop is a good performer!

OVERVIEW Basically the loop is like most antennas, just a big resonant tuned circuit probe that is coupling into the radio signal's electromagnetic field. Electrically, the loop

looks like the tuned circuit shown here. The 1-turn link couples signals out of the main loop to be fed to the receiver. The loop is tuned (signals peaked) with the variable tuning capacitor. The frequency tuning range of the loop basically depends on the number of turns in the main coil and the size of the tuning capacitor. My ten-foot loop has 14 turns of #20 plastic coated stranded copper wire. The tuning capacitor is a 400pf dual variable with both sections connected in parallel. The tuning range of the loop is from 180kHz to 410kHz approximately. By adding a 250pf silver mica fixed capacitor in parallel with the loop, tuning will drop to around 135kHz at the low end, perfect for the new 136kHz band when it arrives. Conversely, by shorting out the first turn in the loop, the lower end of the broadcast band can be tuned. Reducing the number of turns will raise the overall frequency tuning range. For the BCB DXer, I would suggest reducing the number of turns to 8 or 9. Going with even fewer turns, the loop would make a great low-noise, directional 160m receiving antenna.

**Loop Schematic**

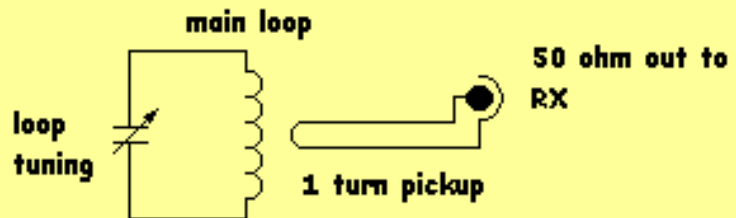

**FRAME LAYOUT**

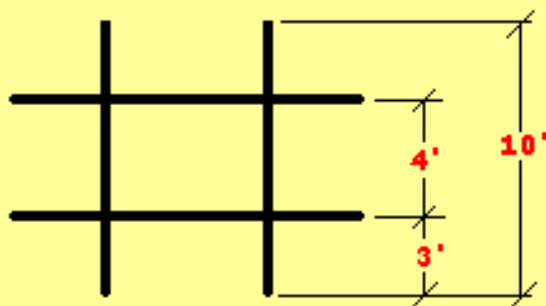

Four pcs 2" x 3/4" x 10'

**CONSTRUCTION-** The loop frame is built from 2 x 3/4 Western Red Cedar. Redwood, Yellow Cedar or even marine-grade plywood should serve equally well. Perhaps you have something similar, indigenous to your area that could be procured. The frame must be strong and weather resistant and of course the lighter you can make it, the better. The frame must not be metallic! The four legs of the frame are all 10 feet in length. At each crossover point, a half-lap joint has been cut

to join the frame together. Each joint has been screwed with a single brass wood screw and glued with two-part exterior water-proof glue. The loop has been outdoors for about 4 years now and has survived several dozen severe windstorms coming directly off the ocean. Part of it's "survivability" is due to the flexibility of it's 2" plastic ABS support mast. This allows the mast to absorb the brunt of the wind blasts. There have been several storms where the loop has been bent-over at a 30

degree angle for long periods yet it continues to survive, so far!

Attached to the end of each frame leg is a wooden "wire-comb" that is used to keep the loop wires in alignment. The spacing between each wire will determine the length of the comb. The wider the spacing, the better, but a point is quickly reached where the spacing makes the loop windings too "floppy". Each turn of my loop is spaced .25 inches apart. The wooden combs are 1.5" X 5" and have been glued and dowelled into a groove cut in the end of each frame leg. They could just as effectively be glued and screwed to the outside ends of all legs. In order to effectively capture each coil winding, the combs were drilled with the

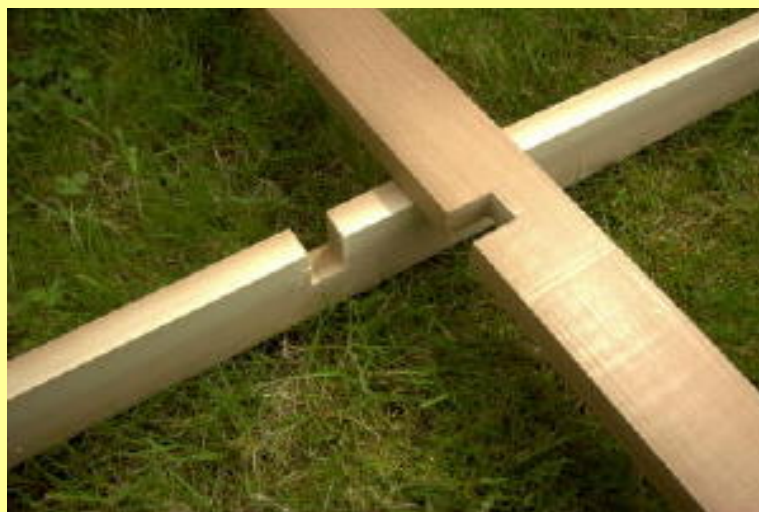

correct number of holes and then the top part of the comb was cut off, leaving the bottom half of each hole to act as a groove to capture and hold the wire.



Once the loop was wound, a heavy coating of the same two-part waterproof glue used earlier was liberally applied over the wires where they lay on the combs, anchoring them firmly in place.

The pickup loop (fed to the receiver via 50 ohm coaxial cable) is a 1-turn loop wound around the inside of the main loop. It is spaced approximately 6" inside the main winding. Wider spacing will result in reduced signal pickup as well as sharper tuning, necessitating frequent re-peaking. An advantage of the single turn pickup loop is that the loop is completely electrically isolated from the main station ground, often a source of induced noise pickup. In it's present configuration, it is only necessary to re-peak the tuning capacitor every 50KHz approximately. When DXing the NDB band (200-530KHz) it can often take an hour or more to carefully tune through the chosen 50KHz segment before re-tuning for the next range. If used for LOWFER DX work, it is simply a matter of 'set and forget' tuning!

**PERFORMANCE** As outlined earlier, the ten-foot loop has proven to be a good performer right from the start. Preamplifiers are often used with small homebrew loops to compensate for their low level of signal pick-up. The large aperture of this loop provides more than enough signal pick-up. No preamplification is used or required. Preamp-induced overload or cross-mod problems caused by nearby "blowtorch" signals are non-existent. The limiting factor of reception is always local or (more often than not) atmospheric noise, easily reached with the large aperture.

In an electrically noisy location, the loop can often be used to best advantage as a steerable "null" to eliminate or vastly reduce the noise source. In quiet locations, the loop can be

### LOOKING DOWN ONTO TOP OF LOOP

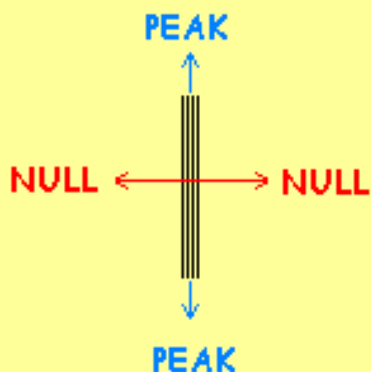

turned to enhance signal pick-up. Maximum signal pick-up is in the plane of the loop. For more information on loop antennas, see the links section below and ....good looping!

Steve (VE7SL)

## LOOP LINKS

[RECEIVING LOOP AERIALS FOR 1.8MHZ \(VK5BR\)](#) - *Plans for 160m RX loop and preamp*

[A.M. LOOP ANTENNAS](#) - *Construction info for several AM BCB loops*

[LOOP ANTENNAS](#) - *Almost everything you ever wanted to know about loops!*

[THE LOW FREQUENCY RECEIVING LOOP](#) - *A 6' air - core loop for the LOWFER band*

[SUPERLOOP RECEIVING ANTENNA FOR 136KHz](#) - *A nice air - core loop from G3LDO*

[THINKING ABOUT IDEAL LOOPS](#) - *A detailed discussion of loop dynamics*

[DOUG'S RADIO-ELECTRONICS LOOP ANTENNA PAGE](#) - *Various loop characteristics*

**THE OCTOLOOP** - *An LF loop by Lowfer N4YWK*

**160 / 80m COAXIAL RECEIVING LOOPS** - *Practical construction data*

**LISTENING FOR LOWFERS** - *Constructing an 8' air - core loop for LF*

**YAHOO! 'LOOPS' DISCUSSION GROUP** - *Talk with others about all kinds of loops!*

**HOME**



# Der Bau einer Rahmenantenne

Eigentlich, - ursprünglich, wollte ich ja diese Bauanleitung zu einem Bestandteil des vorherigen Artikels, des Super-Het-Empfängers, geschrieben haben. Die Gründe waren weil er a) sehr gute Empfangseigenschaften - speziell für den Superhet bot und b) in der Superhet-Schaltung, im Audion-Eingangskreis, diese Rahmenantenne schon eingeplant wurde (siehe die Super-Het-Schaltung, am Eingangskreis wird die Antennenspule L1 und L2 komplett durch den 2 x 2-poligen Schalter R abgeschaltet, die Rahmenantenne übernimmt die Funktion dieses Kreises).

Weil diese Rahmenantenne sich aber auch hervorragend für praktisch alle anderen Radio-Empfänger anbietet, entschloß ich mich, sie als separaten Bauvorschlag vorzustellen.

Eine Rahmenantenne wirkt in den den Sommermonaten störungsfreier als eine Außen- oder Hochantenne, der Empfang mit ihr ist bedeutend selektiver als mit einer Hochantenne.

- Je kleiner die Antenne, bzw. die Antennen-Kapazität, desto größer ist die Abstimmstärke.

Für diese Antenne wird ein quadratischer Holzrahmen mit 1 Meter Seitenlänge sowie 20 cm Rahmenbreite angefertigt - am besten geeignet ist Buchenholz. Dieser Rahmen wird mit 8 Windungen 1 mm dicker Antennenlitze bewickelt, im Windungs-Abstand von jeweils 0,5 cm. (Eine Zeichnung dieses Rahmens anzufertigen halte ich nicht für notwendig.. - ich denke, jeder kann sich vorstellen wie dieser Holzrahmen aussehen muß)

Je mehr Einzel-Litzen die Antennenlitze - HF-Litze, wie das "Rupalit" der Firma Pack Feindrähte - enthält, desto besser! - Ideal ist die Rupalit-HF-Litze mit 270 Einzeldrähten, 2-fach Seide umspinnen, mit einem größten Außendurchmesser von 1,1 mm, bei der der Einzeldraht - der natürlich

auch durch Lackierung noch einmal einzeln isoliert ist - einen Durchmesser von 0,04 mm besitzt. Eine 1 KG-Rolle hat hierbei eine Lauflänge von ca. 250 Meter.

- Ich bin in Kontakt mit einem Vereinsfreund, der sich bereit erklärte in absehbarer Zeit - ja nach Bestellung - Vorräte bestimmter Drahtstärken und -farben anzulegen und sie dann, je nach Bedarf (und Bestellung) in auch kleinen Mengen zu verkaufen.

Da ja für diese Antenne, bei einer Kantenlänge von 1 m sowie bei nur 8 Windungen eine Drahtlänge von 32 Metern ergibt, wäre diese Möglichkeit sicherlich - für den einen oder anderen alleine hierbei schon - hochinteressant - denn wohin sonst mit den restlichen ca. 220 Metern...

Eine Kombination aus Rahmen-Antenne **und** einer Antenne läßt sich erreichen wenn man in diesen Rahmen noch einen weiteren, inneren Rahmen gleicher Breite einsetzt, der mit etwa 2 - 5 Windungen - gleicher Draht, gleiche Wickelrichtung - bewickelt wird. Anfang und Ende dieser Wicklung wird mit der Hoch- oder Außenantenne bzw. der Erde verbunden.

Eine weitere Variante einer Rahmenantenne zeigt die Skizze eines frühen Empfängers mit Trichterlautsprecher und Rahmenantenne.

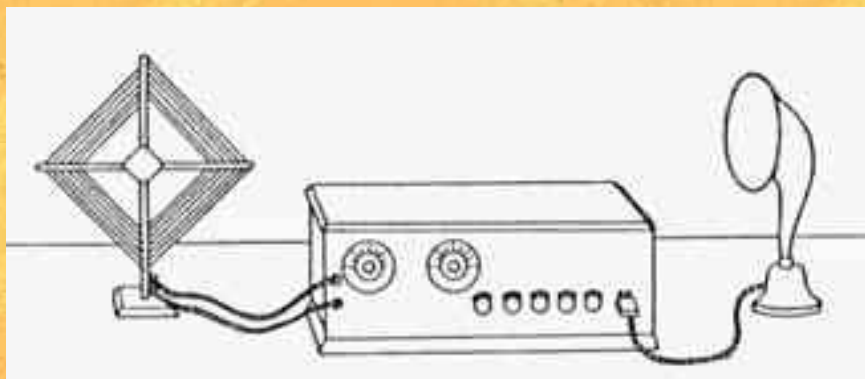

Eine solche Antenne wird mit zwei Holzstäben, 2 x 2 cm Querschnitt, hergestellt. Einer der beiden Stäbe ist 60 cm, der andere 65 cm lang. Die beiden Holzleisten aus Buche, beide in der Mitte - wie im Bild zu sehen - mit einer Nute in der Mitte.



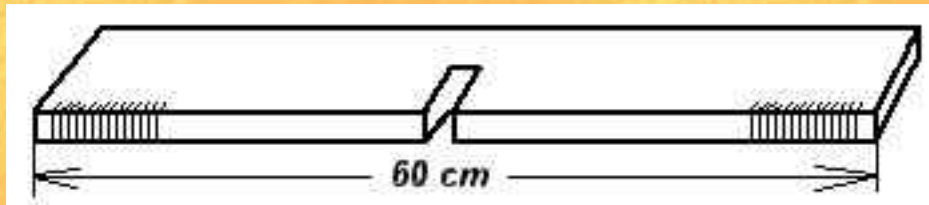

Damit werden die beiden Holzleisten zu einem Kreuz zusammengesteckt, die überstehenden Enden des einen Stabes dienen dazu, das Kreuz auf einem Bodenteil - wie bei einem Christbaumständer - zu befestigen. Es werden 15 Windungen 1-mm-HF-Litze (s.oben) spiralförmig von außen nach innen in das Kreuz hinein gewickelt. - Die Drahtbefestigungen können z.B. aus Messingnägeln bestehen, oder auch aus kleinen, mit einer feinen Säge hergestellten Einschnitten, wie sie im Bild angedeutet sind.

Der Abstand zwischen den einzelnen Nägeln (oder Einschnitten) - und damit zwischen den einzelnen Drähten - sollte jeweils 1 cm betragen. Diese so hergestellte Antenne ist optimiert für den Empfang des Wellenbereiches von 200 - 700 m, sie deckt also den gesamten Mittelwellenbereich ab.

Die beiden Ableitungen der Antenne werden dann in der üblichen Weise mit dem Empfänger verbunden - 1 Anschluß an den Antennen-Eingang, das zweite Ende wird mit der Erde verbunden.

Zum Abschluß zeige ich noch 2 Seiten aus einer Werbung aus der Zeit um 1928 - hier wird für Rahmenantennen geworben. - Man erkennt die vielfältigen Formen, wie eine solche Antenne aussehen kann und wie sie damals hergestellt und gekauft wurden...

## RINKEL-KLAPPRAHMEN-ANTENNEN

D. R. P. D. R. G. M.

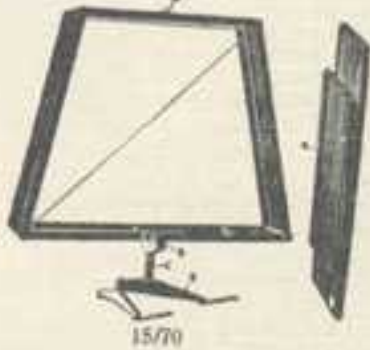

15/70

Mit einem Griff geöffnet oder geschlossen. Drähte bleiben in allen Stellungen, auch in geschlossenem Zustand gleichmäßig straff gespannt!

### 15/70 Type TR 62

Windungsfläche =  $0,25 \text{ m}^2$ ,  
Wellenbereich = 220 bis  
645 m, mit Verlängerungs-  
spule beliebig zu erhöhen.  
Größe zusammengeklappt:  
 $62 \times 47,5 \times 4 \text{ cm}$ .

b) mit exaktem Mittelabgriff.

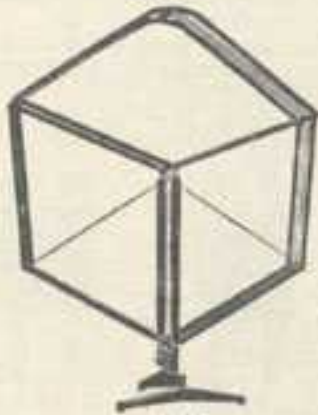

15/71

### 15/71 Type KR 63

Windungsfläche =  
 $\frac{1}{3} \text{ m}^2$ , Wellenbereich  
= 170 bis 950 m, mit  
Verlängerungsspule  
beliebig zu erhöhen.  
Größe zusammenge-  
klappt:  $63 \times 14,5 \times 7 \text{ cm}$ .

### 15/72 Type KRI 63

Mit einem Schaltergriff umschalt-  
bar für Rundfunk- und Langwellen.  
Höchster Wirkungsgrad, da stets  
sämtliche Windungen in Be-  
trieb und niemals tote Win-  
dungen vorhanden.

Windungsfläche =  $\frac{1}{3} \text{ m}^2$ , Wellen-  
bereich lückenlos 240 bis 1770 m.  
Größe zusammengeklappt:  $64,5 \times$   
 $22,5 \times 77 \text{ cm}$ .

b) mit exaktem Mittelabgriff.

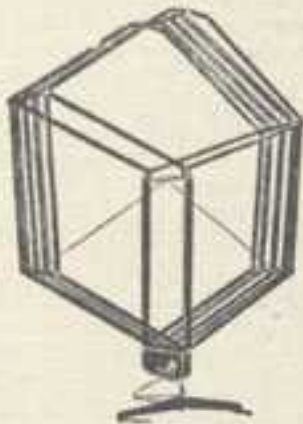

15/73

### 15/73 Rinkel - Rahmenschnur Type S 2

für alle Rahmen-Antennen, kapazitätsarm, hochfestibel, Länge 1 m.  
a) 2-adrig, b) 3-adrig.

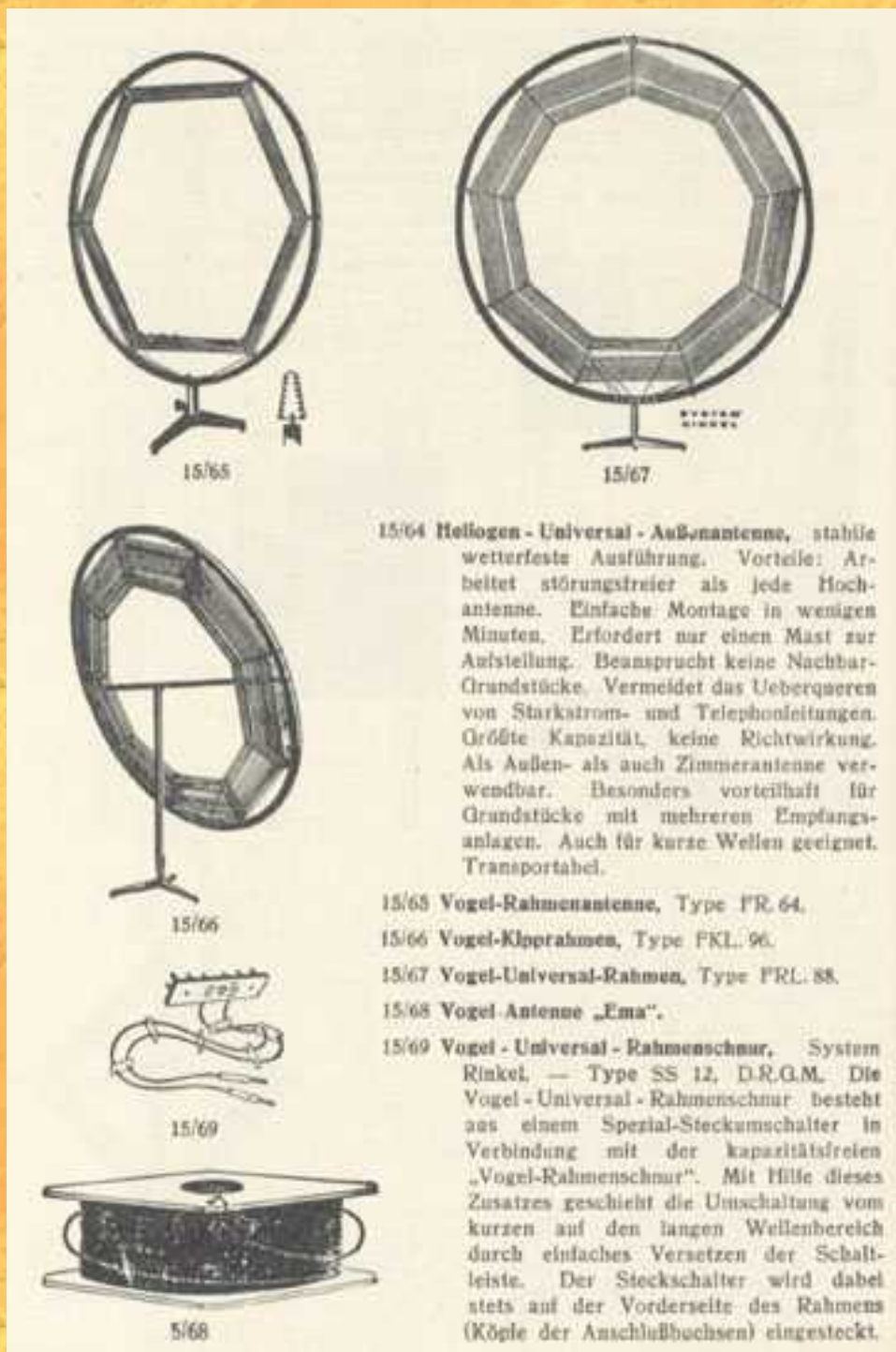

Ausgehend von einigen neuen Erkenntnissen möchte ich nun diese Seite erweitern. - Zunächst noch einmal etwas zur Funktion.

Die Rahmenantenne stellt eine Flachspule mit sehr großem Durchmesser dar, die unmittelbar aus dem elektromagnetischen Feld des Raumes Energie aufnimmt. Da die induzierte Spannung am größten ist, wenn die Spule senkrecht von den magnetischen Kraftlinien durchsetzt wird, so besitzt sie eine Richtwirkung.

Die für eine Rahmenantenne erforderliche Windungszahl  $n$  ist von der Seitenlänge  $s$  abhängig und beträgt für den Mittelwellenbereich :

bei  $s = 20 \text{ cm}$  . .  $n = 19$

$s = 25 \text{ cm}$  . .  $n = 14$

$s = 40 \text{ cm}$  . .  $n = 10$  Windungen

Für den Langwellenbereich ist etwa die vierfache Windungszahl erforderlich.

Hinweis: Da eine Rahmenantenne eine Spule darstellt, gilt hierbei keinesfalls: je länger der Draht - desto mehr Antennenenergie!

Um festzustellen ob die räumlichen Verhältnisse den Aufbau einer Rahmenantenne überhaupt sinnvoll macht (es sind die elektromagnetischen Sendeenergien, die man hiermit empfängt!), sollte man sich vorher mit einer Ferritantenne kundig machen.

Hierzu wird ein etwa 15 - 20 cm langer Ferritstab, ca. 10 mm Durchmesser, benötigt. Diesen bewickelt man, eng Windung an Windung, mit 50 Windungen HF-Litze. Ein Ende der Wicklung wird am Antenneneingang des Empfängers - beispielsweise ein Detektorgerät - angeschlossen, das andere Ende der Wicklung am Erdanschluß. Diese Antenne hat die gleichen Eigenschaften - auch in Hinsicht auf Qualität und Stärke der empfangenen Sender - wie eine Rahmenantenne.

Hat man jedoch keine Möglichkeit eine Rahmen- oder Ferritantenne verwenden zu können, beispielsweise wenn der Raum in dem der Empfänger mit zu viel Eisen(beton) abgeschirmt ist, so hilft eine Langdrahtantenne. - Bitte, weiterlesen!

Ich meine eine künstliche Langdrahtantenne...

Man besorgt sich einen Transistor und die paar externen Bauteile und lötet sie wie die hier vorgestellte Schaltung zusammen:

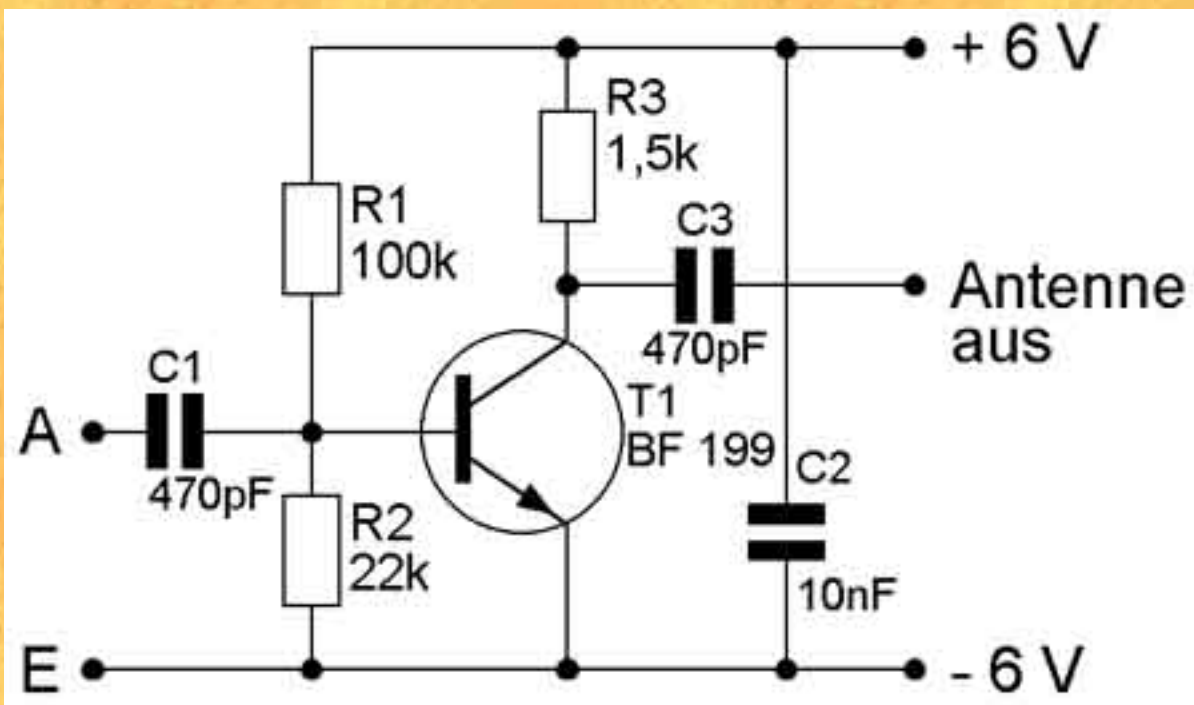

Quellennachweis dieser Schaltung: Funkgeschichte Nr. 55, S. 11. Schaltung nach Lörtsch, Detektorempfang mit einer 2 m langen Antenne.

Ein Freund von mir baute diese Schaltung auf einem 1 DM großen Lochrasterplattenstück auf. Die fertige Schaltung wurde dann mit einer Heißklebepistole auf dem Anschlußclip einer 9-Volt-Batterie befestigt. Ein 2 Meter langes Drahtstück - am Antenneneingang der Schaltung angelötet - wird somit zu einer 20 Meter langen Langdrahtantenne. Mein Freund, dessen Bastel- und Heizungskellerraum identisch sind, der von dickem Eisenbeton umgeben ist und mit einer Ferritantenne keinerlei Empfang hat, kann mit dieser künstlichen Langdrahtantenne sogar bestens seine Detektorgeräte "befeuern" . .

**Viel Spass beim Nachbau !**

[Zurück zur Hauptseite](#)

# A Universal LF/MF Preamp

By Lyle Koehler, KØLR

Perhaps calling this a "universal" preamp is stretching things a little, but it works on the LF and MF bands with loop, whip or random-length wire antennas. Regeneration can be used with any type of antenna, although the circuit provides very high gain even without it. Because of its versatility, this preamp is ideal for experimenting with various types of receiving antennas. This article also shows how the preamp can be powered and tuned remotely, with only a single coax line between the remote antenna site and the receiver.

## The Circuit

The universal preamp design is shown in Figure 1. It fits on a Radio Shack No. 276-150 general-purpose IC board with room to spare. Layout isn't especially critical; just follow the usual rules of RF circuit construction. Keep all leads as short as possible, and allow a respectable distance between the input and output leads. The preamp should be enclosed in a metal box to provide shielding. Tuning and regeneration control components are shown enclosed in dotted lines. Later in this article I'll show how these circuits can be modified to allow remote operation.

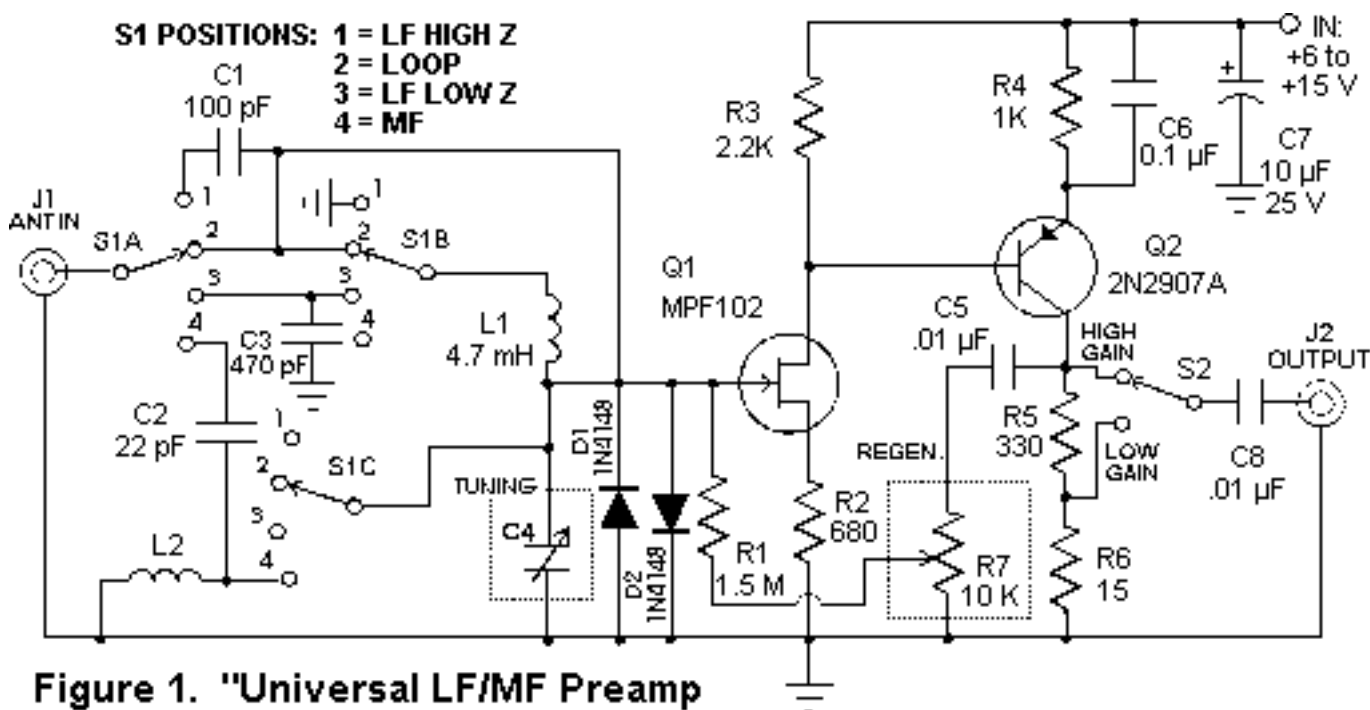

Additional parts information . . .

- L1: 4.7 millihenry (Mouser No. 434-17-472J or 434-06-472J)

- L2: 68 microhenry (32 turns #30 wire on FT-50-61 core or Mouser No. 43HH685)
- C4: 20-530 pF nominal (Mouser No. 24TR218; 2 sections connected in parallel) **See Addendum**
- S1: 3 pole 4 position switch (Mouser No. 10YX034)

*Notes:* The recommended part for C4 is a neat little capacitor but it comes without mounting screws or a knob. The best source for screws and a knob for this capacitor is an old AM transistor radio. Two options are shown for L1. Both have the same specified Q in the Mouser catalog, but the 434-17- series parts I've tested are somewhat better than the 434-06- parts. If you "roll your own" inductor L2 it will have a higher Q than the Mouser part. All of the other components are standard and their values are not critical. The Mouser Electronics toll-free number is 1-800-346-6873.

A four-position switch lets you select the input circuit that works best with your antenna. The "LOOP" position is for parallel-tuned loops fed with short lengths of coax. It will work at frequencies well beyond 10 MHz with a suitable loop (one that can resonate with C4). Using this circuit, I've heard IE on MF with a 7-inch long loopstick inside the shack, and have copied my own LF beacon in the daytime at over 250 miles with a 30-inch diameter, 22-turn loop. The "LF low Z" position works well with random-length wire or series-tuned loop antennas fed with long coax runs. Short whip antennas with short coax work best in the "LF high Z" position. An "MF" position is provided for use with MF antennas other than parallel-tuned loops.

Regeneration control is achieved by feeding part of the output signal back to the gate of Q1 through a variable attenuator and the gate resistor R1. This approach eliminates the need for feedback windings on L1 and L2, which would degrade the coil Q and complicate the switching. Another advantage of this circuit is that regeneration can be used with loop antennas without adding feedback windings. When regeneration is used, tuning becomes very sharp. A 20 or 30 pF fine tuning capacitor across C4 is recommended (if you can find one!).

This preamp has more gain than many receivers need. Switch S2 provides a way of attenuating the preamp output signal by about 20 dB, and a smaller value of R6 can be used if more attenuation is desired. S2 should be set to the "Low gain" position when regeneration is used. In fact, it may not be possible to reach the point of maximum usable regeneration (just before oscillation begins) with S2 in the "High gain" position.

### **Remote Control**

Suggested circuits for remote tuning and regeneration control are shown in Figure 2. Parts with three-digit numbers are additional components needed for remote control. Single-digit part numbers refer to components previously identified in Figure 1. Remote tuning is accomplished by using a back-to-back pair of varactor diodes in place of C4. The maximum capacity of a pair of MVAM109s in series is only about 250 pF. If desired, C4 can be left in the circuit to extend the low end of the tuning range, or another pair of varactor diodes can be connected in parallel with D101 and D102. MVAM109s are available from DC Electronics at (800) 467-7736.

## MODIFICATIONS TO PREAMP

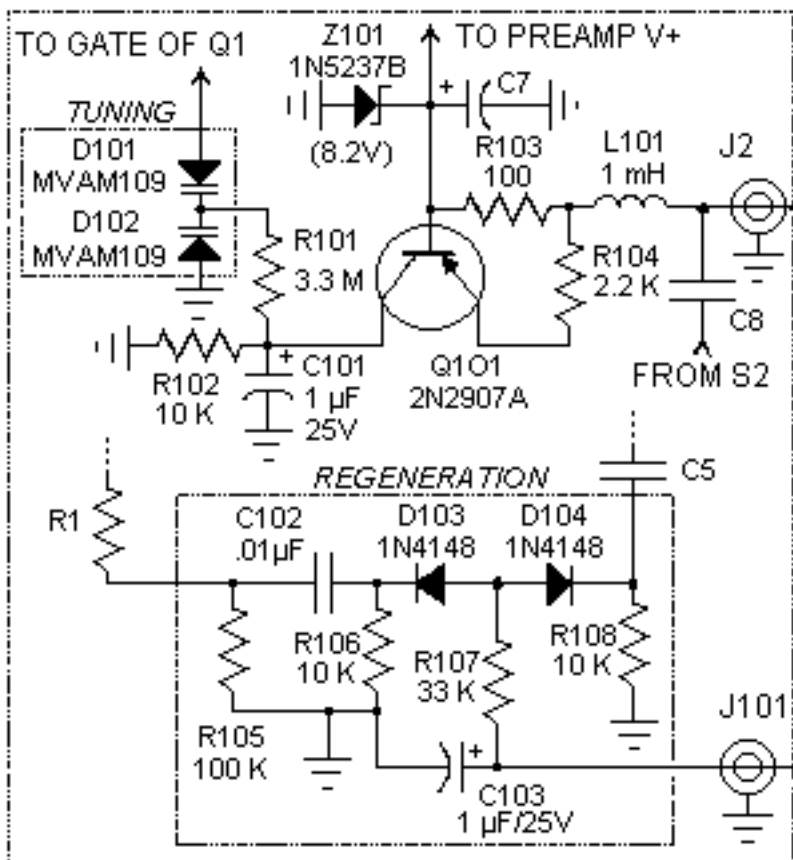

## REMOTE CONTROL UNIT

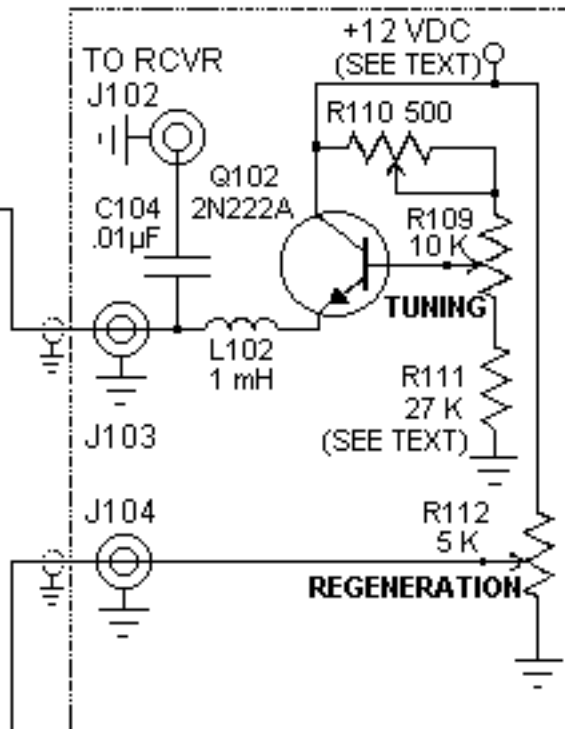

**Figure 2. Suggested circuits for remote tuning and regeneration control.**

If you want, you can run a multiple-conductor shielded cable between the control unit and preamp, and use separate wires for power, signal and tuning. (I've used 150 feet of ordinary audio cable in my field tests of the preamp with no significant loss of signal.) Separate wires let you use a much simpler remote tuning circuit. But that's too easy. Figure 2 shows how to make one shielded wire perform multiple tasks. Q101 functions as a DC amplifier with offset, so that the tuning voltage varies from zero to 9 volts while the voltage on J2 is varied from about 9 to 11.5 volts. RF chokes and blocking capacitors at each end of the line isolate the signal output from the DC supply/tuning voltage. With this circuit, a single coaxial line carries the power and tuning control voltage to the preamp, and brings the output signal back to the receiver.

The inductance values of L101 and L102 aren't critical, but they should each have a DC resistance less than 15 ohms. Some tweaking of the nominal 12 VDC supply voltage and/or the 27 K resistor (R111) may be needed to get the full tuning voltage range in your circuit. To check the circuit, connect a DC voltmeter between the collector of Q101 and ground. With the coarse tuning pot (R109) turned fully counter-clockwise, the voltmeter should read less than 0.5 volts. As you rotate the tuning pot, the voltmeter reading should begin to rise and should be close to 9 volts with the pot fully clockwise. Increasing the value of R111 will raise the minimum tuning voltage. Increasing the supply voltage will raise the tuning voltage at all settings of the tuning pot. The 500-ohm pot (R110) in Figure 2 is a "fine tuning" control. It can be omitted if you don't plan to use regeneration.



A diode attenuator circuit is used in place of R7 for remote regeneration control. Purists would use PIN diodes in the circuit, but 1N4148s work in this application. A separate wire is needed to carry the regeneration control signal. There's a practical limit for how much stuff we can do with one piece of coax. Actually, I haven't found that regeneration helps my LF reception -- certainly not enough to be worth the effort. In other environments, regeneration might offer some benefit, and it's hard to know unless you try it.

## **Performance**

When using a long wire or large dipole antenna, it may be necessary to attenuate the input signal to prevent overloading and intermodulation. If you experience overloading from AM broadcast stations, use the LF low Z position with an additional capacitor (.01 UF or larger) in parallel with the antenna terminals. If you're being hammered by Loran-C pulses, try switching to the LF high Z position and putting a small capacitor (10 or 20 pF) in series with the antenna.

Thanks to Bruce, AAØYB and Sam, WØIMG for leaving their beacons on during the thunderstorm season so I could perform some actual listening tests on LowFER signals. Both of their transmitters are about 95 miles from me, which provides a reliable signal path when the QRN isn't overwhelming. Using either the circuit of Figure 1 or a preamp with the remote tuning options in Figure 2, BK and SAM came in very well on a homebrew LF receiver with any of three portable loops ranging from 30 inches to 48 inches in diameter. Signals were also readable on a Radio Shack DX-440 portable receiver with all of the loops, although the 30-inch loop is pretty marginal.

A 40-inch whip antenna mounted about four feet off the ground seemed to be nearly useless for LowFER reception. Extending the whip length to 11 feet brought the signals up to a readable level, but not to the QSO quality attainable with the larger loops. Maybe the whip would perform better on sky-wave signals.

---

## **Addendum**

*In January, 1997, Lyle reports on a complication with the variable capacitor:*

Complaint department -- Mouser Electronics and Circuit Specialists have both discontinued the dual 266-pF variable capacitor used in the Universal Preamp. I don't know of any other supplier for this particular part. It's getting harder and harder to find an assured source of supply for variable capacitors.

---

*This article originally appeared in the August, 1995, issue of **The LOWDOWN**, and is protected under US and international copyright laws. Please obtain the author's permission before redistributing this document or reproducing it in any other form.*

---

 [Return to Longwave Antennas and Receivers Library.](#)

 [Go to Longwave Home Page.](#)

## *Rap 'n Tap*

[ [Home](#) | [Contents](#) | [Post](#) | [Reply](#) | [Next](#) | [Previous](#) | [Up](#) ]

---

# Re: Tuned Loop For AM Radio

**From:** Harvey Harbicht  
**Date:** 4/29/99  
**Time:** 12:17:46 AM  
**Remote Name:** 169.207.3.5

## Comments

Just a couple comments.

- 1) What's the real difference between a "Tuned Loop" and a xtal set? The diode and earphones.
- 2) For a beautiful loop, take a 6 foot piece (I think it's 6 foot) of 16-conductor computer ribbon cable and connect the ends together offset by one.

1 - 2 -1 3 -2 4 - 3 . . . 16-15 - 16

Add the cap or whatever you want.

Now you have a nice one-piece portable loop that you can carry in your coat pocket or hang around a nice frame.

Not my idea. I'm just passing it on.

As for the soldering.....I'm searching the stores for two snap-on connectors. One male and one female. I'm going to put them on the ends of my cable and just plug them together offset by one. I HATE soldering!!!

---

## *Rap 'n Tap*

[ [Home](#) | [Contents](#) | [Post](#) | [Reply](#) | [Next](#) | [Previous](#) | Up ]

---

# A convenient AM loop antenna

**From:** William Clarke

**Date:** 7/13/99

**Time:** 7:06:59 AM

**Remote Name:** 204.241.88.2

## Comments

I have found this antenna to work well across the AM BCB in spite of being close wound, which is said to lower "Q" and lead to increased stray capacitance.

The form is a 14" embroidery hoop (like in the Joe Carr book) with 14 turns of 26 ga. enamel wire close wound on it. I wound a 2 turn coupling loop over the main loop to attach to the receiver. The main loop has a variable cap (the 365 pF kind from the XSS) across it for tuning. I have a small imported vernier dial attached - a valuable tuning aid. The outer(split)hoop is attached to small wood plaque base (where the cap is mounted) with a 6" long dowell rod. (The hoop, base, and dowell can be purchased at a craft store like Michael's). The inner loop can be easily removed and replaced - like plug in coils for your antenna. (Get several hoops - they're cheap. A 10 turn space wound loop will work up to the 30 meter band.)

This antenna won't deliver the same power that a larger loop or long wire will, but it takes up a lot less space. It has good directional properties and is great for getting rid of noise. I can null out the attic fan with this thing.

---

# MTM Scientific, Inc... AM Radio Loop Antenna

*Purchase the Starter Kit, Deluxe Kit or Finished Antenna!*



Our **AM RADIO DX LOOP ANTENNA** converts your portable transistor radio into a long distance receiver, capable of pulling in distant AM radio stations. Works with any portable radio, without complicated connections. Simply put your radio near the antenna (as shown) and tune. Also improves local station reception. No batteries or power supply needed, great for camping and remote locations. Small enough to use on the kitchen table! Daily AM listeners appreciate improved reception of News, Sports and Talk. Especially fun at night, when the AM Powerhouse Stations are in play and reception distances soar. Great introduction to DXing... the hobby of listening for distant radio stations. Very simple to use, complete instructions included. This attractive unit uses solid copper wire around a beautiful oak frame with a brass dial plate and large tuning knob. Please Note! We pay for the shipping via Priority Mail in the USA. *This quality scientific product is ONLY available directly from MTM Scientific, Inc!*

Specifications: Tuning Range 550KHz-1700KHz, Size 18"x18"x8", Weight 2 lbs.

AM RADIO LOOP ANTENNA(Catalog # AMDX1000)... **SORRY: SOLD OUT**

## AM Loop Antenna Starter Kit

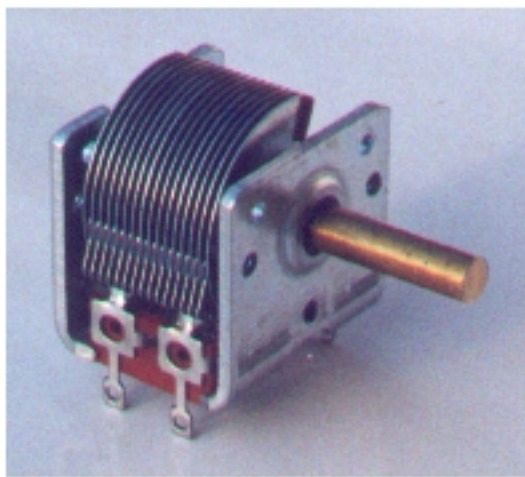
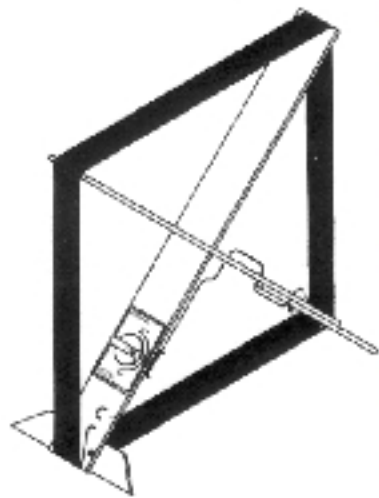

### **Detailed Plans & Variable Capacitor**

Our **Loop Antenna Starter Kit** contains detailed plans for building the MTM Scientific, Inc. loop antenna from scratch. The loop antenna is fairly easy to build using locally available parts... The only really difficult item is finding an air variable capacitor, so we are including one with every set of plans! This capacitor was custom manufactured for the antenna. The drawings in the plans are incredibly detailed and professionally done. Also included is a full size template sheet (24" x 36") for laying out and drilling the wooden frame pieces. Our plans eliminate the guess work in building an AM Radio loop antenna. *A GREAT wintertime project, only available from MTM Scientific, Inc!*

LOOP ANTENNA STARTER KIT (Catalog # LPKIT)...\$19.75 USA Shipping Included

**BY PAYPAL:** To order using Paypal, click the button. (Paypal is a great way to send money using email and a credit card... check it out!) **BY MAIL:** See information below.

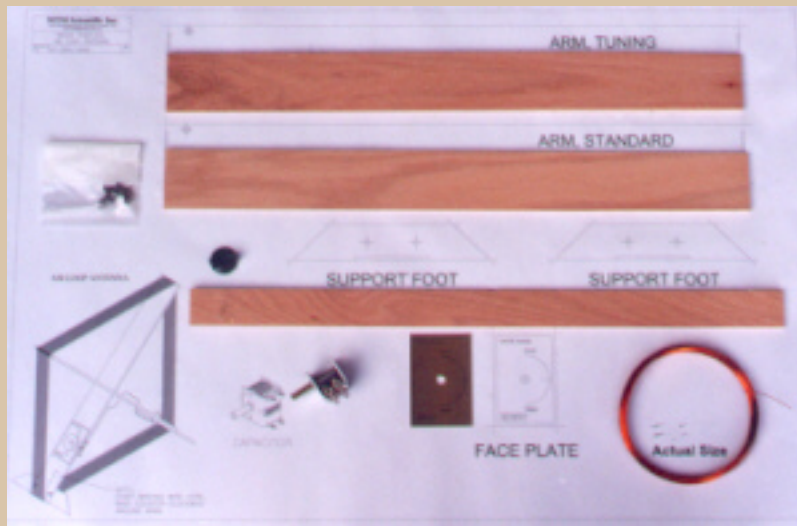

Our **Deluxe Loop Antenna Kit** contains ALL the hardware for building the MTM Scientific AM Radio Loop Antenna... Including the magnet wire, wood, air variable capacitor, brass dial plate, stainless steel hardware and tuning knob. Of course, the detailed plans and full size template sheet are also included. Please note that construction requires sawing and drilling to form the loop's frame. This kit allows you to concentrate on building the antenna, instead of scrounging around for the parts! Represents a nice savings compared to the price of an assembled antenna, and with care, the final product will look every bit as great. Please Note that the price *includes shipping* in the USA.

DELUXE LOOP ANTENNA KIT (Catalog # DXKIT)...\$48.75 USA Shipping Included

**BY PAYPAL:** To order using Paypal, click the button. (Paypal is a great way to send money using email and a credit card... check it out!) **BY MAIL:** See information below.

---

## ADDITIONAL ORDERING INFORMATION

*We keep ordering simple! Prompt, courteous 30 day refund policy.*

**BY MAIL**....please send a Check or Money Order (Starter Kit \$19.75, Deluxe Kit \$48.75) to:

MTM Scientific, Inc. P.O. Box 522, Clinton, Michigan 49236

No delays for Personal Checks. We always ship promptly via Priority Mail.

---

**BY PAYPAL**... click the buttons above, or Paypal directly to [mtm@mtmscientific.com](mailto:mtm@mtmscientific.com)

---

\*Note: International Orders are *always welcome*, but we must charge for the additional cost of shipping.  
[Click here to inquire by EMAIL](#)

---

[Click Here to view other MTM Scientific, Inc. Products](#)





# Palomar® Engineers

## Loop Antenna

- Home
- RFI Kit
- Ferrite Cores
- Ferrite Beads
- Iron Powder
- Tuner-Tuner
- VLF Converter
- Loop Antenna
- L. Wire Balun
- Balun Kits
- Palomar
- Toroid Cross Reference
- Order Form

Phone:  
**760-747-3343**  
 FAX:  
**760-747-3346**  
 Mail:  
 PO Box 462222  
 Escondido CA  
 92046  
 eMail: Info@  
 Palomar-Engi  
 neers.com



### Amplifier with plug-in loop

Palomar's Loop Antenna gives superb performance on the AM medium-wave broadcast band. The loop rotates and tilts to give deep nulls so you can eliminate local interference. It also allows you to null out a station and listen to another one on the same frequency. Only loops that tilt can do this.

The loops plug into the LA-1 loop amplifier. It has the tuning control and a power switch on its front panel. The rear panel has a UHF connector for the radio connection and a clip to hold the 9-volt battery.

The AM broadcast antenna covers 530-1700 KHz which includes the new expanded band. The HF plug in loop covers 1700-6000 KHz for the amateur 160 and 80 meter bands as well as the nighttime shortwave bands. The LF plug in loop covers 150-550 KHz. The VLF plug in loop covers 50-150 KHz. Note: The loops do not work without the amplifier.

LA-1 Loop Amplifier .....\$135.00 530-1700  
 KHz Loop (Medium Wave Broadcast).....\$135.00 1700-6000 KHz  
 Loop (160/80 amateur & shortwave broadcast...\$135.00 150-550 KHz Loop  
 (Low Frequency Band).....\$135.00 50-150 KHz Loop (VLF  
 Band).....\$150.00 Add \$6 shipping/handling per  
 order. Tax in California.

Some radios have built-in antennas for the AM broadcast band and no connection for an external AM antenna. To connect to these radios use our loop coupler. It takes the loop amplifier output and converts it to a magnetic field that couples to the radio's antenna. AM reception is much improved. Weak signals become strong.

LC-1 Loop  
 Coupler.....\$49.95

[Our new catalog and RFI Tip Sheet will be mailed to you free on request..](#)



# PROTECTIONTECH

[Home](#)[Up](#)

## All About Inductive Loops

The material below describes the technology and reported performance of Loop Detectors. The document is divided into the following sections:

- [Principles and Theory of Operation](#)
- [Detector Configuration](#)
- [Selection Criteria](#)
- [Installation and Maintenance Considerations](#)
- [Attainable Information](#)
- [Data Reliability](#)

---

### Principles and Theory of Operation

Loop detectors operate on the principle of inductance, the property of a wire or circuit element to "induce" currents in isolated but adjacent conductive media. A detector consists of an insulated electrical wire, placed on or below the road surface, attached to a signal amplifier, a power source, and other electronics. Driving an alternating current (normal operating frequency between 10kHz and 200kHz) through the wire generates an electromagnetic field around the loop. Any conductor, such as the engine of a car, which passes through the field will absorb electromagnetic energy and simultaneously decrease the inductance and frequency of the loop. For most conventional installations, when the inductance or frequency changes a preset threshold in the actuate detector electronics, this indicates that a vehicle has been detected. Many factors determine loop inductance, including wire size, wire length, the number of turns, lead length, and insulation.

### Detector Configuration

As noted above, the elements of a detector include:

- an inductive loop
- a pull box
- a lead-in cable
- a loop controller, which normally consists of a tuning network, a signal amplifier, a data accumulator and other detector electronics

The inductive loop is an insulated electrical wire, usually several meters to a side, with several turns. Loops are installed in a variety of shapes such as square, rectangle, diamond, circular and octagonal, though each configuration produces a different electromagnetic field. For instance, diamond loops reduce the probability of detecting vehicles in adjacent lanes. The pull-box, usually located adjacent to the road, houses the splices between the lead-in cable from the controller and the lead-in wires from the loop. Lead-in wires are usually shielded and twisted to eliminate disturbances from external electromagnetic fields, such as adjacent loops. The controller electronics, usually housed in a rugged cabinet in a safer more accessible location, detect, amplify, and process loop signals. The controller orchestrates loop operation and provides power. A typical controller can handle up to forty loops, though in practice will probably oversee far fewer.

Inductive loops may be placed either on the road surface, or up to twenty inches or more into the pavement. While deep buried loops exhibit a longer life span, their electromagnetic field is weaker and detection becomes more difficult. Loop sensitivity, defined as the smallest change in inductance which will cause actuation, decreases around 5% for every inch into the pavement the loop is installed. Since the characteristic shape of a detection is not distorted, additional loop turns which emit a stronger loop field can compensate for pavement interference. Unless loops are installed during road construction, installation requires a saw cut, up to 10 mm wide, into the pavement. Unfortunately saw cuts have been found to undermine the structural stability of the pavement in some cases.

Wire type also influences loop operation. Most inductive loops are formed by wrapping a single wire strand around the loop shape a prescribed number of times. Because these turns are spaced randomly, the electromagnetic field, and consequently detection results may vary from detector to detector. It has been established that a multi-conductor cable, which holds the loops in uniform proximity, will produce more accurate measurements. Installation of the multi-conductor necessitates a wider cut into the pavement than the single wire configuration. Ruggedized, weather resistant pre-formed loops are available which aid in uniformity, but also can be more difficult to install.

Detectors operate in either the pulse or presence mode. Presence operation, often used with traffic signals, implies that detector output will remain "on" while a vehicle is over the loop. Pulsed detection requires the detector to generate a short pulse (e.g. 100 to 150 ms) every time a vehicle enters the loop, regardless of the actual departure of the detected vehicle.

Many detectors today employ digital technologies which sense a change in the resonant frequency of a loop due to a decrease in inductance. Digital techniques allow more reliable and precise measurements than their analog counterparts. Some digital units incorporate advanced electronics such as self-tuning amplifiers, open-loop test functions, and automatic or remote reset capabilities. These features can significantly reduce detector maintenance costs and calls. The newest detectors can actually output the digitally sampled inductance "signature" of each vehicle, allowing the development of flexible signal processing software to add considerable more robustness than the hardwired set "threshold" detectors.

## Selection Criteria

Several parameters characterize the performance of loop detectors:

### Response Time

Defined as the time between the when inductance crosses the preset "threshold" due to the arrival or departure of a vehicle, and when this is indicated on the digital output side of the detector. A consistent and fast response time is crucial for accurate speed measurements. Response time is affected by vehicle size, speed, detector type, sensitivity, and wire type. Response time decreases with smaller vehicles, which have lower ground clearance and a shorter distance to the engine block and axle. Faster speeds tend to reduce response time, as does increased sensitivity.

### Recovery Time

The time required for a loop to return to normal operation after a period of sustained occupancy. Recovery time is particularly important for vehicle counting. Loop standards dictate that after a sustained occupancy of five minutes a detector return to at least 90% of the minimum sensitivity within one second after the zone of detection is vacated.

## Installation and Maintenance Considerations

For comprehensive surveillance of mainline routes, detector stations (possibly pairs) should be installed every 600 to 1200 meters. Loops should also be stationed around access and egress points, and at any locations where operational problems occur. Provisions should also be made for maintenance access. Different degrees of processing of raw loop data may be performed at the TMC or remotely in the field. Remote analysis requires additional processing hardware for each detector station, but less sophisticated communication links, since only the data relevant to highway surveillance is transmitted back to the TMC. In contrast, centralized analysis requires the transmission of large quantities of raw data and greater hardware requirements (storage and processing) at the TMC. If transmission lines are leased, which is often the case, data transmission costs can become cost prohibitive.

Annual maintenance costs average around 10% of the original installation and capital cost, adjusted for inflation.

Loop failure rates are strongly related to maintenance and installation procedures. Surveys of state DOTs indicate that failure rates vary significantly, ranging anywhere from three to fifteen percent per year. In practice, loop inspection procedures also vary substantially among DOTs. Loops may be inspected anywhere from one to twenty-five times per year. Highest inspection rates occur where loop operation is critical to the operation of other deployed traffic management systems. In many instances loop maintenance costs are sufficiently high that malfunctioning loops are replaced outright, without any diagnosis of the cause of failure. Because loops have been deployed extensively, consistent installation recommendations and primary causes of loop failure have been documented.

## Installation

Installation recommendations for effective and long lasting loop systems include:

- installation and calibration should as uniform as possible.
- saw cuts should be cleaned out and dried before loop installation. Saw cuts should also be of uniform depth.
- Loops should be properly sealed.
- detectors should feed off the same power supply.

## Mechanical Failure

Many factors contribute to physical loop failure. Pavement and sealant (of the saw cut) failure are commonly identified as the primary culprits. Pavement failure or deformation (cracking, rutting, potholes, or shoving) causes loop wires to be strained resulting in breakage, wire insulation wear, or the infiltration of foreign materials. Sharp bends in loop corners have also been found to cause problems, such that the insulation deteriorated or was broken.

Sealant failure poses additional problems. Once the sealant fails, the loop may become exposed or foreign materials may infiltrate the cut. In many cases the loop was found to have floated to the top of the cut, either before the sealant could cure or because it remained plastic. Other common sources of loop failure include poor installation and maintenance procedures, damage from utility repair or construction, lightning surges, detuned amplifiers, and corroded splices or wires.

## Data Malfunction

Many sources of loop malfunction can produce erroneous detector data. These include stuck sensors, hanging (on or off), chattering, cross-talk, pulse breakup, and intermittent malfunction. Cross-talk involves the mutual coupling of magnetic fields that produces interaction between two or more detector units which are in the same cabinet or in close proximity to each other. Cross-talk results in erratic loop behavior and inaccurate detections. Pulse break-up involves gaps in detector actuation data, which may be incorrectly interpreted as different vehicles. As described below, many of the these problems can be corrected with data filters.

## Attainable Information

Loop detectors supply several pieces of information about prevailing traffic conditions, including vehicle presence, flow, occupancy, and velocity. A good loop detector system is cited as accurate to within 5%. The accuracy and consistency of detector output is a strong function of installation and calibration procedures. For example, it is possible that detectors with different sensitivities longitudinally separated by thirty feet give occupancy data which differs by 40%. Loop detectors are also limited by their inability to detect stationary vehicles.

Flow and occupancy may be extracted directly from loop data. Speed may be approximated from the data of a single detector using the fundamental theory of traffic flow:

$$\text{flow} = \text{speed} * \text{density}$$

where density is approximated from occupancy by:

$$\text{density} = \text{occupancy} * g$$

and

$$g = \frac{K}{(\text{vehicle length} + \text{detector length})}$$

where K is a conversion factor. While it is possible to obtain reasonable speed estimates with this strategy, paired loops offer a more accurate approach. Velocity is calculated from the travel time between two loop detectors which are separated by a known distance. Accurately calibrated speed traps with loops of individual wire can expect to achieve measurement errors of 5-8 kph (3-5 mph) at low speeds and 16-19 kph (10-12 mph) at high speeds. Multi-conductor cable loops average errors about 0.3 kph (0.2 mph) at low speeds and 5-8 kph (3-5 mph) at high speeds.

There are several considerations in speed trap design. For one, loop inductance is a strong function of vehicle speed. One study determined that a vehicle travelling at 20 mph produced a 3% inductance shift, while another at 80 mph yielded only a 1% inductance shift. Sensitivity settings may have to be adjusted when ILDs are used in high-speed freeway environments. The separation between loops is another relevant variable. In practice anywhere from 2 meters to more than 20 meters is feasible. However if detectors are too close cross-talk may occur, while detectors spaced too far apart may be susceptible to vehicle lane changes. Suggested optimal spacing is around 9m.

## Data Reliability

For traffic management strategies such as incident detection to be effective loop data must be reliable and accurate. Many TMCs use a combination of manual inspection and reliability tests to validate incoming data. Such tests serve a dual purpose, they flag erroneous data and identify malfunctioning loops. Various approaches are employed to identify inaccurate data.

Initial error detection often occurs in the field. The data may be filtered, where pulses or gaps in actuation less than some brief interval, say one-fifteenth of a second, are ignored. The data may be flagged as unreliable if a microprocessor sees more than two valid pulses

(vehicle endings) in a second. These tests usually detect gross errors, but other malfunctions may go unnoticed.

More advanced filtering techniques are available to validate loop data. One approach is to compare a detector's on time to the average on-time of all other detectors at that station. A second strategy compares detector data (volume, occupancy, and speed) against realistic thresholds at periodic time intervals. For example, detector data is flagged if occupancy exceeds a predefined maximum for a certain period of time (say more than 90% for five minutes). A more complex algorithm uses a multi-regime comparison of the flow - occupancy ratio to maximum and minimum expected speeds. Occupancy is converted to density using a variable  $g$  which varies as function of occupancy. Research has shown that a constant  $g$  can introduce significant error into speed estimates. These algorithms achieve good detection rates with low false alarms rates, and often identify malfunctioning detectors overlooked by manual inspection. In practice most TMCs operate in a hybrid fashion, using several elements from the tests described above.

New detector cards which are becoming commercially available can directly output the (digitally sampled) change in inductance. This allows the development of analysis software with considerable more robustness. For example, conventional "threshold" detectors may double (or even triple) count a long truck with many distinct changes in inductive mass. Conventional detectors may double count a vehicle changing lanes between loops, or not count them at all, depending on how sensitive each lane's "threshold" is set. If the base inductance of a loop changes due to mechanical wear or weather induced corrosion, these old threshold detectors must be manually re-calibrated in the field. With the new cards, it appears plausible to develop software to mitigate these types of problems by intelligently interpreting any and all changes in inductance across all the roadway loops at one time. Unfortunately, this capability has not been operationally proven in this country at this time (as of early 1997).

## [Sales](#)

General Information: [Wade](#)

Webmaster: [Steve](#)



This is a secured server site. Your data is safely encrypted and is safe from unauthorized access.



**UPDATE!** Radio Shack has discontinued the 12-603. It has been replaced by the model 12-903. Perhaps the problems described here with the 12-603 have been corrected on the new model - if Radio Shack [provides me with an evaluation unit](#), I will be happy to review it for inclusion in this article. But \$60 is a bit expensive for me - to go buy one just for this article. You can buy a Superadio III (GE 7-2887) from Amazon.com for about \$40.

## Is the Radio Shack Optimus 12-603 the Same as a GE SR 3?

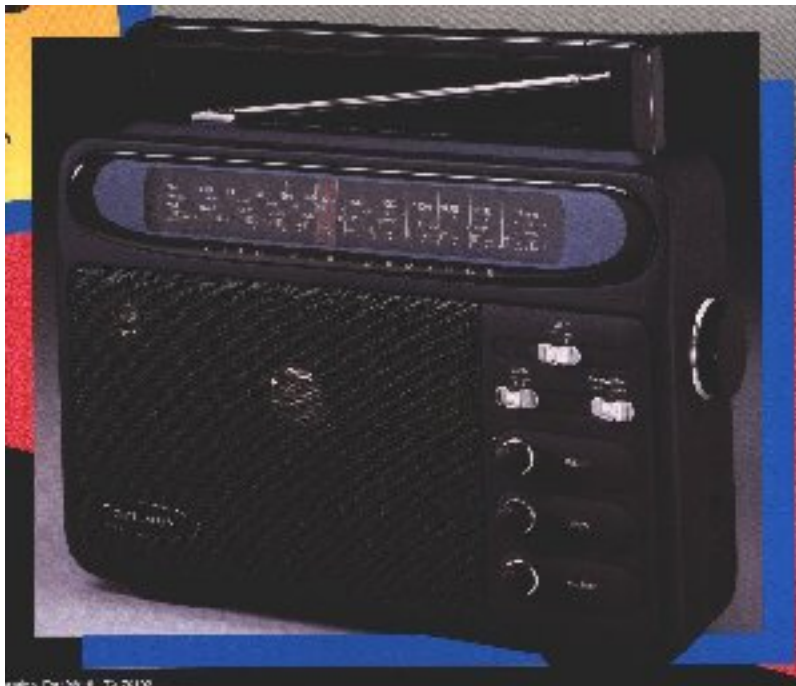

Click on the image above to see an enlarged view ----

Because of the similarity of features and appearance, a lot of people have asked the question above. I am in a position to answer this question, because I own one of each unit. This page is a work in progress, as I had to do a very quick, clandestine analysis. My wife has little understanding of my desire to take apart everything brand new, and "perfectly good". Particularly when it is going to be a Christmas gift for my [daughter](#), her first radio. I had an hour and a half to work on this project before I was in danger of discovery!

The answer to the question is a qualified "NO". The first clue that I had that the two radios were not identical was obvious even in the store. The arrangement of the secondary controls: "AM/FM", "wide/narrow", and "AFC" is different on the SR-3 and the 12-603:

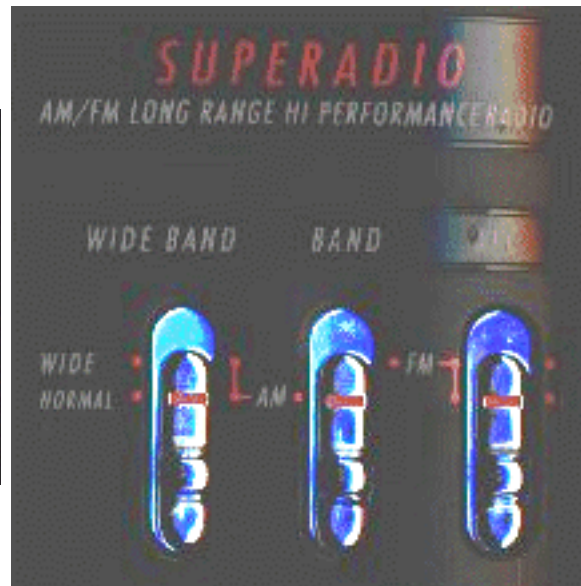
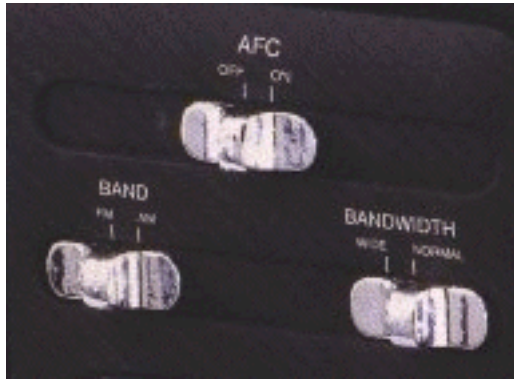

After doing hardware hacking since I was in seventh grade, I knew that the underlying switches would most likely be soldered onto the PC board, rather than connected with wires. This strongly implied that the circuit board layout is different between the two units. This proved to be the case (see below).

One thing that initially caused me to think I had purchased a defective unit: unlike the GE SR-3, the 12-603 includes an "AC/DC" switch on the back. Initially set to the AC position, the switch prevented me from using the radio with batteries (to minimize AC line noise that would enter the unit if I used the AC cord). When switched to the DC position, the radio worked with batteries. This may cause confusion to the user on occasion, resulting in drained / leaking batteries when the radio was supposedly on AC power. One other note related to this switch - it has one of those little dust shields that goes around the shaft inside the radio. I had re-assembled the unit only to find the dust shield sitting on the bench. I then had to take it apart so I could install it, since it will be used by an active child. Of course, after installing the batteries so it would work on Christmas day, I took advantage of the AC/DC switch to insure that the radio would only come on when the package was opened, and not if the box was hit on the switch, draining the batteries before Christmas. So maybe the switch is a good thing after all.

Actually, the Optimus radio is built better than the GE, using thicker, more rugged plastic - reminiscent of the GE SR-2, which I also own. I found myself grateful to Radio Shack for that, as it will be used by an active child. I am getting pretty good at quickly opening Radio Shack radios, after owning several. The front and side knobs should be removed, including the switch latches (unlike the SR-3, where they are underneath the cover). There are six long chassis screws, three on each side, and one short one in the battery compartment. It is not necessary to remove the screws holding the handle.

This is where it gets a little complicated, Radio Shack radios are notorious for needing a little dexterity and having "tricks" to opening. The case separates at the bottom, and it is necessary

to flex the earphone jack side outward a little to clear the earphone jack. Immediately afterwards, the two halves should be manipulated to minimize stress on the on/off switch, located on the top of the unit. After that, the two chassis halves can be separated - and you have access to the inner chassis.

A visual inspection revealed that the 12-603 circuit board is completely different from the SR3:

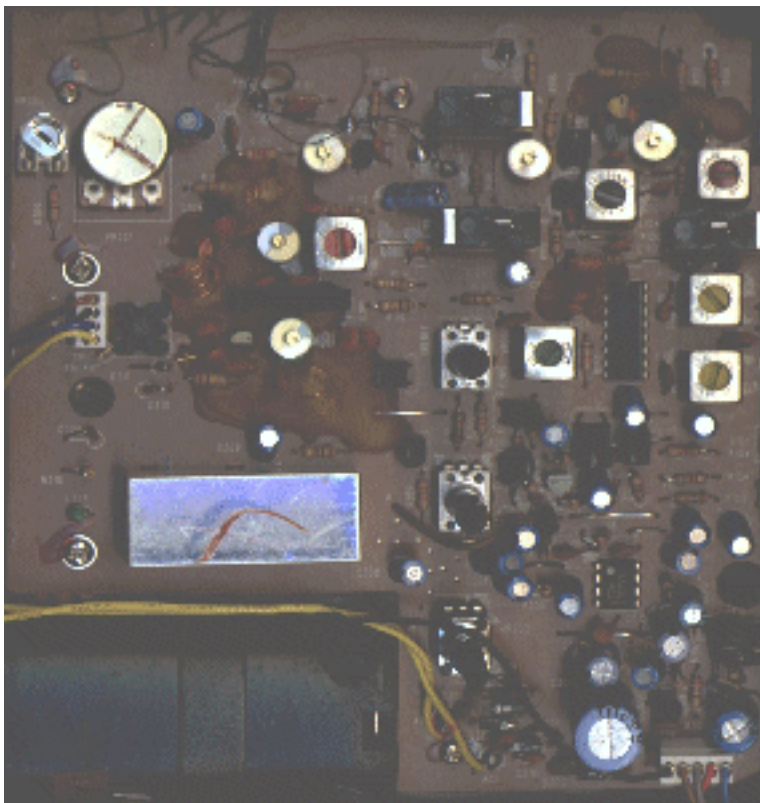

**Optimus 12-603 circuit board**

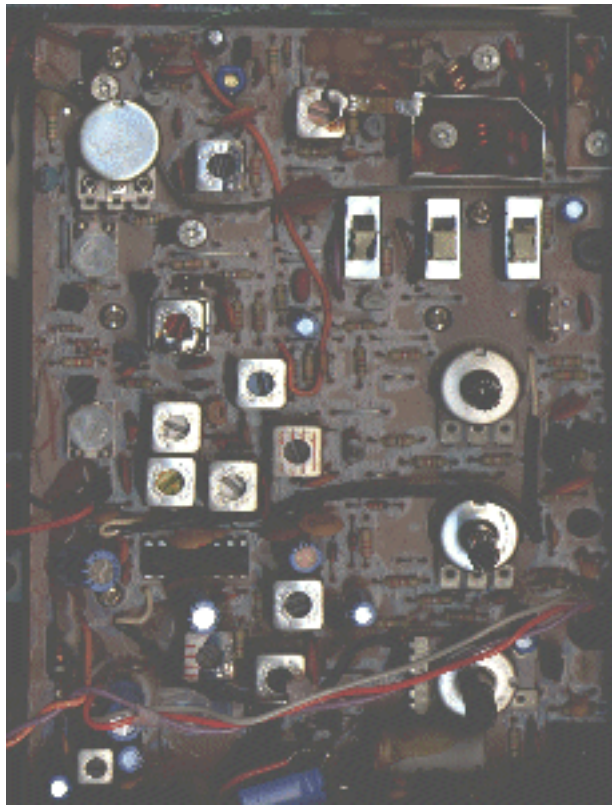

**GE SR-3 circuit board**

Click on either image to get a much larger version, that may be good enough for component identification.

I try very hard not to jump to the "more stuff is better" conclusion - which led me to buy a junky "12 transistor" Jade brand radio in 7th grade, when I should have bought Radio Shack's 8 transistor tuned RF radio instead. But what I see here is many more IF/RF cans on the GE radio, along with many other components. The 12-603 board is open by comparison, but there is a small screened area that could pack a lot of sensitive components inside. There is also one less adjustment in the FM front end, which I will discuss later.

Since the majority of DX'ers will be tempted to purchase the unit for AM reception, I thought that I would concentrate on that aspect. I had been forewarned of the smaller ferrite bar in the 12-603. It is 120 mm instead of 200. This is the United States, this old engineer still thinks of inches instead of mm. So the SR3 has a 7 7/8 inch rod and the 12-603 has a 4 3/4. As almost all of you will know, longer is better - as the ferrite is the only thing that can concentrate flux into the tiny loop antenna. The longer and thicker the rod, the more magnetic flux from the station is transferred to the loop - and the more distant the station that can be received. I have always thought the GE SR3 rod is a bit short for the size of the case. I have a small supply of 10 inch rods. Sadly, I broke my 12 inch rod many years ago. I would have installed a ten inch rod long ago, except the loop diameter is different. I noticed that although Radio Shack retained the loop diameter, they did not use the same quality of loop that GE did. They also omitted the second loop on the opposite end of the rod for external antenna coupling. It made me wonder what the

external AM antenna screw connected to inside the unit - a subject of further exploration when and if I get the opportunity. Naturally, the shorter ferrite rod made the unit's performance suffer greatly compared to the SR-3. There was no point doing a station-by-station comparison, there is simply no competition. A good example is the experimental "traveller's information radio" on 1680 kHz in the Orlando area. A very weak signal on the SR-3, but receivable, it did not even come in at all on the 12-603. Neither did a 530 kHz station from Cuba on the other end of the dial.

FM performance could not be measured directly. I am in a very difficult reception area. Many good stations are crowded onto adjacent channels with stronger stations. That is one reason why I purchased the 12-603. I hoped that it would allow my daughter to hear her beloved [Z88](#), which is intentionally jammed by a mean, spiteful church down the road that insisted on putting a station on an adjacent frequency. This will not be the case, although I will not return the radio just because it is not a good FM performer. The FM performance of the SR-3 is also lackluster. Even if the 12-603 were up to SR-3 standards, it would be asking a lot of manual dexterity and tuning skill from a little girl to reject the garbage from down the street and get Z-88 instead.

The primary reason I could not make direct FM comparisons, however, is that I tend to [swap out the 280 kHz ceramic filters provided in most radios with 150 kHz ceramic filters](#), which dramatically improves selectivity and sensitivity. My SR-3 is no exception. It has a 150 kHz filter in it. I initially planned to do put a 150 kHz filter in the 12-603 so I could make direct comparisons, but it would involve a lot of assembly work, including re-stringing the dial, to get to the back of the circuit board. The other option would be diking the part from the top and cleaning the leads, but that usually entails a risk that you will have to get to the back of the board anyway. I did not have the time - maybe at some future date. I did find a station that was away from strong local signals - and I could make some sensitivity comparisons. I found that the 12-603 brought the station in loud and clear, the same as the SR-3. Another station, however, was not brought in as well.

The next aspect of the question I investigated was the comment that the 12-603 comes poorly aligned, and alignment can improve its performance. I learned many years ago to do "coils low, caps high", and that the tuning dial low and high could be set with the oscillator coil and cap. I don't generally touch FM air coils in wax - too touchy and cranky. The 12-603 has no AM coils for low, so I had to be content with "caps high". I found that the RF cap was slightly off, but the antenna cap was very far off, about 30 degrees brought a dramatic improvement. The AM IF's (3) were slightly off. When touched up, performance improved slightly. Not enough to come anywhere near to the SR-3, or even bring in the weak 1680 kHz station. But enough to increase the volume on a weaker station around 1540 kHz, and bring in a faint signal on the 530 kHz station from Cuba. FM alignment did not yield much improvement, but some. It was closer initially to being correct. I found myself wondering why there was no FM antenna cap, and what sort of improvement it would yield if present. After all, the AM antenna cap yielded the most AM improvement. I am still very interested in seeing what happens when I put in 150 kHz ceramic

filters. Based on memory alone, I think the SR-3 was originally pretty poor as well. If Radio Shack stayed true to form, they put their efforts into FM and skimmed on AM. "Stay tuned", but this is a hobby. It may be while before I try --- But if my daughter whines about Z-88, you can bet I will be doing it quick!

So - the bottom line is - NO, if you are looking for a DX unit "out of the box", and do not want to spend time tinkering. Go to the trouble of finding a genuine SR-3. It is also the latest in a long line of radios that prove that Radio Shack is not really interested in marketing a true AM DX unit to the consumer. In crucial areas like the ferrite bar, they skimp to save money. They concentrate instead on FM, and on the case and exterior.

If you are willing to tinker, use an external antenna, swap out ceramic filters, etc - the jury is still out. It is NOT a re-packaged SR-3 circuit board. It is a totally unique, different design. The potential may or may not be there. In any case, do not buy this unit to DX FM. The SR-2 is a much better portable unit, but any number of car radios, operated off of 9 "D" cells, will give you better portable FM DX.

The 12-603 is still a solid performer, better than standard stuff you can get elsewhere, and worth the sale price of \$40. It will be a good introduction to the world of DX'ing to my daughter - to whom every and any distant station logged will be a new marvel.

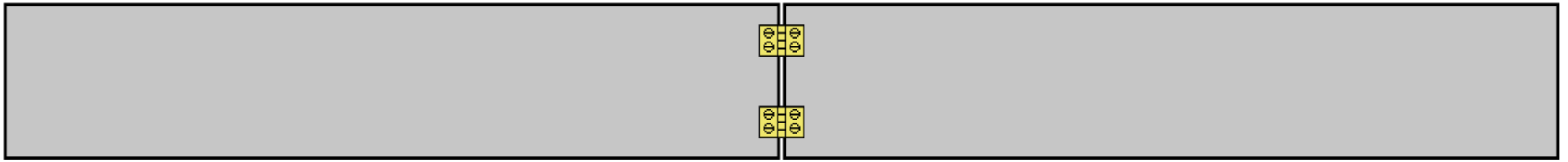

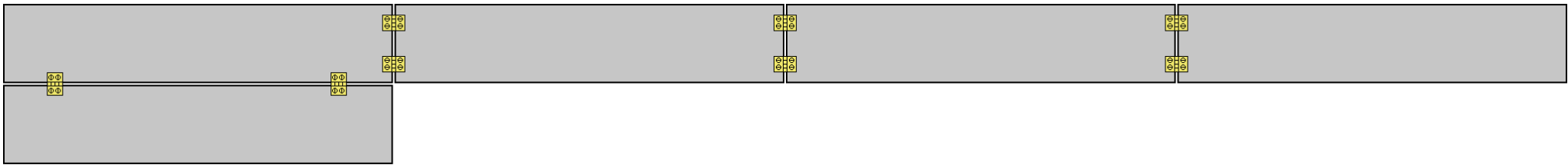



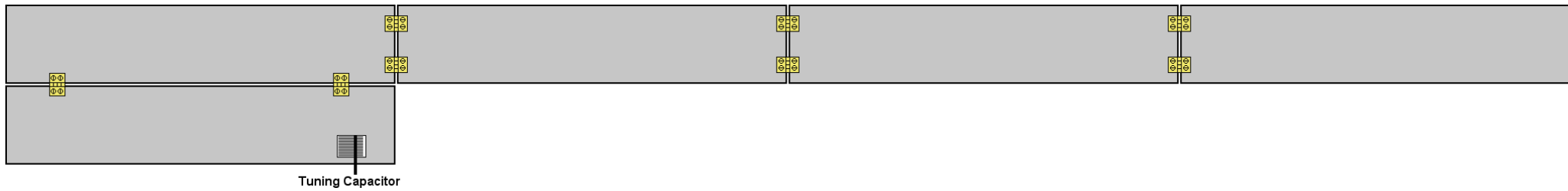



Concert Information and Family Fun

Search the site

where?

for?

[advanced search](#) | [help](#)

Browse the site

**Event Guide**

[calendar search](#)  
[movie showtimes](#)

**Music**

[artist search](#)  
[music store](#)

**Inside kkyx.com**

[contact us](#)

**SA Cooks**

**San Antonio Personals**

**Local Jobs**



Save \$20 on your first purchase at Amazon.com

earn **Free Rewards**

[Learn More](#)

[Privacy Information](#)

Welcome to kkyx.com!

**Artist Search**

**Music search**

Looking for the most amazing music resource on the planet? We have it. In association with Amazon.com, you're able to search for music, then buy it instantly.

**Search by artist:**    **Search by song title:**    **Search by album:**

[help](#) | [search entire site](#)

**Event Best Bets**

- 09/06 [Adam Carroll @ Blue Star Bunkhouse](#)
- 09/06 [Dale Watson @ Continental Club](#)
- 09/08 [Alvin Youngblood Hart @ University Of Texas](#)
- 09/08 [Alvin Youngblood Hart @ Cactus Cafe](#)
- 09/08 [Sister Hazel @ La Zona Rosa](#)  
[more best bets](#)

**Today's bestselling movie DVDs**

1. [The Passion of the Christ \(Widescreen Edition\)](#)
2. [Star Wars Trilogy \(Widescreen Edition\)](#)
3. [The Passion of the Christ \(Full Screen Edition\)](#)
4. [Kill Bill, Volume 2](#)
5. [Fahrenheit 9/11](#)  
[more top sellers](#)

**Top Selling CDs**

1. Loretta Lynn: [Van Lear Rose](#)
2. Junior Brown: [Down Home Chrome](#)
3. Richard Buckner: [Since](#)
4. Willie Nelson: [Stardust](#)
5. Dwight Yoakam: [Very Best of Dwight Yoakam](#)  
[more top sellers](#)

**Featured Album: When Somebody Loves You**



**Artist:** [Alan Jackson](#)  
**List price:** \$13.98  
**Our price:** \$13.98  
[add to cart](#)

[Product details](#) | [Product reviews](#) | [More by this artist](#)

In the decade since his debut, Alan Jackson has matured as both singer and songwriter... [more](#)

**Featured Album: Honkytonkville**



**Artist:** [George Strait](#)  
**List price:** \$13.98  
**Our price:** \$13.98  
[add to cart](#)

[Product details](#) | [Product reviews](#) | [More by this artist](#)

After more than 20 years and 30-plus albums, George Strait might be entitled to cruise... [more](#)

**Shopping Cart**  
[view cart](#)

**Today's Weather**  
Current Temp: 78  
[full forecast](#)

**September events**

S	M	T	W	T	F	S
		1	2	3	4	
5	<a href="#">6</a>	<a href="#">7</a>	<a href="#">8</a>	<a href="#">9</a>	<a href="#">10</a>	<a href="#">11</a>
<a href="#">12</a>	<a href="#">13</a>	<a href="#">14</a>	<a href="#">15</a>	<a href="#">16</a>	<a href="#">17</a>	<a href="#">18</a>
<a href="#">19</a>	<a href="#">20</a>	<a href="#">21</a>	<a href="#">22</a>	<a href="#">23</a>	<a href="#">24</a>	<a href="#">25</a>
<a href="#">26</a>	<a href="#">27</a>	<a href="#">28</a>	<a href="#">29</a>	<a href="#">30</a>		

**Join our email list**

our advertisers:

Free Rewards

Save \$20 on your first purchase

@ Amazon.com



[Learn More](#)

amazon.com  
[Privacy Information](#)



SPONSORED LINKS

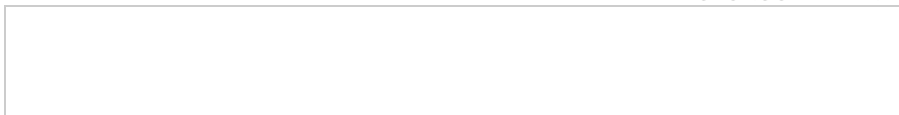

SPONSORED WEB DIRECTORIES

- |                           |                             |                           |                             |
|---------------------------|-----------------------------|---------------------------|-----------------------------|
| <a href="#">Books</a>     | <a href="#">Electronics</a> | <a href="#">Hobbies</a>   | <a href="#">Pets</a>        |
| <a href="#">Cars</a>      | <a href="#">Financial</a>   | <a href="#">Home</a>      | <a href="#">Real Estate</a> |
| <a href="#">Computers</a> | <a href="#">Planning</a>    | <a href="#">Insurance</a> | <a href="#">Software</a>    |
| <a href="#">Education</a> | <a href="#">Gardening</a>   | <a href="#">Internet</a>  | <a href="#">Travel</a>      |
|                           | <a href="#">Gifts</a>       |                           |                             |

 [email this page to a friend](#)  [get a printer-friendly version](#)

[help](#) | [advanced search](#) | [frequently asked questions](#) | [how to advertise](#) | [EEOC statement](#)

Copyright © 2004 Cox Radio Interactive & [Cox Radio, Inc.](#) All rights reserved. [Privacy Policy](#)

By using this website, you accept the terms of our [Visitor Agreement](#). Please read it.

[Shopping](#) is provided in association with amazon.com.

 Portions of Content Provided by All Music Guide © 2004 AEC One Stop Group, Inc. All Music Guide is a registered Trademark of AEC One Stop Group, Inc.